



**SmartGen**  
ideas for power

# HAT520NC

## ATS CONTROLLER

## USER MANUAL

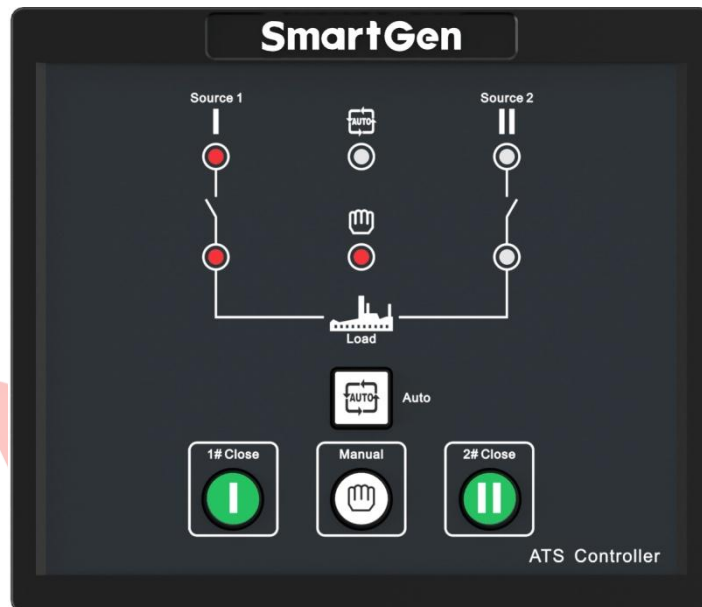

SMARTGEN (ZHENGZHOU) TECHNOLOGY CO., LTD.



Chinese trademark

**SmartGen** English trademark

**SmartGen** — make your generator *smart*

SmartGen Technology Co., Ltd.

No.28 Jinsuo Road

Zhengzhou

Henan Province

P. R. China

Tel: 0086-(0)371-67988888/67981888

0086-(0)371-67991553/67992951

0086-(0)371-67981000(overseas)

Fax: 0086-(0)371-67992952

Web: [www.smartgen.com.cn](http://www.smartgen.com.cn)

[www.smartgen.cn](http://www.smartgen.cn)

Email: [sales@smartgen.cn](mailto:sales@smartgen.cn)

All rights reserved. No part of this publication may be reproduced in any material form (including photocopying or storing in any medium by electronic means or other) without the written permission of the copyright holder.

Applications for the copyright holder's written permission to reproduce any part of this publication should be addressed to Smartgen Technology at the address above.

Any reference to trademarked product names used within this publication is owned by their respective companies.

SmartGen Technology reserves the right to change the contents of this document without prior notice.

Table 1 Software Version

Date	Version	Note
2020-03-02	1.0	Original release.
2020-03-13	1.1	Changed application diagram.
2020-04-16	1.2	Add auto transfer auto restore/auto transfer non-restore function description.
2020-06-05	1.3	Add auto transfer auto restore/auto transfer non-restore parameters instruction for panel setting steps.

## CONTENT

1	OVERVIEW .....	4
2	PERFORMANCE AND CHARACTERISTICS .....	4
3	SPECIFICATION.....	5
4	PANEL DESCRIPTION.....	6
	4.1 PANEL OPERATION.....	6
	4.2 INDICATOR LIGHT FUNCTION DESCRIPTION .....	6
5	PANEL BUTTON OPERATION .....	7
	5.1 PANEL BUTTON OPERATION.....	7
	5.2 MASTER SETTING.....	7
	5.3 AC SYSTEM SETTING.....	8
	5.4 DELAY ADJUSTMENT.....	9
	5.5 RESTORE FACTORY DEFAULT.....	9
	5.6 AUTO TRANS. AUTO RESTORE SETTING.....	9
6	PROGRAMMED PARAMETER AND RANGE .....	10
7	OPERATION CONTROL .....	12
8	WIRE CONNECTION.....	13
	8.1 DESCRIPTION OF CONNECTING TERMINALS .....	13
	8.2 RS485 CONNECTION DESCRIPTION .....	14
9	TYPICAL WIRING DIAGRAM.....	15
10	INSTALLATION .....	17
11	FAULT FINDING .....	17

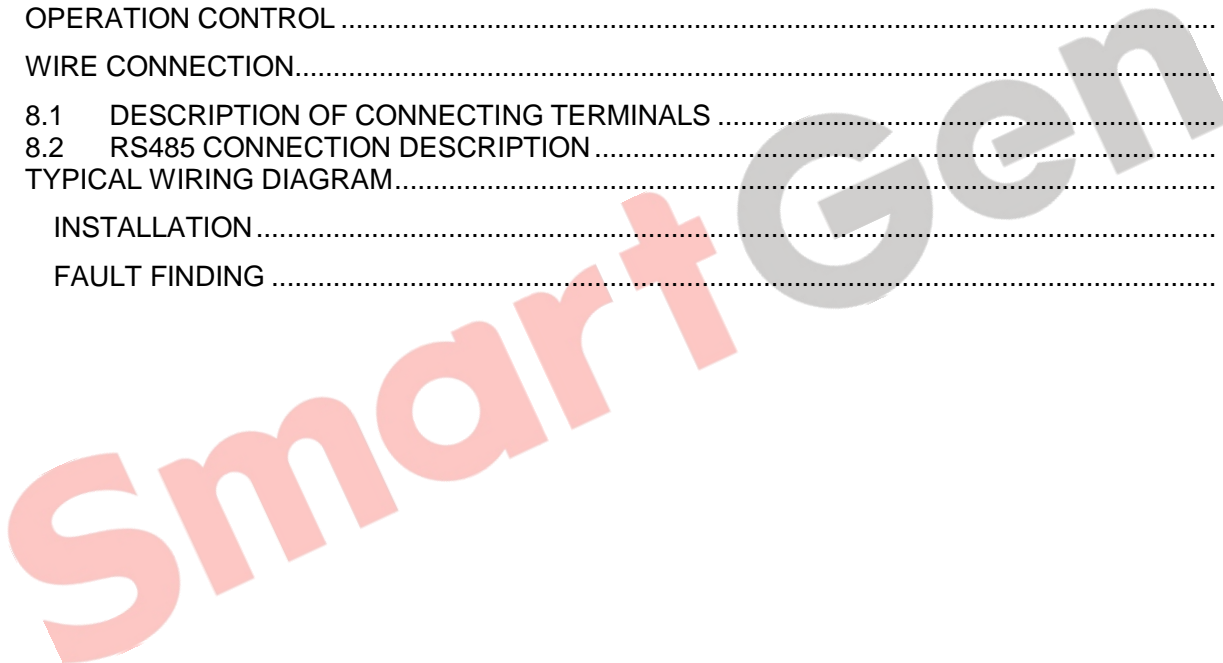

## 1 OVERVIEW

**HAT520NC ATS Controller** is composed of the core microprocessor, which can precisely measure 3 phase/single phase voltage of 2 ways, make accurate judgment on abnormal voltages (power lost, over/under voltage, over/under frequency, loss of phase, phase sequence wrong), and control ATS to transfer after the delay has expired. It is suitable for No breaking ATS. When 1# power is abnormal, controller can send signal to start genset after the "1# abnormal delay" has expired. "Three remotes" (remote control, remote measurement, and remote communication) function can be implemented via RS485 communication port.

## 2 PERFORMANCE AND CHARACTERISTICS

Controller performance and characteristics are shown as below:

- Measure and display 2-way 3-phase Voltage and Frequency:
 

1#	2#
Line voltage (Uab, Ubc, Uca)	Line voltage (Uab, Ubc, Uca)
Phase voltage (Ua, Ub, Uc)	Phase voltage (Ua, Ub, Uc)
Frequency Hz	Frequency Hz
- Over/under voltage, loss of phase, phase sequence wrong, over/under frequency detection function. As default, phase sequence wrong and over/under frequency detection are disable; however, users can set the function as you need.
- RS485 communication port (SmartGen SG72 adaptor is needed). It can realize controller parameter configuration function and it also can realize firmware update of controller.
- The normal delay of 1# or 2# power can be set (Range: 0~60s) and the Genset start delay can be set (Range: 0~3600s).
- The abnormal delay of 1# or 2# power can be set (Range: 0~60s) and the Genset stop delay can be set (Range: 0~3600s).
- "1# Master", "Each Backup" and "2# Master" can be set via controller front panel, to realize 1# master power supply, 2# master power supply, or backup supply methods for each other to supply power.
- Close output signal can be set as on intervals or as continuous output.
- 2-way N line isolated design.
- Auto/Manual mode transfer. In manual mode, ATS transfer 1# switch or 2# switch can be implemented via panel pushbutton.
- LEDs mounted on front panel can clearly show ATS running status.
- The output contactor capacity of 1# and 2# power supply transfer relay (1# CLOSE, 2# CLOSE) is 16A AC250V, volts-free contact, can be directly used in driving switch to transfer etc.
- The output contactor capacity of Genset start relay (GENS START) is 7A AC250V/7A DC28V, volts-free Normally Close contact.
- Suitable for various AC systems (3-phase 4-wire, 2-phase 3-wire and single-phase 2-wire).
- Modular design, flame retardant ABS plastic shell, pluggable terminal, built-in mounting, compact structure with easy installation.

### 3 SPECIFICATION

Table 2 Technical Parameters

Items	Contents
Operating Voltage	AC170V~277V during AC power L1N1/L2N2 supply.
Power Consumption	<2W (Standby mode: <1W)
AC Voltage Input	
3P4W (ph-N)	AC170V~AC277V(ph-N)
1P2W (ph-N)	AC170V~AC277V (ph-N)
2P3W (ph-N)	AC170V~AC277V(ph-N)
Rated Frequency	50/60Hz
1# Close Relay Output	16A AC250V Volts free output
2# Close Relay Output	16A AC250V Volts free output
Gen Start Relay	7A AC250V Volts free output
1# Close Input	COM connected is active.
2# Close Input	COM connected is active.
Communication	RS485 Port, MODBUS Protocol
Case Dimensions	139mmx120mmx50mm
Panel Cutout	130mmx111mm
Working Conditions	Temperature: (-25~+70)°C; Humidity: (20~93)%RH
Storage Condition	Temperature: (-30~+80)°C
Protection Level	IP65: when waterproof gasket installed between controller and the control window;
Insulation Strength	Apply AC1.5kV voltage between high voltage terminal and low voltage terminal and the leakage current is not more than 3mA within 1min.
Weight	0.49kg

## 4 PANEL DESCRIPTION

### 4.1 PANEL OPERATION

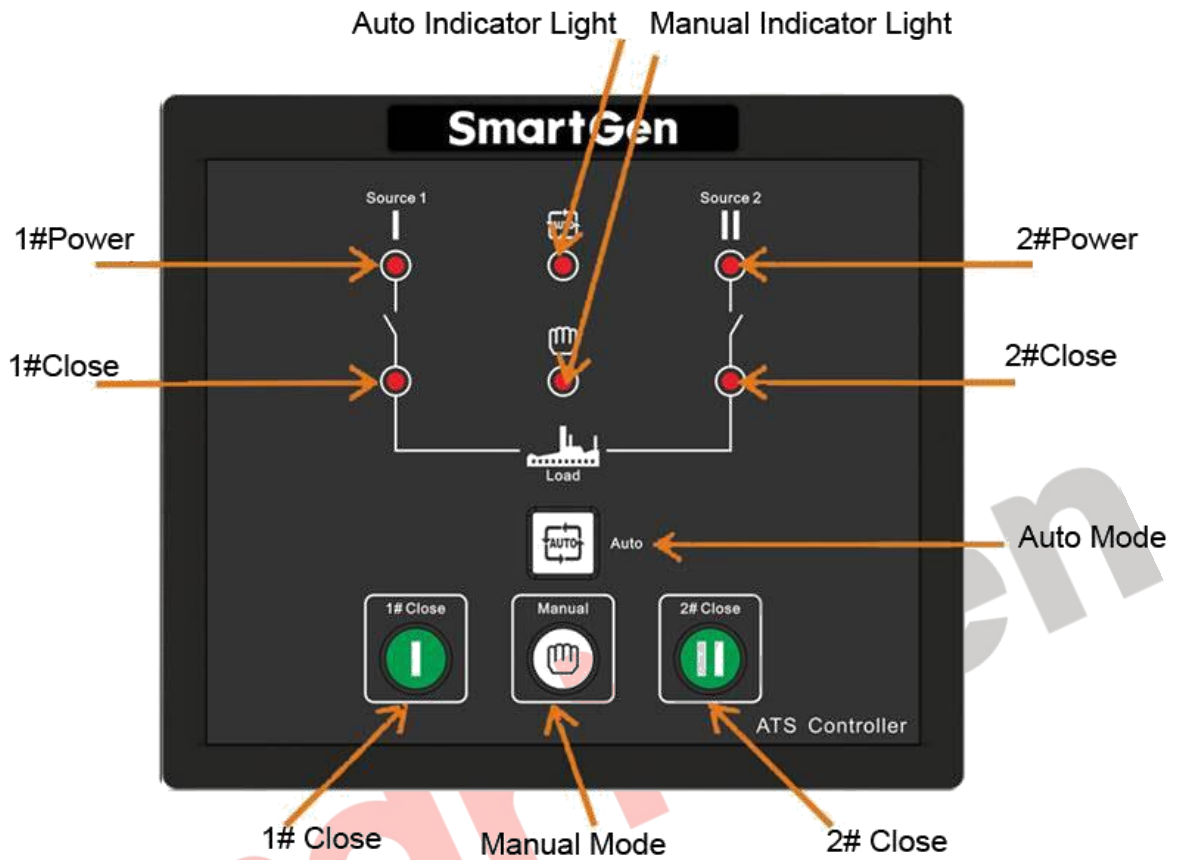

Fig. 1 HAT520NC Panel Description

### 4.2 INDICATOR LIGHT FUNCTION DESCRIPTION

Table 3 Indicators Function Description in normal testing mode





Indicator Light	Function Description
1# Power Indicator	It is illuminated when 1# power is normal; flashing when 1# power state is abnormal; off when there is no 1# power.
2#Power Indicator	It is illuminated when 2# power is normal; flashing when 2# power state is abnormal; off when there is no 2# power.
1# Close Indicator	It is illuminated when 1# power auxiliary contactor is active while off when it is deactivated.
2# Close Indicator	It is illuminated when 2# power auxiliary contactor is active while off when it is deactivated.
Auto Mode Indicator	It is illuminated when the controller is in auto mode while off when the controller is in manual mode.
Manual Mode Indicator	It is illuminated when the controller is in manual mode while off when the controller is in auto mode.

**NOTE:** Indicators Description after setting the parameters: More details please refer to the following description of

“Panel Button Operation”.

## 5 PANEL BUTTON OPERATION





### 5.1 PANEL BUTTON OPERATION

Pressing and holding the  button for more than 3s, all LEDs are illuminated to enter into lamp test mode; Keep pressing  and don't release, after 7s all LEDs are flashing (once per 500ms) to enter parameter setting status, and release the button; At this time if users don't plan to set parameters, press  button, and all LEDs flash rapidly for 5 times (once per 200ms) to return back to normal testing mode. At the status of lamp test, release  button and controller goes back to normal testing mode. After entering parameter setting status, if parameters are not set, controller will automatically go back to normal testing mode after about 1 minute and 30 seconds.

### 5.2 MASTER SETTING

First of all make controller enter parameter setting status, and then conduct the settings.

Procedures of setting “1# Master”, “2# Master” and “Each Backup”:

- a) Press ,  and  at the same time, when 1#/#2 power indicator and auto indicator are illuminated; release the three buttons, then the auto indicator and 2# power indicators extinguish, 1# power indicator illuminates, which means controller master setting status is entered.
- b) Pressing  can circularly set 3 conditions of power supply.  
**1# Master:** 1# power indicator illuminates and 2# power indicator extinguishes;  
**2# Master:** 2# power indicator illuminates and 1# power indicator extinguishes;  
**Each Backup:** 1# power and 2# power indicators are illuminating at the same time;
- c) After adjusting, press , when 1# power indicator, auto indicator and 2# power indicator are illuminating, the adjusted master power value has been saved. The controller will go back to normal status automatically after all LEDs are flashing 5 times rapidly and controller will work according to the set master status.







**▲NOTE:** Once the controller is power on, master status can be judged by the following three conditions.

- If 1# power supply indicator flashes rapidly for three times, it indicates 1# power supply is master.
- If 2# power supply indicator flashes rapidly for three times, it indicates 2# power supply is master.
- If 1# and 2# power supply indicators flash simultaneously for three times, it indicates it is each backup.

### 5.3 AC SYSTEM SETTING

First of all make controller enter parameter setting status, and then conduct the settings.

Procedures of setting “single-phase 2-wire”, “3-phase 4-wire” and “2-phase 3-wire”:

- a) Press ,  and  at the same time, when 1#/2# power indicator and auto indicator are illuminated; release the three buttons, then the auto indicator and 2# power indicators extinguish, 1# power indicator illuminates.
- b) Press , when 1#/2# power indicator and auto indicator are illuminated; release the button, then the auto indicator and 1#/2# power indicators are extinguished simultaneously, which means controller AC system setting status is entered.
- c) Pressing  can circularly set three AC systems.
  - **Single-phase 2-wire:** 1# close indicator illuminates;
  - **3-phase 4-wire:** 1# close indicator, 2# close indicator and manual mode indicator illuminates simultaneously;
  - **2-phase 3-wire:** 1# close indicator and manual mode indicator illuminates simultaneously;
- d) After adjusting, press , when 1# power indicator, auto indicator and 2#power indicator are illuminating, the adjusted AC system has been saved. The controller will go back to normal status automatically after all LEDs are flashing 5 times rapidly and controller will work according to the set AC system.

**▲NOTE:** Once the controller is power on, its AC system can be judged by the following three conditions.

- If 1# close indicator illuminates, it means **Single-phase 2-wire** system is selected.
- If 1# close indicator, manual mode indicator and 2# close indicator illuminate simultaneously, it means **3-phase 4-wire** system is selected.
- If 1# close indicator and manual mode indicator illuminate simultaneously, it means **2-phase 3-wire** system is selected.





## 5.4 DELAY ADJUSTMENT

Adjusting “1# power normal delay” potentiometer (locate nearby the back panel terminal) can set output delay after 1# power supply is normal.

Adjusting “2# power normal delay” potentiometer (locate nearby the back panel terminal) can set output delay after 2# power supply is normal.

First of all make controller enter parameter setting status, and then conduct the settings.

Setting Procedures of “1# power abnormal delay” and “2# power abnormal delay”:

- a) Press  and  at the same time, when 1#/2# power indicator and auto indicator are illuminated; release the two buttons, then the auto indicator and 1#/2# power indicators are extinguished simultaneously which means the delay timer of the controller can be set.

1# power abnormal delay: adjust “1# Power Normal Delay” potentiometer;



2# power abnormal delay: adjust “2# Power Normal Delay” potentiometer;

- b) After adjusting the delays, press . When 1#/2# power indicator and automatic indicator are illuminated simultaneously, the adjusted value has been saved. The controller will go back to normal status automatically after all LEDs are flashing 5 times rapidly and controller will work according to the set delay values.

**▲NOTE:** 1# Normal Delay set value must be no less than 1# Abnormal Delay, otherwise, 1# Normal Delay set value will be forced to be set as 1# Abnormal Delay set value. 2# Normal Delay set value shall be no less than 2# Abnormal Delay set value, otherwise 2# Normal Delay set value will be forced to set as 2# Abnormal Delay set value.

## 5.5 RESTORE FACTORY DEFAULT

First of all make controller enter parameter setting status, and then conduct the settings.

- a) Press  and  at the same time, when 1#/2# power indicator and auto indicator are illuminated; release the two buttons, then the auto indicator and 1#/2# power indicators are extinguished simultaneously, which means the default delay value of the controller can be set.



- b) Press , when 1#/2# power indicators and auto indicator are illuminated simultaneously, the factory default has been restored. The controller will go back to normal testing status automatically after all LEDs flash 5 times rapidly and controller will work according to the set delay values.

**▲ NOTE:** By default, 1# and 2# abnormal delay is 5s and genset stop delay is 90s.

## 5.6 AUTO TRANS. AUTO RESTORE SETTING

First of all, make controller enter parameter setting status and then conduct the setting.

Set “Auto Trans. Auto Restore/Auto Trans. Non-Restore” Steps:

a) Press  and  at the same time, when 1#/2# power indicators and auto indicator are illuminated, release the two buttons, then the auto indicator and 2# power indicator are extinguished, 1# power indicator and 1# close indicator are illuminated, which means the auto trans. auto restore of the controller can be set.

b) Press  can circularly set two states:

Auto trans. non-restore when 1# power indicator and 1# close indicator are illuminated, 2# power indicator and 2# close indicator are extinguished.

Auto trans. auto restore when 2# power indicator and 2# close indicator are illuminated, 1# power indicator and 1# close indicator are extinguished.

c) After adjustment, press . When the 1#/2# power indicators and auto indicator are illuminated at the same time, it indicates that the set parameter value has been saved successfully; all indicators on the panel flash 5 times quickly to return to normal test mode. The controller works according to the set state of auto trans. auto-restore/auto trans. non-restore.

**▲NOTE:** Turn on the power supply of the controller, auto trans. auto-restore/auto trans. non-restore set by the controller can be judged by the following two situations:

If 1# power indicator and 1# close indicator flash quickly three times at the same time, it is auto trans. non-restore.

If 2# power indicator and 2# close indicator flash quickly three times at the same time, it is auto trans. auto restore.

## 6 PROGRAMMED PARAMETER AND RANGE

Table 4 Parameter Configuration

No.	Item	Range	Default	Description
01	1# Normal Delay	(0-60)s	Can be set via controller potentiometer	It is the delay of 1# power from voltage abnormal to voltage normal. Generally, it is 10s.
02	1# Abnormal Delay	(0-60)s	5	It is the delay of 1# power from voltage normal to voltage abnormal.
03	2# Normal Delay	(0-60)s	Can be set via controller potentiometer	It is the delay of 2# power from voltage abnormal to voltage normal. Generally, it is 10s.
04	2# Abnormal Delay	(0-60)s	5	It is the delay of 1# power from voltage normal to voltage abnormal.
05	Close Delay	(0-20)s	5	Pulse time for close relay; If set it to 0, it is continuous output.
06	Exceed Transfer	(0-20.0)s	0.0	It is the extra output delay of the close relay after the close signal has been received.
07	Start Delay	(0-3600)s	1	When voltage is abnormal, start delay begins; start signal is initiated after the delay has expired.
08	Stop Delay	(0-3600)s	90	At genset starting, if Mains voltage is normal,



No.	Item	Range	Default	Description
				stop delay begins; after the delay, close genset start signal;
09	AC System	(0-2)	0	0. 3-phase 4-wire 1. 2-phase 3-wire 2. Single phase 2-wire
10	Rated Volt	(100-240)V	230	AC system rated voltage.
11	Rated Frequency	(50.0-60.0)Hz	50.0	To offer standards for detecting over/under frequency.
12	Over Volt Enable	(0-1)	1	0: Disable; 1: Enable
13	Over Voltage	(100-120%)	115	Voltage upper limit; it is abnormal when the voltage has exceed the set value.
14	Over Voltage Return	(100-120%)	113	Voltage upper limit return value; it is normal only when the voltage falls below the set value.
15	Under voltage	(70-100%)	75	Voltage lower limit; it is abnormal when the voltage has fallen below the set value.
16	Under Voltage Return	(70-100%)	77	Voltage lower limit return value; it is normal only when the voltage has exceeded the set value.
17	Over Freq Enable	(0-1)	0	0: Disable; 1: Enable
18	Over Frequency	(100-120%)	110	Frequency upper limit; it is abnormal when the frequency has exceed the set value.
19	Over Frequency Return	(100-120%)	104	Frequency upper limit return value; it is normal only when the frequency falls below the set value.
20	Under Freq Enable	(0-1)	0	0: Disable; 1: Enable
21	Under Frequency	(80-100%)	90	Frequency lower limit; it is abnormal when the frequency has fallen below the set value.
22	Under Frequency Return	(80-100%)	96	Frequency lower limit return value; it is normal only when the frequency has exceeded the set value.
23	Loss of Phase	(0-1)	1	0: Disable; 1: Enable
24	Phase Sequence Wrong	(0-1)	0	0: Disable; 1: Enable
25	Master-Slave Set	(0-2)	0	0. 1# Master; 1. 2# Master; 2. Each Backup
26	Auto Trans./Auto Restore	(0-1)	1	0: Auto Trans. Non-Restore 1: Auto Trans. Auto Restore

**NOTE1:** Parameters above are configured by SmartGen PC software. PC programming connection: connect RS485 interface of SG72 and controller RS485.

**NOTE2:** "1# Normal Delay" and "2# Normal Delay" can be set only via the potentiometer which locates nearby the back panel terminal. "1# Abnormal Delay" and "2# Abnormal Delay" can be set via the PC software or potentiometer

which locates nearby the back panel terminal. AC system and priority selection can be set via panel button or PC software while other parameters can be set via PC software only.



**NOTE3:** 1# Normal Delay set value mustn't be less than 1# Abnormal Delay, otherwise, 1# Normal Delay set value will be forced to be set as 1# Abnormal Delay set value. 2# Normal Delay set value shall be over or equal to 2# Abnormal Delay set value, otherwise 2# Normal Delay set value will be forced to be set as 2# Abnormal Delay set value. If motor driving type ATS (e.g. SOCOMEC VS) is applied, the Close delay and Open delay mustn't be less than 5s; If magnet driving type ATS (e.g. SGQ-N) is applied, the Exceed Transfer delay must be set as 0.

**NOTE4:** "Priority Select" in last version is changed to "Master-Slave Set"; Set contents "0: 1# Priority; 1: 2# Priority; 2: NO Priority" are changed to "0: 1# Master; 1: 2# Master; 2: Backup".

## 7 OPERATION CONTROL

When controller is running, pressing  key can set the controller to Auto mode and auto status

indicator is illuminated. Pressing  key can set the controller to Manual mode and manual status indicator is illuminated. In auto mode, controller can automatically transfer load to 1# power supply or 2# power supply. When it is set to Auto Transfer Auto Restore, master power is normal, and controller will transfer to master power in priority. When it is set to Auto Transfer Non-Restore, controller only transfer to backup power, and master power transfer can only be controlled manually. Each Backup is mutually backed up for dual power sources. When 1# power is abnormal, and 2# is normal, switch will transfer to 2# power supply, and vice versa. When it is set to Each Backup, controller will not detect Auto Transfer Auto Restore settings.

In Manual mode, press  key and load will be transferred to 1# power supply; press  key and load will be transferred to 2# power supply.

**8 WIRE CONNECTION**

**8.1 DESCRIPTION OF CONNECTING TERMINALS**

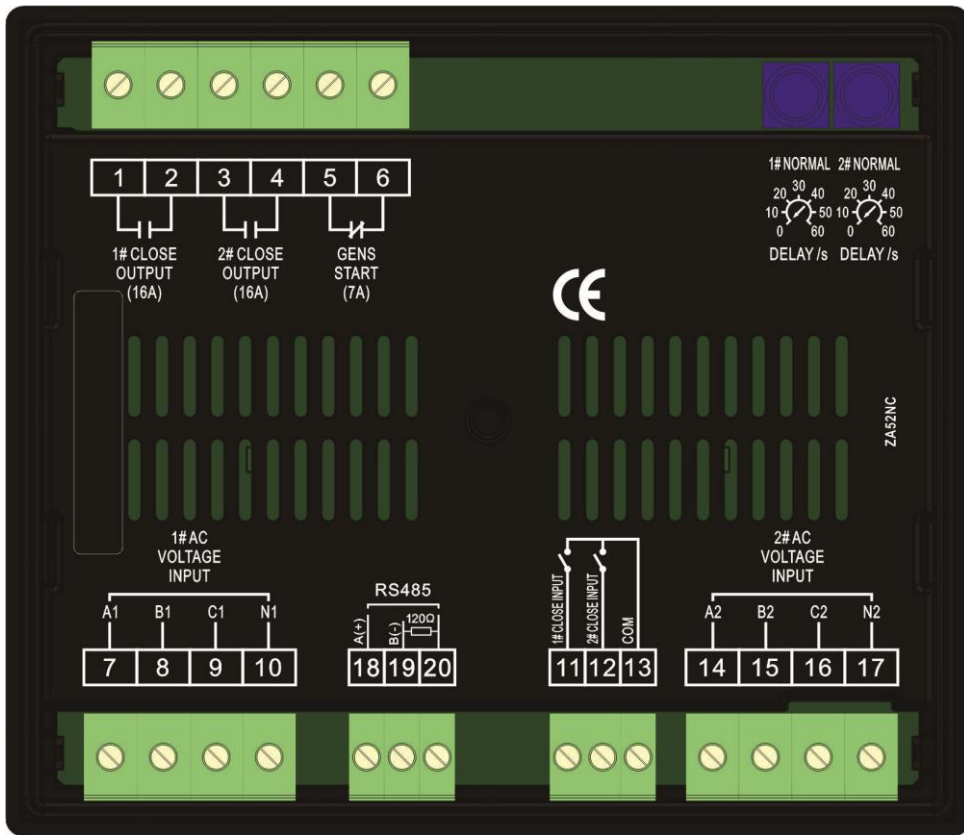

Fig. 2 HAT520NC Back Panel

Table 5 Terminal Function Description

No.	Items	Description	Remark
1	1# Close Output	Volt-free relay contact output	N/O contact output; rated 16A.
2			
3	2# Close Output	Volt-free relay contact output	N/O contact output; rated 16A.
4			
5	Gens Start	Volt-free relay contact output	N/C contact output; rated 7A.
6			
7	A1	1# AC 3-phase 4 wire voltage input	For single phase, only connect A1, N1.
8	B1		
9	C1		
10	N1		
11	1# Close Input	Detection of 1# ATS closing status; auxiliary contact input	Connect COM is active.
12	2# Close Input	Detection of 2# ATS closing status; auxiliary contact input	Connect COM is active.
13	COM	COM	
14	A2	2# AC 3-phase 4 wire voltage input	For single phase, only connect A2, N2.
15	B2		
16	C2		
17	N2		
18	A(+)	RS485 communication port	Inside already connected 120Ω impedance matched resistor
19	B(-)		
20	120Ω Resistor	RS485 impedance matched resistor	Users need to make this connected with terminal No. 18 based on field network, used for connecting inside 120Ω resistor;

### 8.2 RS485 CONNECTION DESCRIPTION

Connection between RS485 and adaptor is as below:

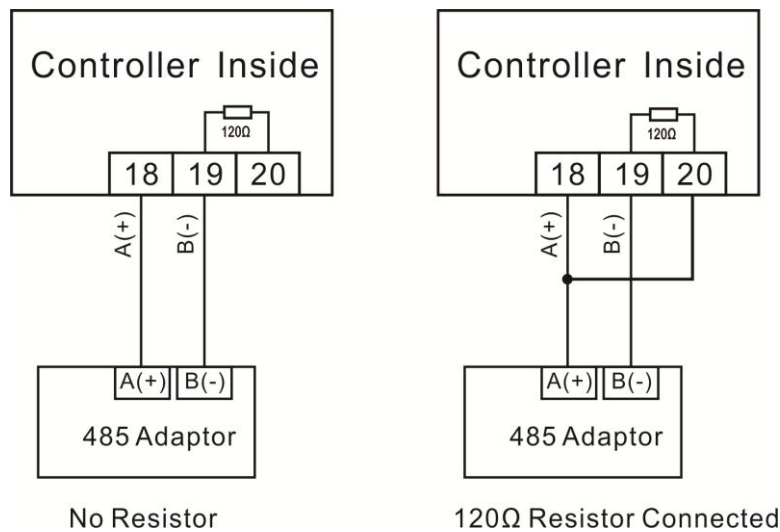

Fig. 3 RS485 Connection

9 TYPICAL WIRING DIAGRAM

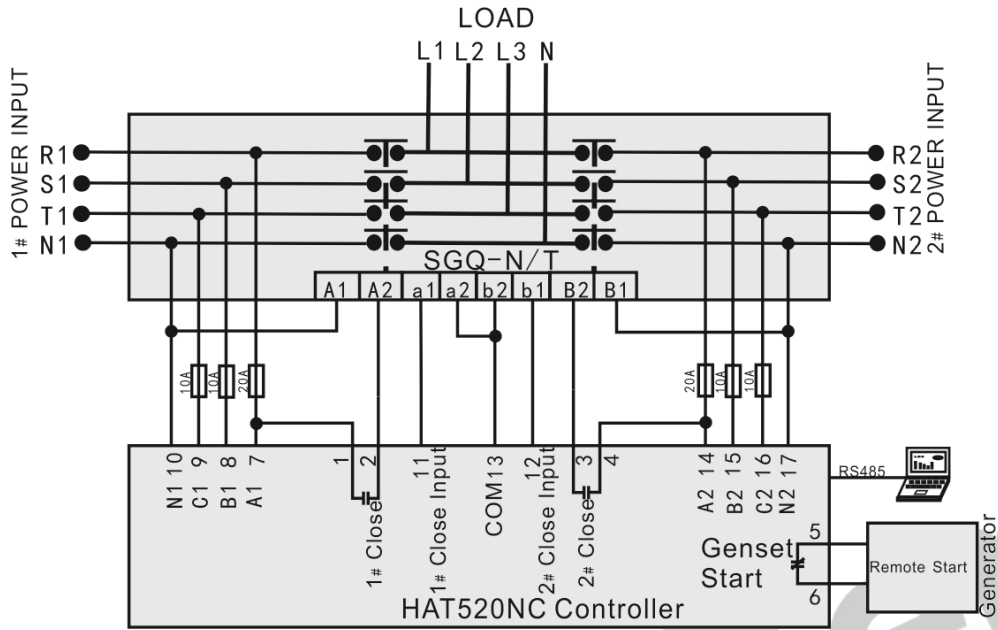

Fig. 4 SGQ-N/T Wiring Diagram

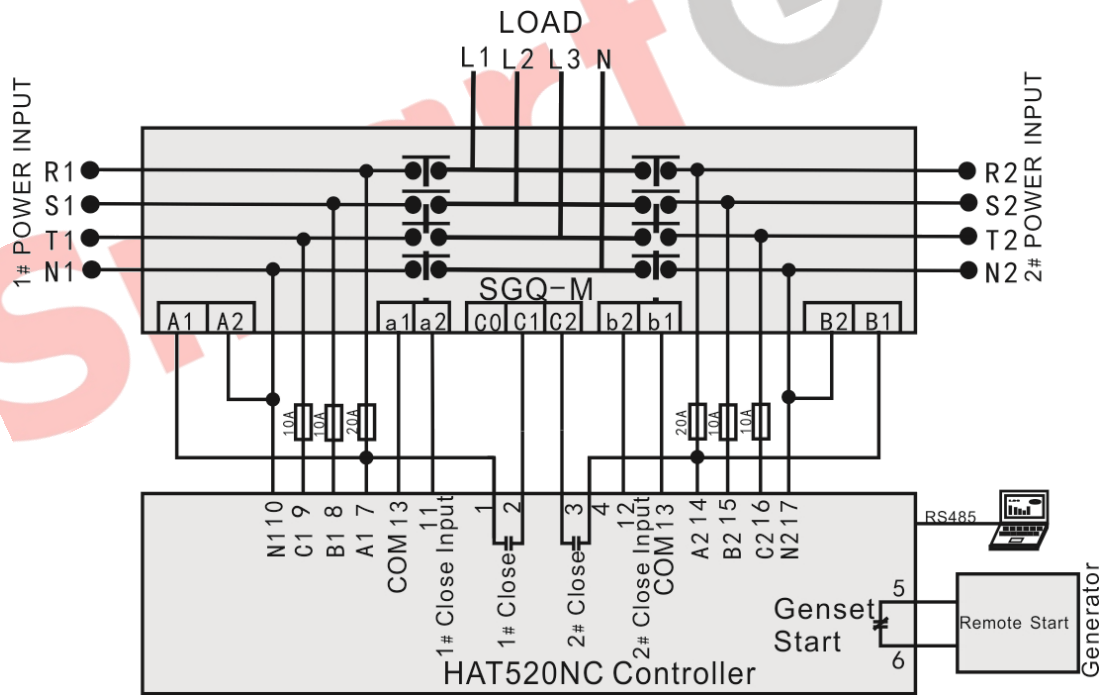

Fig. 5 SGQ-M Wiring Diagram

**NOTE:** The diagram is for reference only. The actual wiring shall follow the ATS instruction. Users should choose proper fuse capacity according to the actual power consumption. Please don't take the fuse in the diagram above as standard.



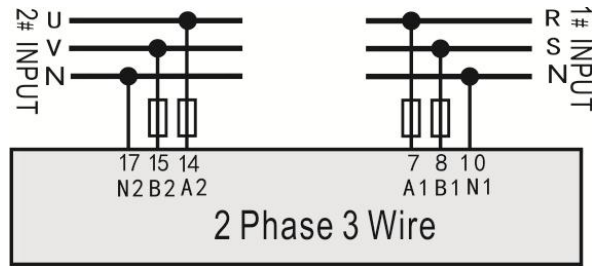

Fig. 6 2-phase 3-wire Wiring Diagram

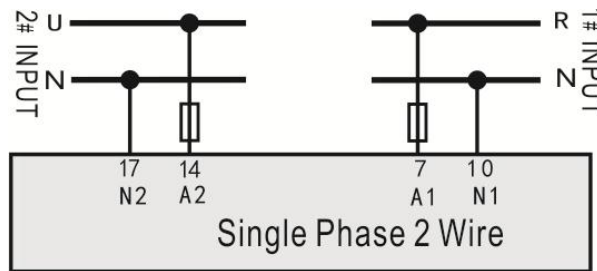
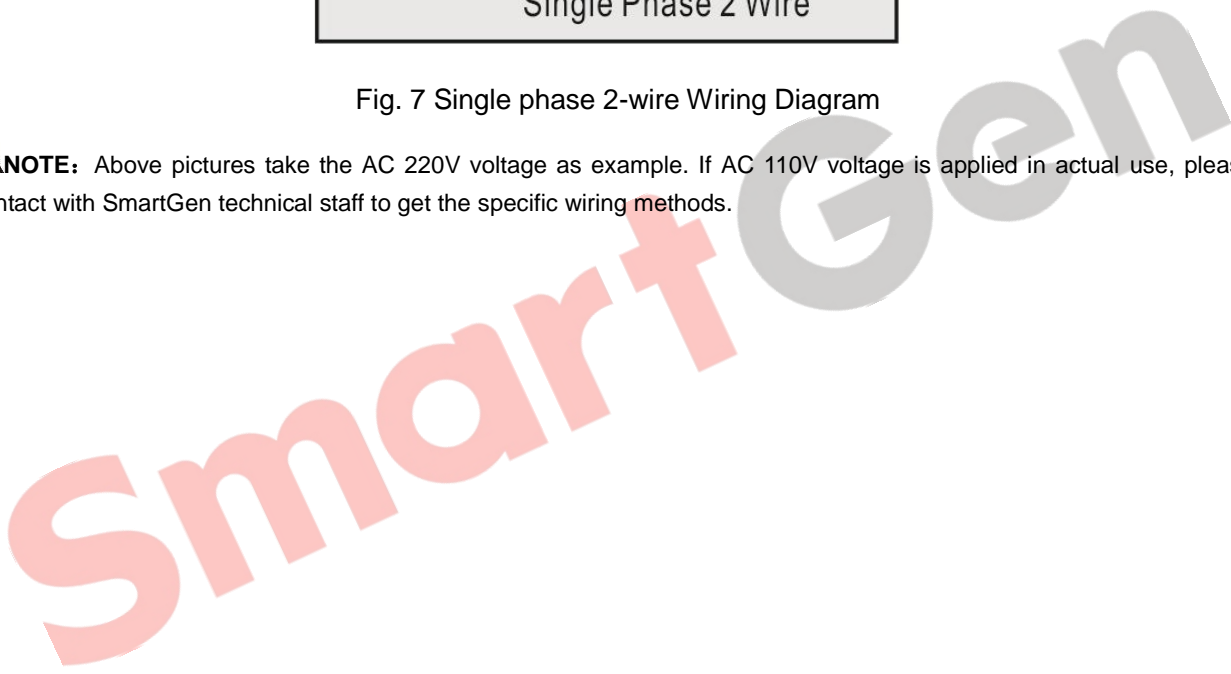

Fig. 7 Single phase 2-wire Wiring Diagram

**NOTE:** Above pictures take the AC 220V voltage as example. If AC 110V voltage is applied in actual use, please contact with SmartGen technical staff to get the specific wiring methods.





## 10 INSTALLATION

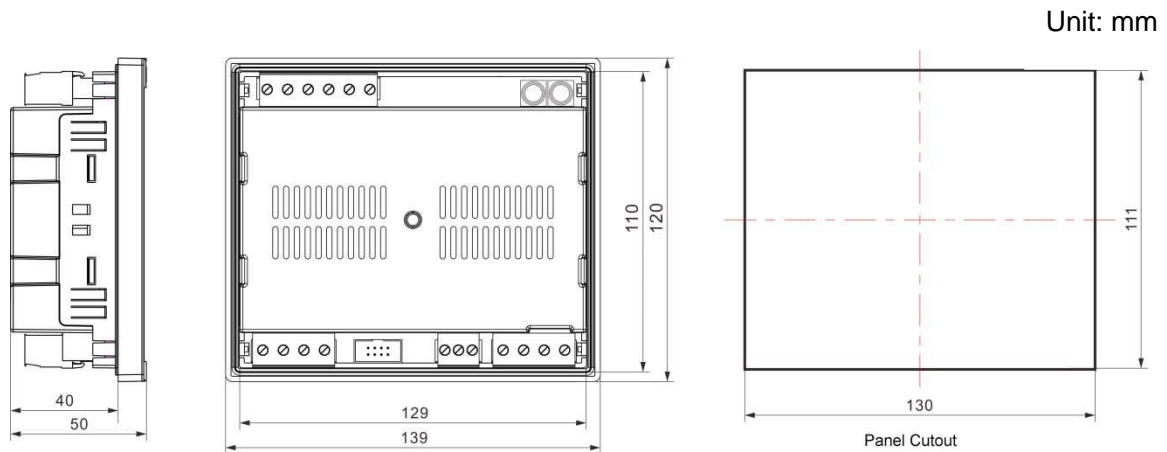

Fig. 8 Installation Dimension

## 11 FAULT FINDING

Table 6 Common Faults

Symptom	Possible Solutions
Controller no response with power.	Check controller wiring connections;
Genset running while ATS not transfer	Check ATS; Check the connection wirings between the controller and the ATS.
Electrical parameters detection error	Check controller wiring; Modify electrical parameters detection value;
PC software communication failure	Check communication port setting and connections.