

# Smartgen®

## HAT520 ATS CONTROLLER

### USER MANUAL

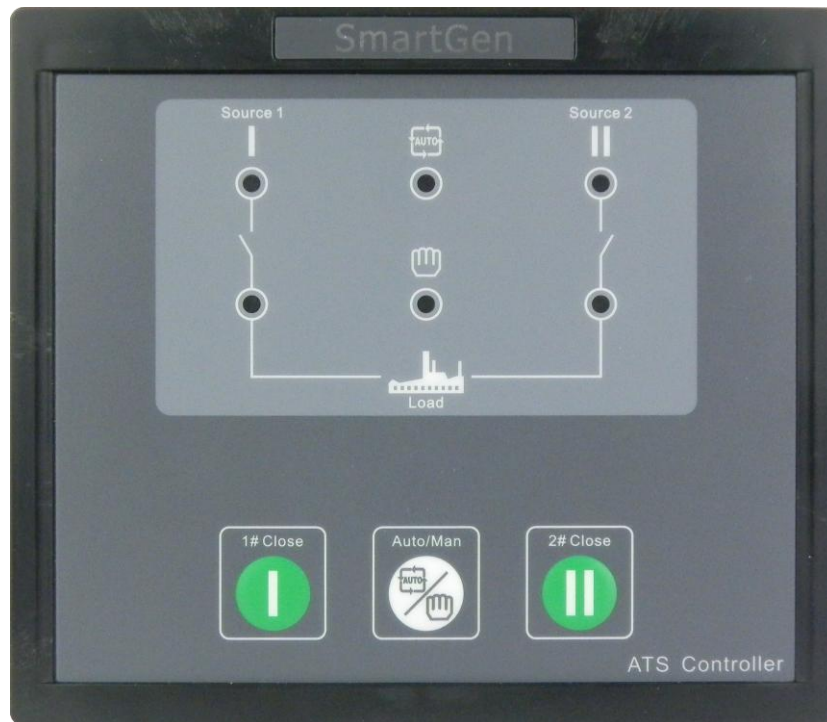

Smartgen Technology



众智电子 Chinese trademark

**Smartgen**<sup>®</sup> English trademark

**Smartgen** — make your generator *smart*

**Smartgen Technology Co., Ltd.**

**No. 28 Jinsuo Road**

**Zhengzhou City**

**Henan Province**

**P. R. China**

**Tel: +86-371-67988888**

+86-371-67981888

+86-371-67991553

+86-371-67992951

+86-371-67981000(overseas)

**Fax: 0086-371-67992952**

**Web:** <http://www.smartgen.com.cn/>

<http://www.smartgen.cn/>

**Email:** [sales@smartgen.cn](mailto:sales@smartgen.cn)

All rights reserved. No part of this publication may be reproduced in any material form (including photocopying or storing in any medium by electronic means or other) without the written permission of the copyright holder.

Smartgen Technology reserves the right to change the contents of this document without prior notice.

If colors of actual products are different from those mentioned within this manual, please take the actual product as the standard.

Software Version

Version	Date	Note
1.0	2014-06-15	Original release.

Clarification of notation used within this publication.

SIGN	INSTRUCTION
 NOTE	Highlights an essential element of a procedure to ensure correctness.

# CONTENT

1	OVERVIEW .....	5
2	PERFORMANCE AND CHARACTERISTICS .....	6
3	SPECIFICATION .....	8
4	PANEL DESCRIPTION .....	9
5	PANEL BUTTON OPERATION .....	10
5.1	PRIORITY SETTING .....	11
5.2	AC SYSTEM SETTING.....	12
5.3	DELAY ADJUSTMENT .....	13
5.4	RESTORE FACTORY DEFAULT .....	14
6	PROGRAMMED PARAMETER AND RANGE.....	15
7	OPERATION CONTROL .....	17
8	DESCRIPTION OF CONNECTING TERMINALS.....	18
9	TYPICAL WIRING DIAGRAM.....	19
10	INSTALLATION.....	21
11	FAULT FINDING .....	22

Smartgen

## 1 OVERVIEW

The powerful Microprocessor contained within the **HAT520** ATS controller allows for precision voltage (2-way 3-phase/single phase) measuring and make accurate judgment on abnormal voltage (power lost, over/under voltage, over/under frequency, loss of phase, phase sequence wrong) and control ATS to transfer after the delay has expired. This controller is suitable for *NO Breaking ATS*. When 1# power is abnormal, the controller will send signal to start genset after the “1# abnormal delay” has expired. “Three remote” (remote control, remote measurement and remote communication) function can be implemented with the help of LINK communication port.

Smartgen

## 2 PERFORMANCE AND CHARACTERISTICS

**HAT520** ATS controller can monitor 2-way 3-phase 4-wire voltage, 2-phase 3-wire and single-phase 2-wire voltage (2 way mains, or 1 way mains and 1 way generator) and control ATS to transfer. Its performance and characteristics are shown as below,

- Measure and display 2-way 3 phase Voltage and Frequency:

1#	2#
Line voltage (Uab, Ubc, Uca)	Line voltage (Uab, Ubc, Uca)
Phase voltage (Ua, Ub, Uc)	Phase voltage (Ua, Ub, Uc)
Frequency Hz	Frequency Hz

- Over/under voltage, loss of phase, phase sequence wrong, over/under frequency protection function. As default, phase sequence wrong protection and over/under frequency protection are disable; however, users can set the protection function as need.
- Parameters can be set via PC software using SG72 module (USB to LINK) or other converse module.
- The voltage normal delay of 1# or 2#can be set in (0~60) seconds and the Genset start delay can be set in (0~3600) seconds.
- The voltage abnormal delay of 1# or 2#can be set in (0~60) seconds and the Genset stop delay can be set in (0~3600) seconds.
- “1# power priority”, “Auto/Manual”, “No priority” and “2#power priority” can be set via controller front panel.
- Closing output signal can be set as on intervals or as continuous output.
- Applicable for 2 isolated neutral line.
- Auto/Manual mode. In manual mode, ATS transfer can be implemented via panel pushbutton.
- LEDs mounted on front panel can clearly show ATS running status.
- The output contactor capacity of 1# and 2#power supply transfer relay (1#CLOSE, 2#CLOSE) is 16A AC250V, volts-free contact, can be directly used in driving switch to transfer.
- The output contactor capacity of Genset start relay (GENS START) is 7A AC250V/7A DC28V, volts-free N/C contact.
- Suitable for various AC systems (3 phase 4-wires, 2-phase 3-wires and single-phase 2-wire).
- Controller has strong ability of anti-electromagnetic interference, can be used under

complex electromagnetic interference environment.

- ▣ Modular design, self extinguishing ABS plastic shell, pluggable terminal, built-in mounting , compact structure with easy installation.

Smartgen

### 3 SPECIFICATION

Items	Contents
Operating Voltage	AC170V~277V during AC power L1N1/L2N2 supply.
Power Consumption	<2W (Standby mode: <1W)
AC Voltage Input	
3P4W (ph-N)	AC170V~AC277V(ph-N)
1P2W (ph-N)	AC170V~AC277V (ph-N)
2P3W (ph-N)	AC170V~AC277V(ph-N)
Rated Frequency	50/60Hz
1# Close Relay Output	16A AC250V Volts free output
2# Close Relay Output	16A AC250V Volts free output
Gen Start Relay	7A AC250V Volts free output
1# Close Input	COM connect is active.
2# Close Input	COM connect is active.
Communication	LINK interface, MODBUS Protocol
Case Dimensions	139mmx120mmx48mm
Panel Cutout	130mmx111mm
Working Conditions	Temperature: (-25~+70)°C; Humidity: (20~93)%RH
Storage Condition	Temperature: (-25~+70)°C
Protection Level	IP55 Gasket
Insulation Strength	Apply AC2.2kV voltage between high voltage terminal and low voltage terminal; The leakage current is not more than 3mA within 1min.
Weight	0.49kg



## 4 PANEL DESCRIPTION

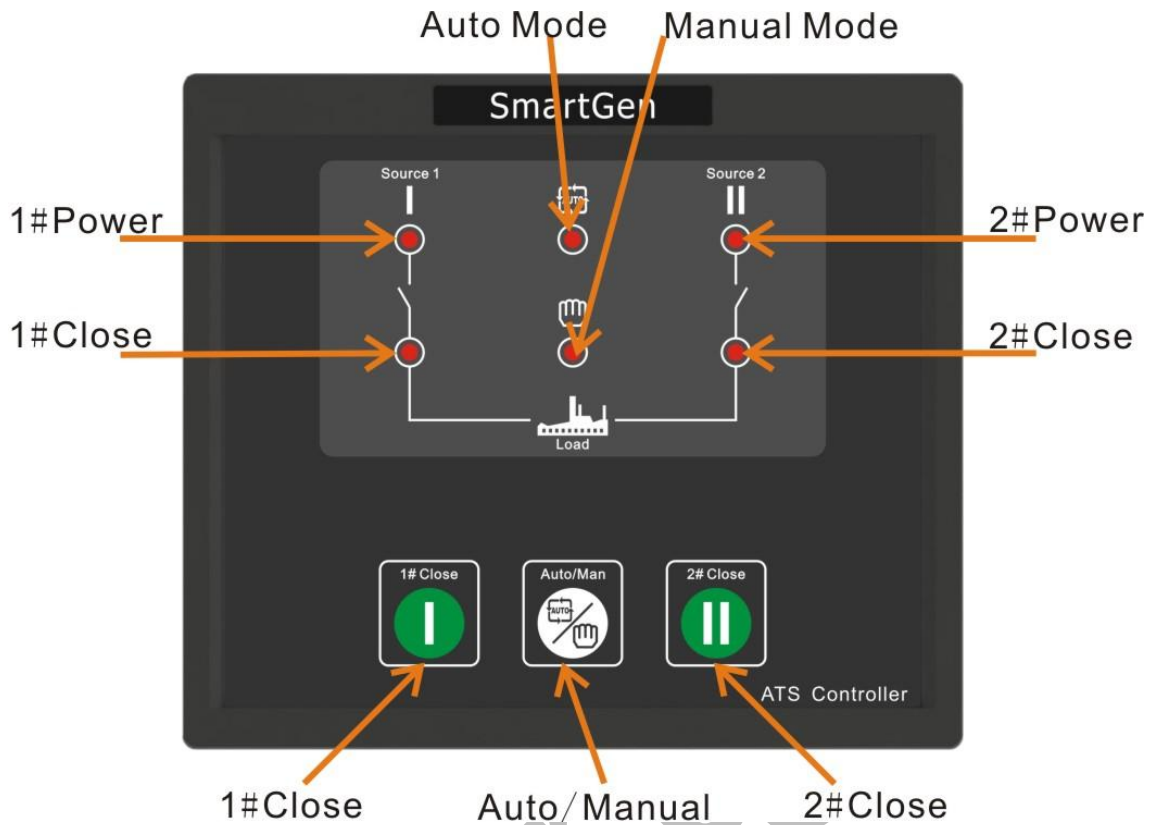

### ▲ NOTE: indicators description:

#### 1. Indicators Description (in test mode):

**1# Power Indicator:** It is illuminated when 1# power is normal; flashing when 1# power state is abnormal; off when there is no 1# power.

**2# Power Indicator:** It is illuminated when 2# power is normal; flashing when 2# power state is abnormal; off when there is no 2# power.

**1# Close Indicator:** It is illuminated when 1# power auxiliary contactor is active while off when it is deactivated.

**2# Close Indicator:** It is illuminated when 2# power auxiliary contactor is active while off when it is deactivated.



**Auto Mode Indicator:** It is illuminated when the controller is in auto mode while off the controller is in manual mode.



**Manual Mode Indicator:** It is illuminated when the controller is in manual mode while off the controller is in auto mode.

#### 2. Indicators Description (When set the parameters)

More details please refer to the following description of "*Panel Button Operation*"

## 5 PANEL BUTTON OPERATION

Pressing and holding the  button for more than 3s, all LEDs are illuminated to enter into lamp test mode; under this mode, the controller will back to normal status automatically after release the  button.





Pressing and holding the  button for more than 7s, all LEDs are flashing (500ms per time) to enter into parameter setting status, users can set the parameters after release the  button. If users don't want to set the parameters under this status: 1) Pressing and holding the  button again until all LEDs are flashing 5 times rapidly (200ms per time) which means the controller enter into normal status; 2) Or the controller will back to normal status automatically about 90s later.

Smartgen

## 5.1 PRIORITY SETTING

Power priority can be set only when the controller is in parameters setting status.

### Procedures of setting “1# power priority”, “2#power priority” and “No priority”:

- 1) Press ,  and  at the same time, when 1#/2#power indicator and auto indicator are illuminated; release the three buttons, then the auto indicator and 2#power indicators extinguish, 1# power indicator illuminates, which means controller priority can be set.
- 2) Pressing  can circularly set 3 priority conditions of power supply.
  - **1# Power Priority:** 1# power indicator illuminates and 2#power indicator extinguishes;
  - **2#Power Priority:** 2#power indicator illuminates and 1# power indicator extinguishes;
  - **No Priority:** 1# power and 2#power indicators are illuminating at the same time;
- 3) After adjusting, press , when 1# power indicator, auto indicator and 2#power indicator are illuminating, the adjusted power priority has been saved. The controller will back to normal status automatically after all LEDs are flashing 5 times rapidly and controller will work according to the priority.







**▲Note:** Once the controller is power on, its priority can be judged by the following three conditions.

- If 1# power supply indicator flashes rapidly for three times, indicating 1# power supply for priority transfer.
- If 2#power supply indicator flashes rapidly for three times, indicating 2#power supply for priority transfer.
- If 1# and 2#power supply indicators flash simultaneously for three times, indicating there is no priority transfer.

## 5.2 AC SYSTEM SETTING

AC system can be set only when the controller is in parameters setting status.

**Procedures of setting “Single-phase 2-wire”, “3-phase 4-wire” and “2-phase 3-wire”:**

- 1) Press ,  and  at the same time, when 1#/2#power indicator and auto indicator are illuminated; release the three buttons, then the auto indicator and 2#power indicators extinguish, 1# power indicator illuminates.
- 2) Press , when 1#/2#power indicator and auto indicator are illuminated; release the button, then the auto indicator and 1#/2#power indicators are extinguished simultaneously, which means controller AC system can be set.
- 3) Pressing  can circularly set three AC systems.
  - **Single-phase 2-wire:** 1# close indicator illuminates;
  - **3-phase 4-wire:** 1# close indicator, 2#close indicator and manual mode indicator illuminates simultaneously;
  - **2-phase 3-wire:** 1# close indicator and manual mode indicator illuminates simultaneously;
- 4) After adjusting, press , when 1# power indicator, auto indicator and 2#power indicator are illuminating, the adjusted AC system has been saved. The controller will back to normal status automatically after all LEDs are flashing 5 times rapidly and controller will work according to the set AC system.

**▲Note:** Once the controller is power on, its AC system can be judged by the following three conditions.



- If 1# close indicator illuminates means **Single-phase 2-wire** system is selected.
- If 1# close indicator, manual mode indicator and 2#close indicator illuminate simultaneously means **3-phase 4-wire** system is selected.
- If 1# close indicator and manual mode indicator illuminate simultaneously means **2-phase 3-wire** system is selected.

### 5.3 DELAY ADJUSTMENT

Delay value can be set only when the controller is in parameters setting status.

- ◆ Adjusting “1# power normal delay” potentiometer (locate nearby the back panel terminal) can set output delay after 1# power supply is normal.
- ◆ Adjusting “2#power normal delay” potentiometer (locate nearby the back panel terminal) can set output delay after 2#power supply is normal.

#### Setting Procedures of “1# power abnormal delay” and “2#power abnormal delay”:



- a) Press  and  at the same time, when 1#/2#power indicator and auto indicator are illuminated; release the two buttons, then the auto indicator and 1#/2#power indicators are extinguished simultaneously which means the delay timer of the controller can be set.
  - 1# power abnormal delay: adjust “1# Power Normal Delay” potentiometer;
  - 2#power abnormal delay: adjust “2#Power Normal Delay” potentiometer;
- b) After adjusting the delays, press . When 1#/2#power indicator and automatic indicator are illuminated simultaneously, the adjusted value has been saved. The controller will back to normal status automatically after all LEDs are flashing 5 times rapidly and controller will work according to the set delay values.

**▲NOTE:** 1# Normal Delay set value must be no less than 1# Abnormal Delay, otherwise, 1# Normal Delay set value will be forced set as 1# Abnormal Delay set value.

The matters need attention of 2# is same as 1#.

## 5.4 RESTORE FACTORY DEFAULT

Default value can be set only when the controller is in parameters setting status.

- a) Press  and  at the same time, when 1#/2#power indicator and auto indicator are illuminated; release the two buttons, then the auto indicator and 1#/2#power indicators are extinguished simultaneously which means the default delay value of the controller can be set.
- b) Press , when 1#/2#power indicator and auto indicator are illuminated simultaneously, the factory default has been restored. The controller will back to normal status automatically after all LEDs are flashing 5 times rapidly and controller will work according to the set delay values.

**▲Note:** By default, 1# and 2#abnormal delay is 5s and genset stop delay is 90s.

Smartgen

## 6 PROGRAMMED PARAMETER AND RANGE

No.	Item	Range	Default	Description
01	1# Normal Delay	(0-60)s	Can be set via controller potentiometer	It is the delay of 1# power from voltage abnormal to voltage normal. Generally, it is 10s.
02	1# Abnormal Delay	(0-60)s	5	It is the delay of 1# power from voltage normal to voltage abnormal.
03	2# Normal Delay	(0-60)s	Can be set via controller potentiometer	It is the delay of 2# power from voltage abnormal to voltage normal. Generally, it is 10s.
04	2# Abnormal Delay	(0-60)s	5	It is the delay of 1# power from voltage normal to voltage abnormal.
05	Close Delay	(0-20)s	5	Closing relay output pulse. If set as zero, it is continuous output.
06	Exceed Transfer	(0-20.0)s	0.0	It is the extra output delay of the close relay after the closing signal has received.
07	Start Delay	(0-3600)s	1	When voltage is abnormal, start delay begins; start signal is initiated after the delay has expired.
08	Stop Delay	(0-3600)s	90	When starting, if the voltage is normal, stop delay begins; stop signal is initiated after the delay has expired.
09	AC System	(0-2)	0	0. 3-phase 4 wires 1. 2-phase 3 wires 2. Single phase 2 wire
10	Rated Volt	(100-240)V	230	AC system rated voltage.
11	Rated Frequency	(50.0-60.0)Hz	50.0	To offer standards for detecting of over/under frequency.
12	Over Volt Enable	(0-1)	1	0: Disable; 1: Enable
13	Over Voltage	(100-120%)	115	Voltage upper limit; it is abnormal when the voltage has exceed the set value.
14	Over Voltage Return	(100-120%)	113	Voltage upper limit return value; it is normal only when the voltage fallen below the set value.
15	Under voltage	(70-100%)	75	Voltage lower limit; it is abnormal when the voltage has fallen below the set value.
16	Under Voltage Return	(70-100%)	77	Voltage lower limit return value; it is normal only when the voltage has exceeded the set value.
17	Over Freq Enable	(0-1)	0	0: Disable; 1: Enable

No.	Item	Range	Default	Description
18	Over Frequency	(100-120%)	110	Frequency upper limit; it is abnormal when the frequency has exceed the set value.
19	Over Frequency Return	(100-120%)	104	Frequency upper limit return value; it is normal only when the frequency fallen below the set value.
20	Under Freq Enable	(0-1)	0	0: Disable; 1: Enable
21	Under Frequency	(80-100%)	90	Frequency lower limit; it is abnormal when the frequency has fallen below the set value.
22	Under Frequency Return	(80-100%)	96	Frequency lower limit return value; it is normal only when the frequency has exceeded the set value.
23	Loss of Phase	(0-1)	1	0: Disable; 1: Enable
24	Phase Sequence Wrong	(0-1)	0	0: Disable; 1: Enable
25	Priority Select	(0-2)	0	0. 1# Priority; 1. 2# Priority; 2. NO Priority

**▲NOTE:**

“1# Normal Delay” and “2# Normal Delay” can be set only via the potentiometer which locate nearby the back panel terminal.

“1# Abnormal Delay” and “2# Abnormal Delay” can be set via the PC software or potentiometer which locate nearby the back panel terminal.

AC system and priority selection can be set via panel button or PC software while other parameters can be set via PC software only.



1# Normal Delay set value must be no less than 1# Abnormal Delay, otherwise, 1# Normal Delay set value will be forced set as 1# Abnormal Delay set value. The matters need attention of 2# is same as 1#.

If motor driving type ATS (e.g. SOCOMEC VS) is applied, the Close delay and Open delay must be no less than 5s; If magnet driving type ATS (e.g. SGQ-N) is applied, the Exceed Transfer delay must be set as 0.



## 7 OPERATION CONTROL

### Auto/Manual Operation:

When controller is running, pressing  key can set the controller as Auto mode or Manual mode (indicate by automatic and manual indicators). In Manual mode, press  key, load will be transferred to 1# power supply; press  key, load will be transferred to 2#power supply.

Smartgen

## 8 DESCRIPTION OF CONNECTING TERMINALS

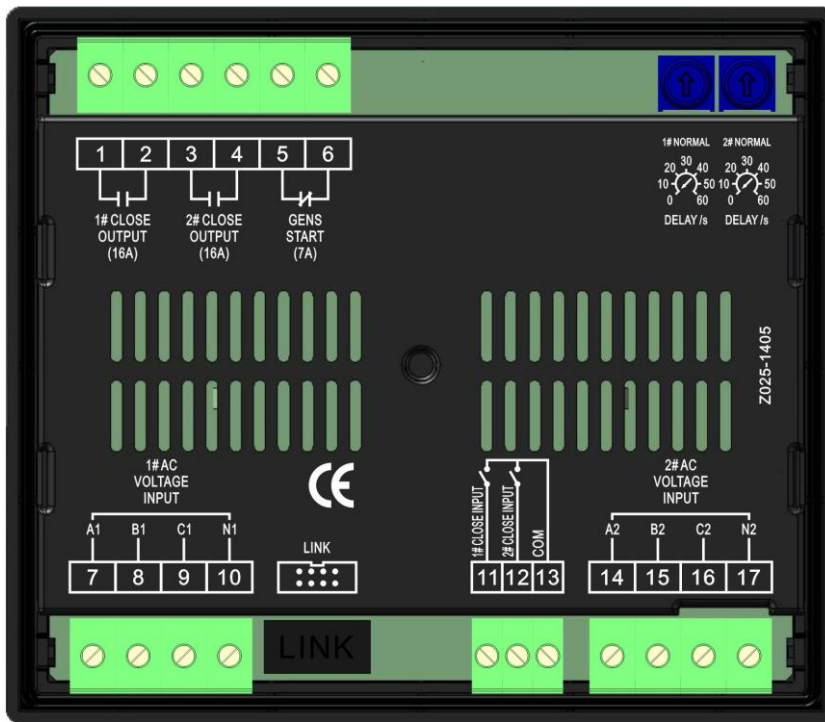

Terminal Description:

NO.	Items	Description	Remark
1	1# Close Output	Volt-free relay contact output	N/O contact output; rated 16A.
2			
3	2# Close Output	Volt-free relay contact output	N/O contact output; rated 16A.
4			
5	Gens Start	Volt-free relay contact output	N/O contact output; rated 7A.
6			
7	A1	1# AC 3-phase 4 wire voltage input	For single phase, only connect A1, N1.
8	B1		
9	C1		
10	N1		
11	1# Close Input	Detection of 1# ATS closing status; auxiliary contact input	Connect COM is active.
12	2# Close Input	Detection of 2# ATS closing status; auxiliary contact input	Connect COM is active.
13	COM	COM	
14	A2	2# AC 3-phase 4 wire voltage input	For single phase, only connect A2, N2.
15	B2		
16	C2		
17	N2		
LINK	Communication Port	Communicate with PC/Program update	

## 9 TYPICAL WIRING DIAGRAM

SGQ-N/T Wiring Diagram

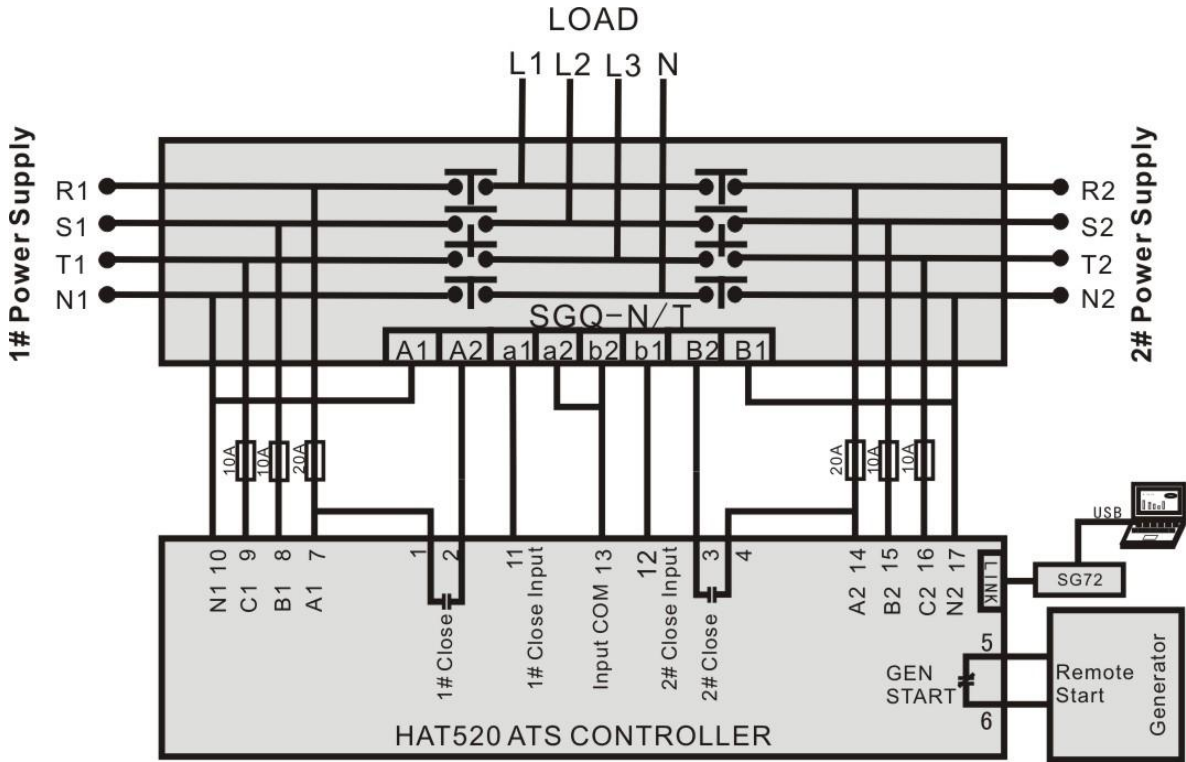

SGQ-M Wiring Diagram

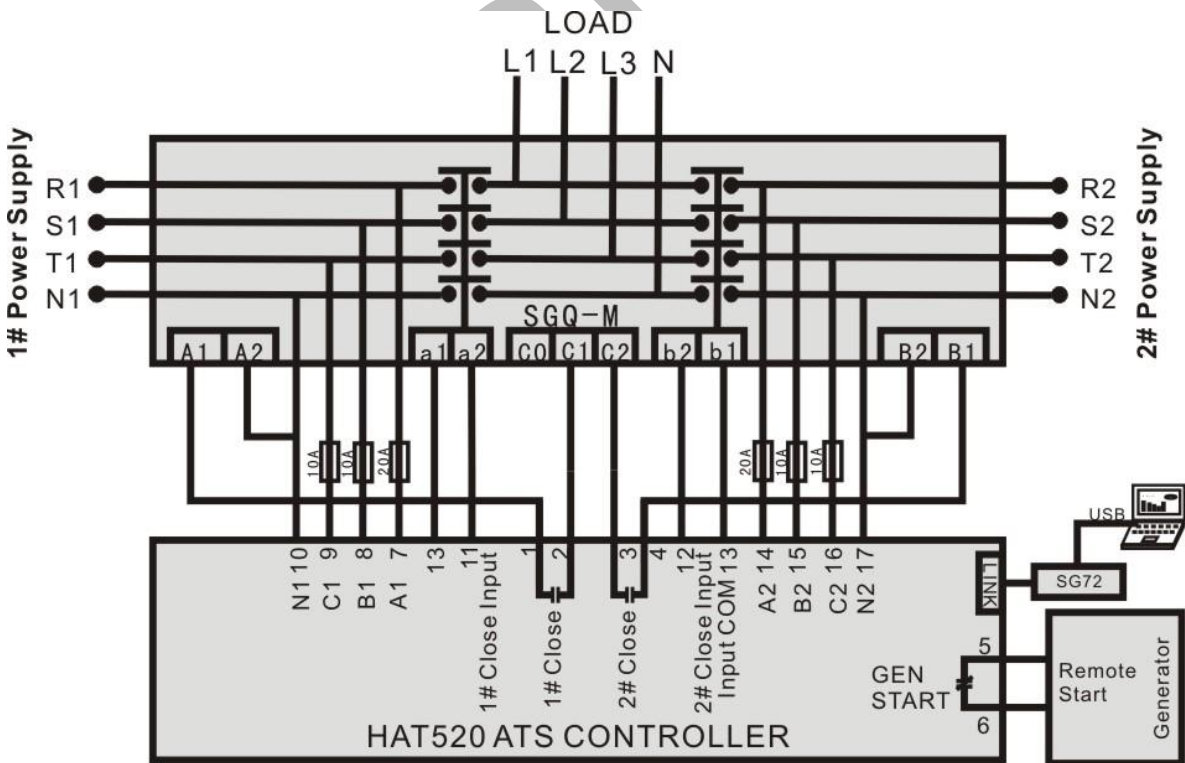

▲ Note : The diagram is for reference only. The actual wiring shall follow the ATS instruction. Users should choose proper fuse capacity according to the actual power consumption.

2-phase 3-wire Wiring Diagram

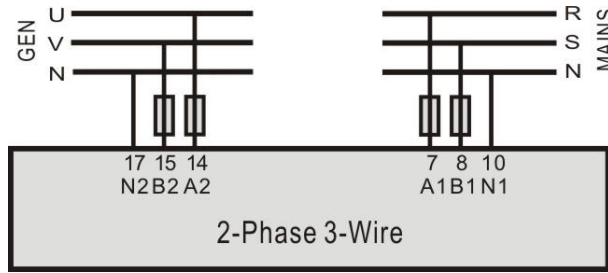

Single phase 2-wire Wiring Diagram

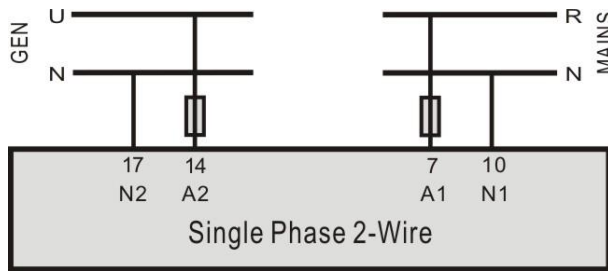

**NOTE:** Above pictures take the AC 220V voltage as example. If AC 110V voltage is applied in actual use, please contact with Smartgen technical staff to get the specific wiring methods.

Smartgen

## 10 INSTALLATION

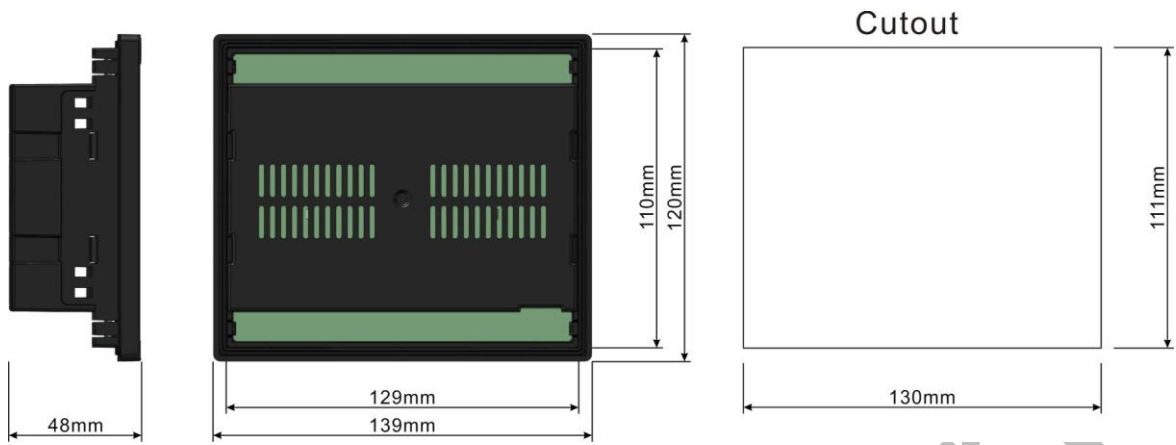

Smartger

**11 FAULT FINDING**

Symptom	Possible Solutions
Controller no response with power.	Check starting batteries.
Genset running while ATS not transfer	Check ATS; Check the connection wirings between the controller and the ATS.
Electrical parameters detection error	Check controller wiring; Modify electrical parameters detection value
PC software communication failure	Check communication port setting and connections.

Smartgen