



SmartGen
ideas for power

HSM340

SYNCHRONOUS MODULE

USER MANUAL

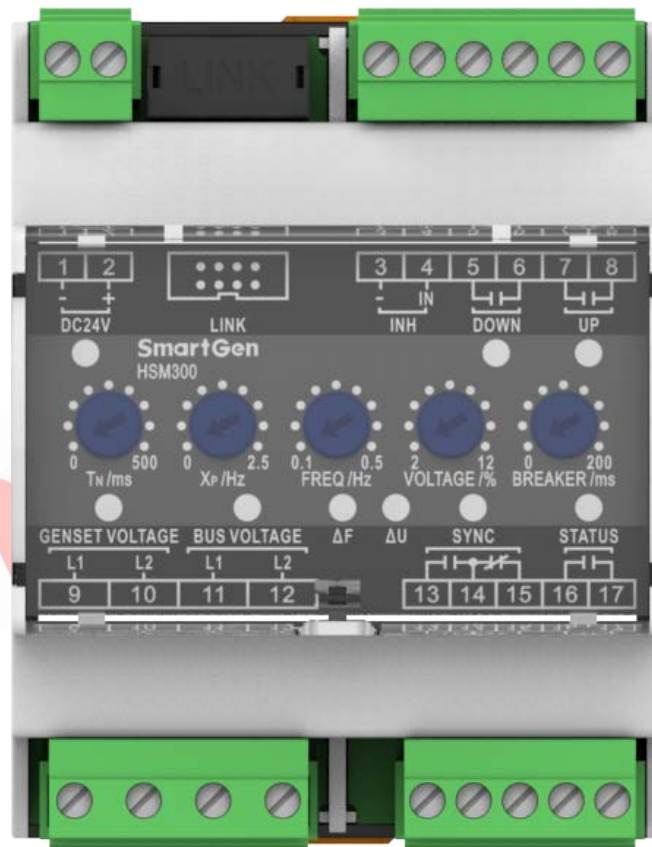

SMARTGEN (ZHENGZHOU) TECHNOLOGY CO., LTD.



Chinese trademark

SmartGen English trademark

SmartGen — make your generator *smart*

SmartGen Technology Co., Ltd.

No.28 Jinsuo Road

Zhengzhou City

Henan Province

P. R. China

Tel: +86-371-67988888/67981888/67992951

+86-371-67981000(overseas)

Fax: +86-371-67992952

Email: sales@smartgen.cn

Web: www.smartgen.com.cn / www.smartgen.cn

All rights reserved. No part of this publication may be reproduced in any material form (including photocopying or storing in any medium by electronic means or other) without the written permission of the copyright holder.

Applications for the copyright holder's written permission to reproduce any part of this publication should be addressed to SmartGen Technology at the address above.



Any reference to trademarked product names used within this publication is owned by their respective companies.

SmartGen Technology reserves the right to change the contents of this document without prior notice.

Table 1 - Software Version

Date	Version	Content
2019-06-03	1.0	Original release.
2020-12-07	1.1	Modify the cover product picture, wire diameter and other descriptions.

Table 2 - Symbol Description

Symbol	Description
 NOTE	Highlights an essential element of a procedure to ensure correctness.
 CAUTION!	Indicates a procedure or practice, which, if not strictly observed, could result in damage or destruction of equipment.

SmartGen

CONTENT

1	OVERVIEW.....	5
2	PERFORMANCE AND CHARACTERISTICS	5
3	SPECIFICATION.....	6
4	PANEL INDICATORS AND TERMINALS DESCRIPTION	7
5	SCOPES AND DEFINITIONS OF PROGRAMMABLE PARAMETERS	9
6	FUNCTION DESCRIPTION.....	10
7	RAISE/DROP SPEED RELAY OUTPUT CONTROL	11
8	TYPICAL DIAGRAM	12
9	CASE DIMENSION.....	12
10	INSTALLATION NOTES	13
	10.1 OUTPUT AND EXPAND RELAYS	13
	10.2 WITHSTAND VOLTAGE TEST	13

SmartGen

1 OVERVIEW

HSM340 Synchronous Module is specially designed for automatic parallel of 400Hz system genset. According to the pre-set parameters, the module can automatically complete genset parallel condition detection (volt difference, frequency difference and phase) and send parallel signal when the conditions are well prepared.

HSM340 Synchronous Module applies to the occasion where it can synchronize generator to the bus. The module is simple to operate, easy to install and widely used on ship genset and land genset.

2 PERFORMANCE AND CHARACTERISTICS

Main characteristics are as below:

- Suitable for 3-phase 4-wire, 3-phase 3-wire, 2-phase 3-wire, single phase 2-wire power system with 400Hz frequency;
- Adjustable potentiometer allowing to set the main parameters about synchronization;
- Operating parameters can be set via PC test software. LINK port should be connected to computer via SG72 module (USB to LINK);
- 4 relay outputs, 2 of which are used for speed UP output and DOWN output; 1 SYNC relay is used for sync close output, and 1 STATUS relay is used for status output after close;
- 1 INH “inhibit sync close output” digital input; when it is active and gens synchronizes with bus, the SYNC indicator will illuminate and sync close relay is inhibited to output;
- Wide power supply range DC(8~35)V;
- 35mm guide rail mounting;
- Modular design, pluggable terminal, compact structure with easy installation.

3 SPECIFICATION

Table 3 - Product Parameters

Items	Contents
Working Voltage	DC8.0V to 35.0V, continuous power supply.
Overall Consumption	≤1W(Standby mode≤0.5W)
AC Voltage Input	AC50V~ AC620 V (ph-ph)
AC Frequency	400Hz
SYNC Output	7A AC250V Volts free output
UP Output	5A AC250V/5A DC30V Volts free output
DOWN Output	5A AC250V/5A DC30V Volts free output
STATUS Output	5A AC250V/5A DC30V Volts free output
Case Dimensions	71.6mm x 89.7mm x 60.7mm
Working Conditions	Temperature: (-25~+70)°C Relative Humidity: (20~95)%
Storage Conditions	Temperature: (-30~+80)°C
Insulation Intensity	Apply AC2.2kV voltage between high voltage terminal and low voltage terminal; The leakage current is not more than 3mA within 1min.
Weight	0.20kg

4 PANEL INDICATORS AND TERMINALS DESCRIPTION

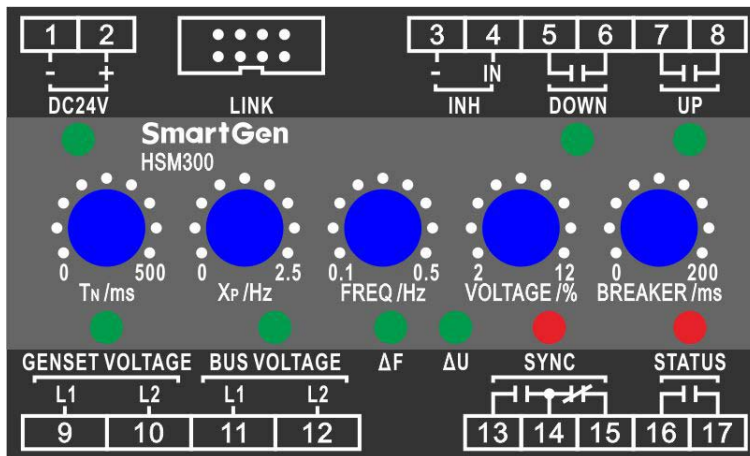

Fig.1 - Mask Drawing

Table 4 - LEDs Definition Description

Indicators	Color	Description	Notes
DC 24V	Green	Power indicator, it illuminates when power works well.	
UP	Green	It illuminates when raising speed pulse is sent.	
DOWN	Green	It illuminates when decreasing speed pulse is sent.	
GENSET	Green	It always illuminates when gens voltage and frequency are normal; it flashes when gens voltage and frequency are abnormal; it is extinguished when there is no power.	
BUS	Green	It always illuminates when bus voltage and frequency are normal; it flashes when bus voltage and frequency are abnormal; it is extinguished when there is no power.	
ΔF Freq Diff.	Green	It illuminates when gens' and bus' frequency and voltage are normal, and real-time difference is in the pre-set range.	
ΔU Volt Diff.	Green	It illuminates when gens' and bus' frequency and voltage are normal, and real-time voltage difference is in the pre-set range.	
SYNC Close	Red	When close relay outputs, the lamp will illuminate. Close pulse: 400ms.	
STATUS	Red	After close signal outputs, the relay outputs and it illuminates; when synchronization between gens and bus isn't detected, the relay will not output and the lamp will extinguish.	

Table 5 - Potentiometer Description

Potentiometer	Range	Description	Note
T _N /ms Length of Control Pulse	(25-500)ms	Min. lasting time of control pulse.	
X _P /Hz Proportion Range	(0-±2.5)Hz	In this area, pulse width is in direct proportion to deviation value of rated frequency.	X _P /Hz proportion range
FREQ/Hz	(0.1-0.5)Hz	Acceptable frequency difference.	
VOLTAGE/%	(2-12)%	Acceptable voltage difference	
BREAKER/ms	(20-200)ms	The time of switch close.	

Table 6 - Terminal Connection Description

No.	Function	Cable Size	Note	
1.	DC Power Input -	1.5mm ²	Connected with negative of starter battery.	
2.	DC Power Input +	1.5mm ²	Connected with positive of starter battery.	
3.	INH	-	“Close Output Inhibit” Input	
4.		IN		
5.	DOWN Output	1.0mm ²	Output when speed reduces.	Normally open; Volts free output; 5A Rated
6.				
7.	UP Output	1.0mm ²	Output when speed raises.	Normally open; Volts free output; 5A Rated
8.				
9.	GEN L1 Phase Input	1.0mm ²	Gen AC voltage input.	
10.	GEN L2 Phase Input			
11.	BUS L1 Phase Input	1.0mm ²	Bus AC voltage input.	
12.	BUS L2 Phase Input			
13.	SYNC	N/O	Output when SYNC closes.	Relay normally open, normally close contacts; Volts free output; 7A Rated
14.		COM		
15.		N/C		
16.	STATUS	1.0mm ²	Close status output	Normally open contact, Volts free; 5A Rated
17.		1.0mm ²		
LINK	Used for parameters setting or software upgrade.			



Fig.2 - PC Programming Connection

▲NOTE: PC programming connection: make LINK port of SG72 module of our company connect with LINK port of the module, and do parameter setting and real time monitoring by PC software of our company. Please see Fig. 2.

5 SCOPES AND DEFINITIONS OF PROGRAMMABLE PARAMETERS

Table 7 - Module Configurable Parameters

No.	Items	Range	Defaults	Description
1.	Gens AC System	(0-3)	0	0: 3P3W, 1: 1P2W, 2: 3P4W, 3: 2P3W
2.	Gens Rated Voltage	(30-30000) V	400	
3.	Gens PT Fitted	(0-1)	0	0: Disabled 1: Enabled
4.	Gens PT Primary Volt.	(30-30000)V	100	
5.	Gens PT Secondary Volt.	(30-1000)V	100	
6.	Gens Over Volt. Set	(0-1)	1	0: Disabled 1: Enabled
7.		(100-120) %	115	Threshold
8.		(100-120) %	113	Return Value
9.		(0-3600) s	3	Delay Value
10.	Gens Under Volt. Set	(0-1)	1	0: Disabled 1: Enabled
11.		(70-100) %	82	Threshold
12.		(70-100) %	84	Return Value
13.		(0-3600) s	3	Delay Value
14.	Gens Over Freq. Set	(0-1)	1	0: Disabled 1: Enabled
15.		(100-120) %	110	Threshold
16.		(100-120) %	104	Return Value
17.		(0-3600) s	3	Delay Value
18.	Gens Under Freq. Set	(0-1)	1	0: Disabled 1: Enabled
19.		(80-100) %	90	Threshold
20.		(80-100) %	96	Return Value
21.		(0-3600) s	3	Delay Value

No.	Items	Range	Defaults	Description
22.	Bus AC System	(0-3)	0	0: 3P3W, 1: 1P2W, 2: 3P4W, 3: 2P3W
23.	Bus Rated Voltage	(30-30000) V	400	
24.	Bus PT Fitted	(0-1)	0	0: Disabled 1: Enabled
25.	Bus PT Primary Volt.	(30-30000)V	100	
26.	Bus PT Secondary Volt.	(30-1000)V	100	
27.	Bus Over Volt. Set	(0-1)	1	0: Disabled 1: Enabled
28.		(100-120) %	115	Threshold
29.		(100-120) %	113	Return Value
30.		(0-3600) s	3	Delay Value
31.	Bus Under Volt. Set	(0-1)	1	0: Disabled 1: Enabled
32.		(70-100) %	82	Threshold
33.		(70-100) %	84	Return Value
34.		(0-3600) s	3	Delay Value
35.	Bus Over Freq. Set	(0-1)	1	0: Disabled 1: Enabled
36.		(100-120) %	110	Threshold
37.		(100-120) %	104	Return Value
38.		(0-3600) s	3	Delay Value
39.	Bus Under Freq. Set	(0-1)	1	0: Disabled 1: Enabled
40.		(80-100) %	90	Threshold
41.		(80-100) %	96	Return Value
42.		(0-3600) s	3	Delay Value
43.	Module Address	(1-254)	1	
44.	T _P	(1-20)	10	Speed regulation pulse period=T _P xT _N

6 FUNCTION DESCRIPTION

HSM340 Synchronous Module is to synchronize generator to bus. When voltage difference, frequency difference and phase difference are within pre-set value, it will send synchronization signal to close gens switch. Because switch close response time can be set, the module can be used for gensets of various source powers.

Users can set over voltage, under voltage, over frequency and under frequency thresholds of gens and bus via PC monitoring software. When the module detects voltage and frequency of gens and bus are normal, it will begin to adjust speed. When voltage difference, frequency difference and phase difference are within pre-set value, it will send synchronization signal to close gens switch.

7 RAISE/DROP SPEED RELAY OUTPUT CONTROL

When deviation area X_P is set as 2Hz, the working principle of raise/drop speed relay is as follows.

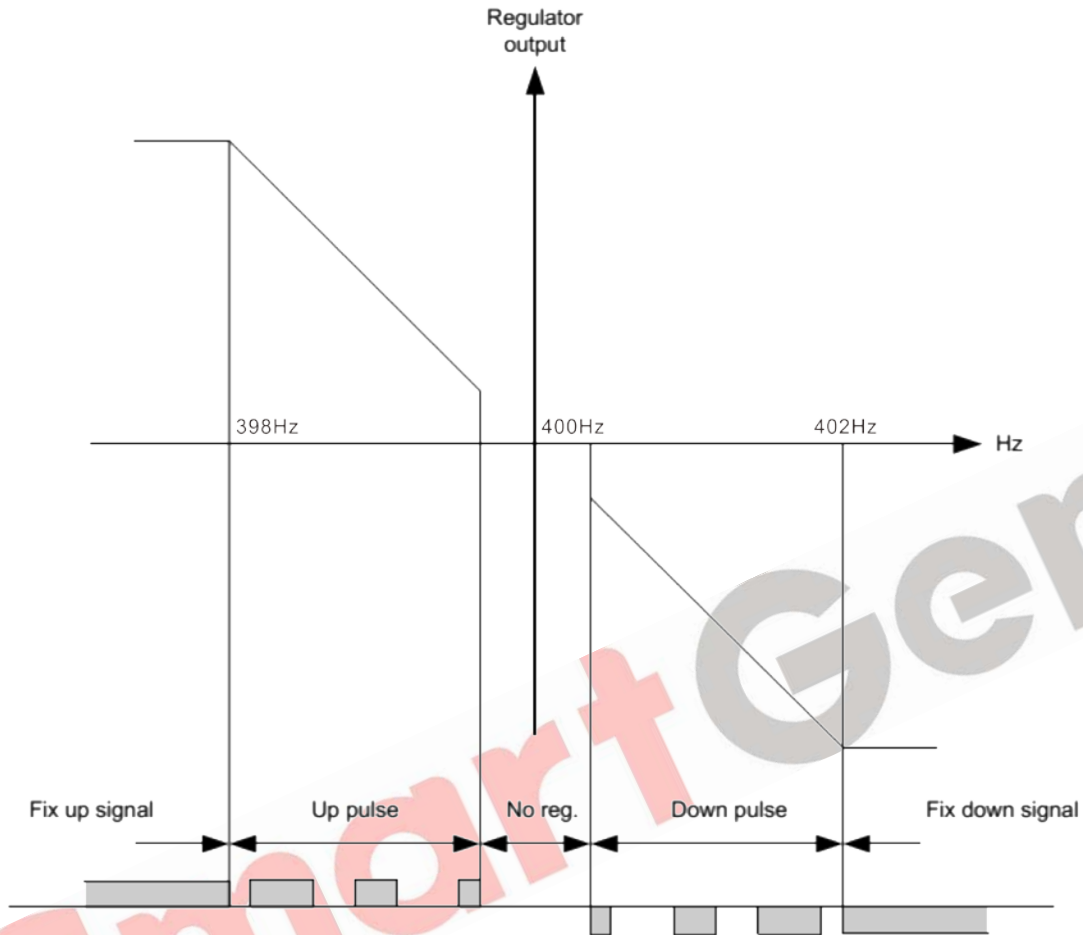

Fig.3 - Working Principle of Raise/Drop Speed Relay

Relay output regulation function can be divided into 5 steps.

Table 8 - Term Description

No.	Range	Description	Note
1	Fix Up Signal	Continuous raise signal	Adjusting activation. For too large derivation, relay has to activate continuously.
2	Up Pulse	Raise the pulse	System adjusting activation. Relay works in pulse to eliminate derivation.
3	No Reg.	No regulation	No regulation in this area.
4	Down Pulse	Drop down the pulse	System adjusting activation. Relay works in pulse to extinguish derivation.
5	Fix Down Signal	Continuous drop signal	System adjusting activation. For too large derivation, drop relay will remain in activating status.

As Fig.3 shows, when adjusting deviation X_P exceeds pre-set value, the relay will be in continuous

activating status; when X_p is not large, the relay will work in pulse. In Up Pulse, much smaller the derivation is, much shorter the pulse becomes. When regulator output value is close to “No Reg.”, pulse width will be the shortest value; when regulator output value is nearest to the “Down Pulse”, pulse width will be the longest value.

8 TYPICAL DIAGRAM

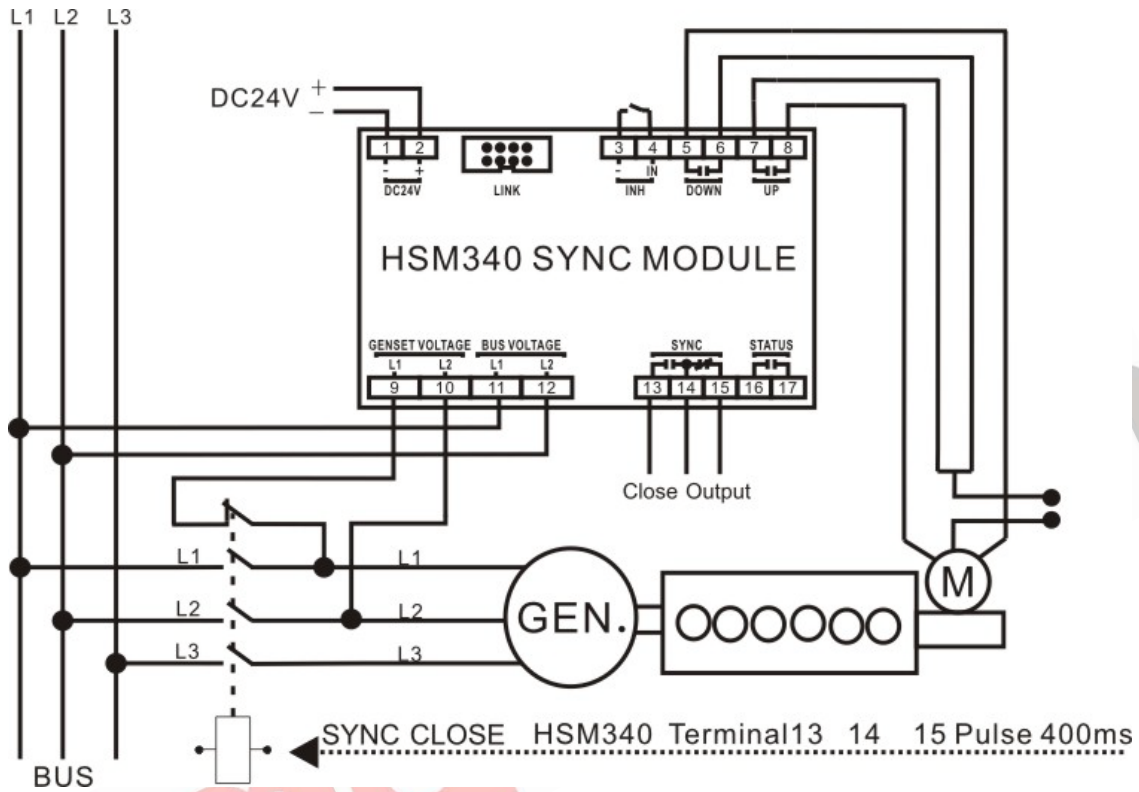

Fig. 4 - HSM340 3Phase 3Wire Typical Application

9 CASE DIMENSION

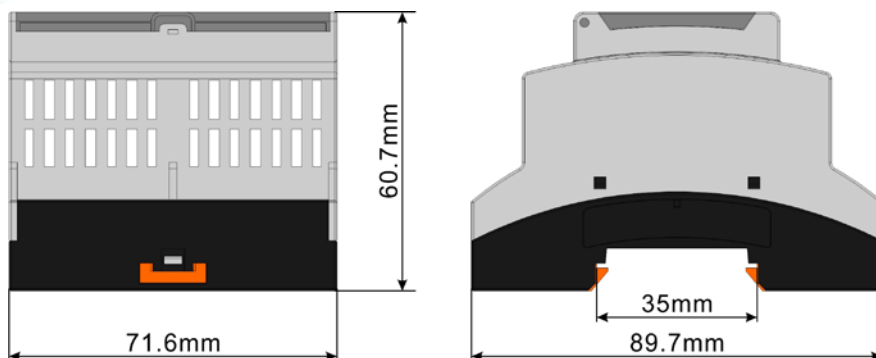

Fig.5 - Overall Dimensions

10 INSTALLATION NOTES

10.1 OUTPUT AND EXPAND RELAYS

All outputs are relay contact outputs. If it needs to expand relay, please add freewheel diode to both ends of expand relay's coils (when coils of relay has DC current), or add resistance-capacitance loop (when coils of relay has AC current), in order to prevent disturbance for controller or other equipments.

10.2 WITHSTAND VOLTAGE TEST

▲CAUTION! When controller has been installed on control panel, if it needs to do high voltage test, please disconnect relay's all terminal connections, for the purpose of preventing high voltage entering relay and damaging it.

SmartGen