

SmartGen

MAKING CONTROL SMARTER

HWP30N/HWP40N FORCED CIRCULATION HEATER USER MANUAL

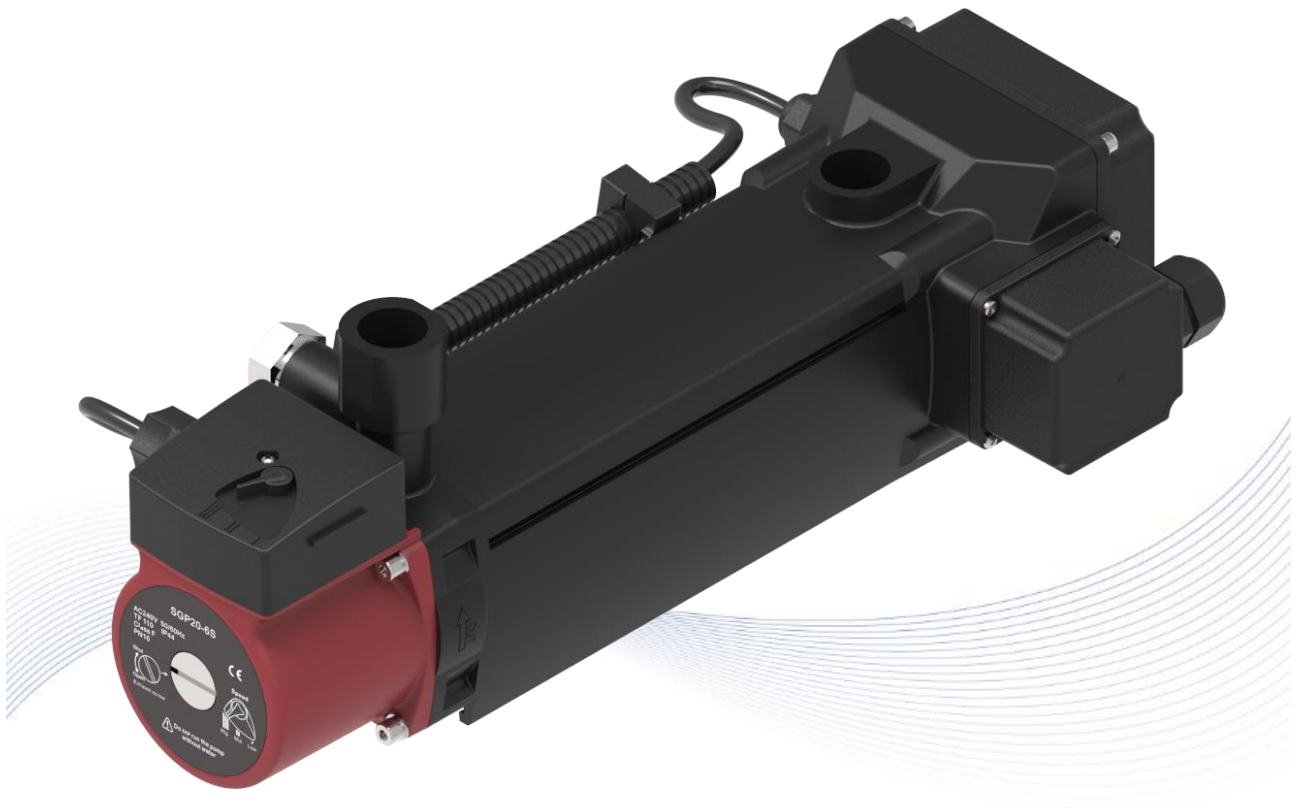

郑州众智科技股份有限公司
SMARTGEN(ZHENGZHOU)TECHNOLOGY CO.,LTD.

All rights reserved. No part of this publication may be reproduced in any material form (including photocopying or storing in any medium by electronic means or other) without the written permission of the copyright holder.

SmartGen reserves the right to change the contents of this document without prior notice.

Table 1 Software Version

Date	Version	Note
2019-09-07	1.0	Original release.
2020-08-07	1.1	Modify the product appearance figure.
2020-12-11	1.2	1. Add the power on manual and auto modes, save the work mode before power off; add the indicator introductions of temperature, voltage, running time and power consumption; optimize the words and punctuations; 2. Modify the product weight.
2021-01-26	1.3	1. Add the model HWP30N; 2. Modify the figure of pagoda header.
2021-04-26	1.4	1. Change the water drain valve; 2. Change the water drain valve drawing.
2021-09-16	1.5	Optimize the figures of Installation Logic Diagram, Installation Side Schematic and Overall Dimensions.
2022-08-05	1.6	Change wiring way, cover picture, installation logic diagram, installation position diagram, operation panel diagram, wiring diagram, case dimensions, add maintenance description.
2023-02-22	1.7	Delete the inappropriate translation of "Performance and Characteristics"; Modify the information of foreword.
2023-09-09	1.8	1. Add the description of working voltage range; 2. Modify the alarm threshold values of over/under voltage; 3. Add accessory number for packing list.

CONTENT

1. OVERVIEW.....	4
2. PERFORMANCE AND CHARACTERISTICS.....	4
3. SPECIFICATION	5
4. HEATER INSTALLATION	6
5. OPERATING INSTRUCTIONS	8
5.1 BUTTON DESCRIPTION	8
5.2 INDICATOR DESCRIPTION	8
5.3 DISPLAY ILLUSTRATION	9
5.4 FAULT CODE.....	9
5.5 OPERATION PANEL	10
5.6 OPERATION DESCRIPTION	10
5.6.1 PARAMETER CHECK.....	10
5.6.2 COMMISSIONING	10
5.6.3 PARAMETER SETTING.....	10
6. USE AND MAINTENANCE	11
7. CASE DIMENSIONS	13
8. PACKING LIST.....	13

SmartGen

1. OVERVIEW

HWP30N/HWP40N is smart forced circulation water heater of engine. When engine operation temperature is below 4°C, engine liquid coolant/lubricating oil may be coagulated to solid state in starting phase and lose lubrication or cooling effects, so that it may damage the engine. Therefore, heater shall be installed for engine to ensure normal starting and running.

It has lamp indication function, which can indicate all kinds of heater statuses. Heating temperature can be set by users, and dry burning prevention and overheating protection are fitted.

This product is suitable for various engines with (15~30)L displacement.

Please login our company's official website (www.smartgen.cn) to select heaters.

2. PERFORMANCE AND CHARACTERISTICS

- Micro-processor design is applied for the control part, precise temperature sampling, heating temperature can be set from control panel.
- 4-bit digital tube display is applied, which can display current coolant temperature, user defined temperature, accumulated running time, accumulated energy consumption, current voltage parameters etc.
- Circulation pump and heater are controlled separately; water pump is firstly started before heating, and then heater starts after delay for 5s; when it reaches pre-set temperature point, heater power is disconnected immediately; then water pump power is cut off after delay for 60s; this is to prevent heat gathering so that it can prolong pump life.
- Manual test function is fitted, which can check whether heating body and water pump is able to operate normally through panel button.
- Fine cast aluminum material is used for heater shell.
- Stainless steel inner heating pipes.
- Water drain valve is fitted at the bottom of the heater, which can be used on demand.
- This product can work normally at -40°C temperature.

3. SPECIFICATION

Table 2 Performance Parameter

Type	HWP30N	HWP40N
Rated Power	3000W	4000W
Rated Voltage	AC 240V	
Rated Current	12.5A	16.7A
Working Voltage Range	AC (168~264)V	
Phase	Single phase	
Engine Displacement	13~20L	20~30L
Thermostat Range	Off: (5~70)°C On: (0~65)°C	
Default Thermostat Range	Off: (40±2)°C On: (25±2)°C	
Overheating Thermostat Range	Off: (95±3)°C On: Manual	
Insulating Resistance	≥50MΩ	
Electrical Strength	AC 1.5kV 1min	
Inlet/Outlet Size	G 3/4 Internal thread (Selectable Φ19.5mm Pagoda header or G 3/4 External thread)	
Max. Water Pressure	0.5MPa	
Pump Flow Velocity	40L/min (1.5m of lift)	
Protection Level	IP44	
Vibration Resistance	(5~8)Hz Amplitude±7.5mm Triaxial (8~500)Hz a=2g Triaxial	
Shock Resistance	Half-sine Wave; a _{peak} =50g; Triaxial	
Working Temperature	-40°C~+70°C	
Storage Temperature	-40°C~+80°C	
Case Dimensions	414mm×175mm×116mm	
Weight (include accessories)	5.3kg	

4. HEATER INSTALLATION

Please install the heater vertically according to the diagram before use. Pay attention to the direction of heater inlet and outlet, and ensure that the heater position is below the lowest water level of the engine and that all the air is exhausted out of the heater. Perfuse the heater with coolant.

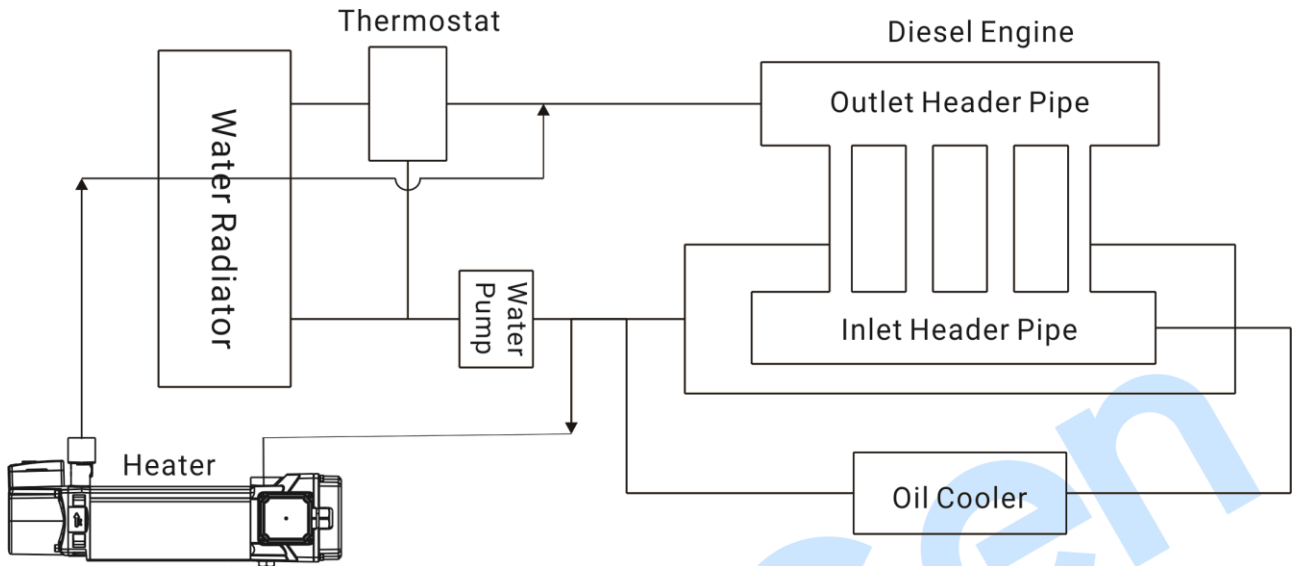

Fig.1 Installation Logic Diagram

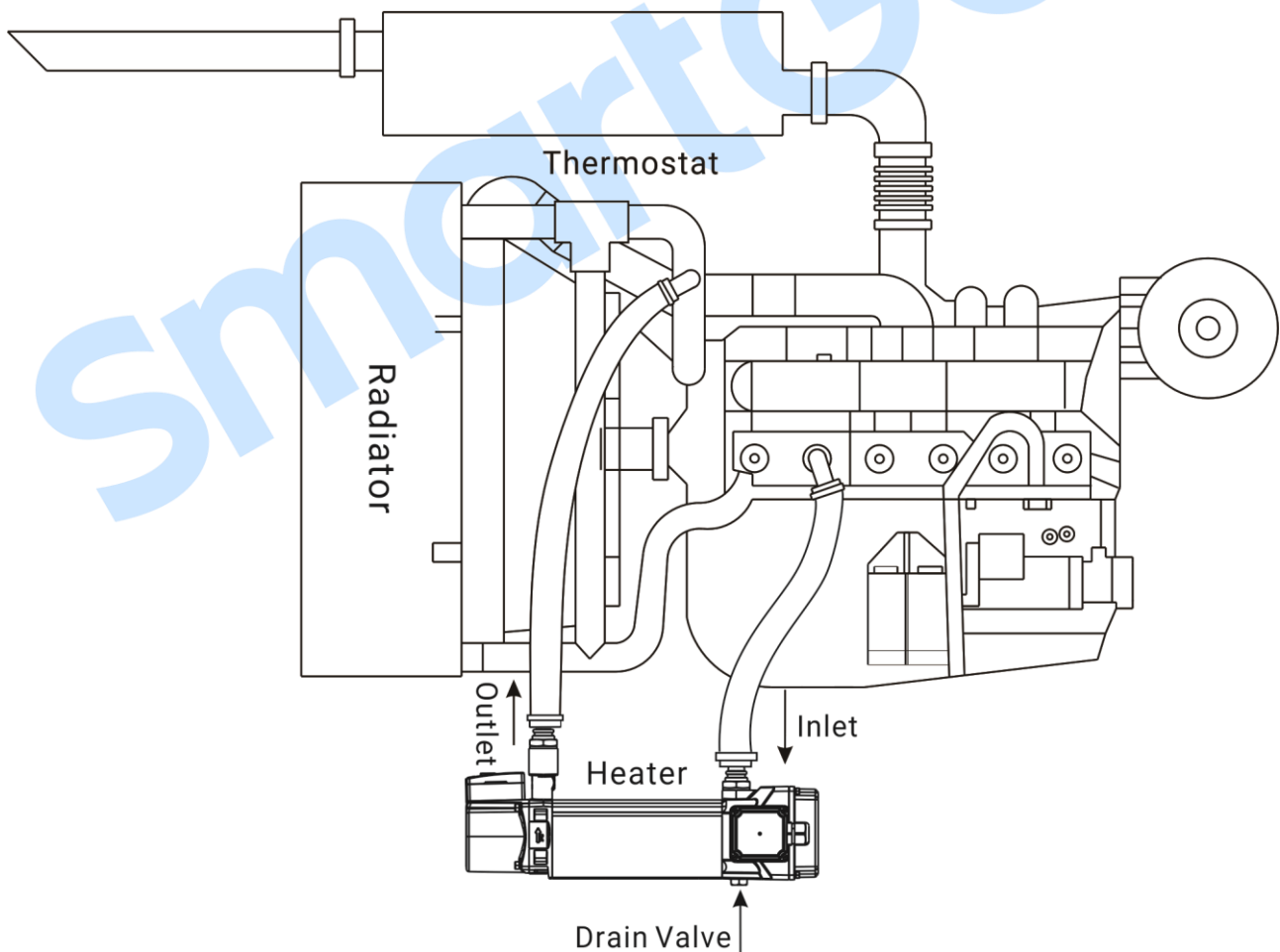

Fig.2 Installation Position Diagram

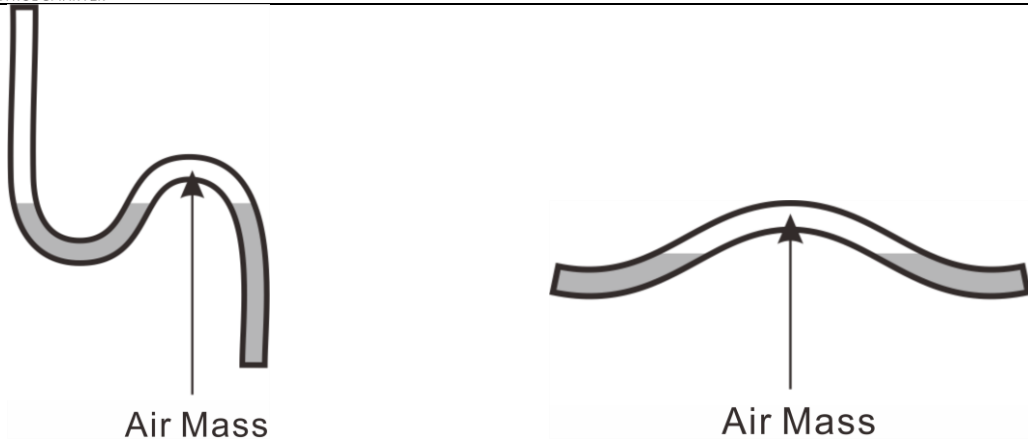

Fig.3 Incorrect Pipe Connection Methods





NOTE: If there is a W-shaped bend or reverse U-shaped bend during pipe connection, the air accumulated in the pipe cannot be discharged normally, resulting in the liquid cannot be circulated properly. The air dissolved in the liquid will be precipitated during heating and retained in the bend, so on the condition of unsmoothed pipeline, even if by the manual exhaust, it will repeat in the next heating process of air collection. To ensure that the smooth liquid circulation, the hosepipe with an inner diameter of more than 20mm and pipe joints with an inner diameter of more than 15mm should be selected.

SmartGen

5. OPERATING INSTRUCTIONS

5.1 BUTTON DESCRIPTION

Table 3 Button Descriptions

Button	Definition	Description
	Heating	Press and if coolant temperature is below the set cut-off temperature, heater will transfer to auto status; If coolant temperature is above the set cut-off temperature, heater works for 15s and enters auto status after commissioning.
	Stop	Press and heater will stop.
	Set	Press and enter parameter setting menu.
	Up	Display the last digital cube content and do value adjustment.
	Down	Display the next digital cube content and do value adjustment.









5.2 INDICATOR DESCRIPTION

Table 4 Indicator Description

Sign	Definition	Description
Alarm	Alarm indicator	When lamp is illuminated, heater fault occurs and please decide fault type according to the fault code of digital cube.
Auto/Heat	Auto/Heating	Heater is in auto state when it is flashing; it is in heating state when the lamp is always illuminated.
Stop	Stop indicator	Heater is in stop state when lamp is illuminated.
°C	Temp. indicator	They are used to indicate the type of value displayed on main interface; after entering the password on display interface, press the up button or down button, the running time indicator or power consumption indicator is illuminated; when on the parameter value interface, the calibration serial number interface, the software version interface and the enter password interface, the four indicators flash 0.5s once.
V	Volt. Indicator	
10xHour	Running time indicator	
10xkWh	Power consumption indicator	

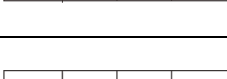



5.3 DISPLAY ILLUSTRATION

Table 5 Display Illustration

Sign	Definition	Description
	Cut-off Temperature	The set value of target temperature.
	Reset Temperature	The set value of reset temperature.
	Current Voltage Value	It is current power voltage when V indicator is light on.
	Accumulated Running Time	It is total running time when 10×Hour indicator is light on; unit is hour, detailed hours are the displayed number x10; e.g. displayed number is 1234, and the actual hours are 12340.
	Accumulated Energy Consumption	It is total energy consumption when 10×kWh indicator is light on; unit is kWh; detailed kWh is the displayed number x10; e.g. displayed number is 456.7, and the actual kWh is 4567.
	Dry Burning Temperature Sensor Enable	00: Disable; 01: Enable.
	Voltage Protection Enable	00: Disable; 01: Enable.
	Start Mode	00: Power on manual start mode; 01: Power on auto start mode; 02: Keep the work mode before power off.

5.4 FAULT CODE

Table 6 Fault Code

Sign	Definition	Description
	Fault Code 1	Dry burning/water shortage protection.
	Fault Code 2	Water temperature sensor open circuit.
	Fault Code 3	Dry burning temperature sensor open circuit.
	Over Voltage	If set the voltage protection as “Disable”, when input voltage is higher than 264V, the heater will only warn but not stop operating; if set as “Enable”, the heater will stop operating and enter into standby status. When voltage is less than 252V, the warning of over voltage is removed.
	Under Voltage	If set the voltage protection as “Disable”, when input voltage is less than 168V, the heater will only warn but not stop; if set as “Enable”, the heater will stop

Sign	Definition	Description
		operating and enter into standby status. When voltage is higher than 180V, the warning of under voltage is removed.

5.5 OPERATION PANEL

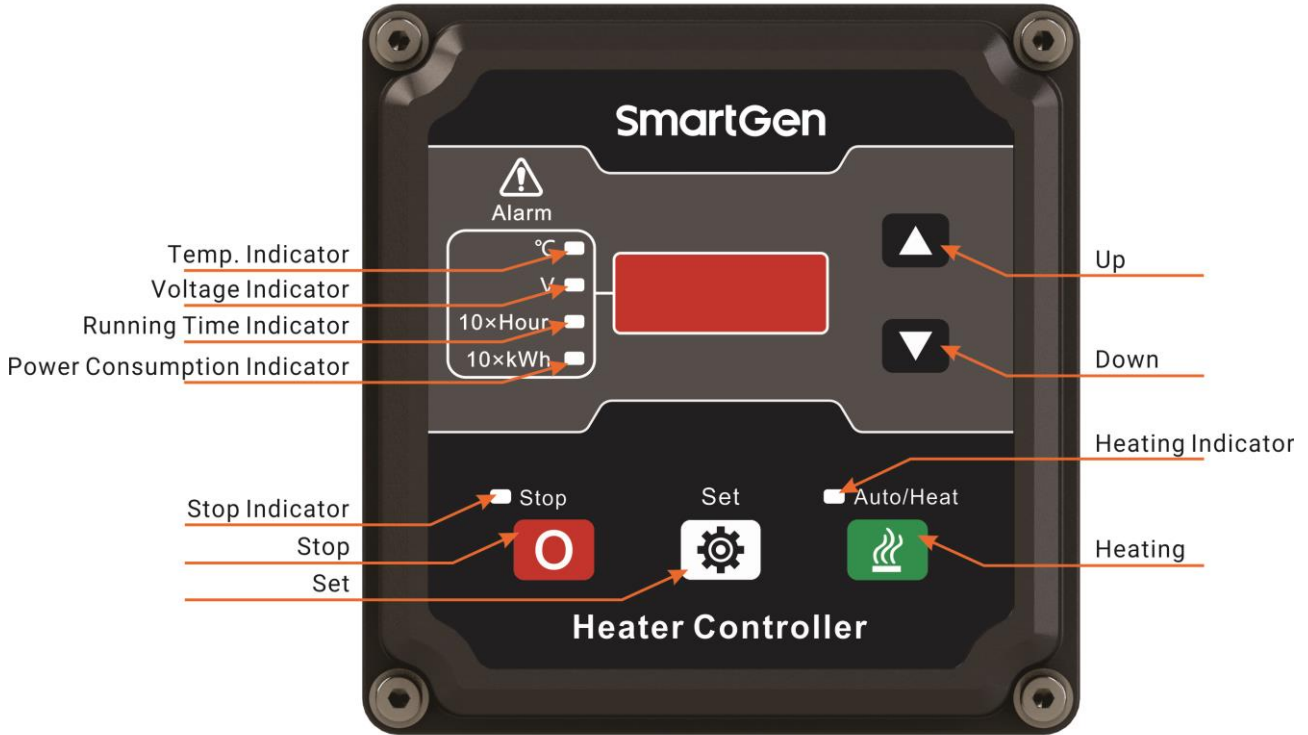

Fig.4 Operation Panel Drawing

5.6 OPERATION DESCRIPTION

5.6.1 PARAMETER CHECK

Press and to switchover digital cube display and do value adjustment.

5.6.2 COMMISSIONING

If water temperature is above pre-set reset temperature, press and heater will enter commissioning status, and it will transfer to auto status after heating for 10s.

5.6.3 PARAMETER SETTING

Press and enter parameter setting menu, and it will display (H means the set temperature is cut-off temperature value, 40°C is only an example). Press again to enter the setting, and adjust values by and . Press again to move or confirm. Press and it will go back to the main menu. It will also return back to first page if there is no operation within 1 minute.

6. USE AND MAINTENANCE

- 1) After it is connected with power, heater is at stop state. Press Auto/Heat and make heater enter working status.
- 2) When it needs to be checked/fixed or change pipe or some part, press Stop and make heater enter stop status.
- 3) Before start please confirm whether heater is fully filled with coolant and make gas in the pipe exhausted by vent valve.
- 4) It is strongly suggested to use antifreeze with corresponding mark number.
- 5) If ordinary water is used, users must drain the water after stop when environment temperature is below 0°C, in order to prevent the water in the heater getting frozen and resulting in heater fracture.
- 6) GND wire must be earth connected.
- 7) Drain valve: Can be opened or closed using hexagonal wrench, adjustable wrench, or a cross screwdriver.



Fig.5 Vent Valve Indicating Diagram

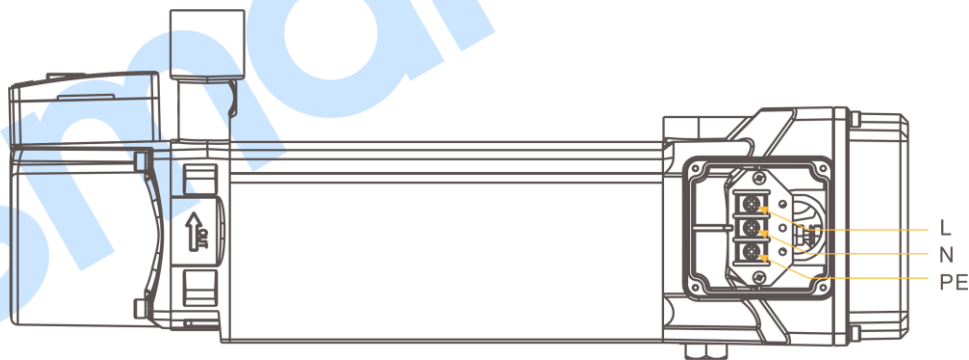

Fig.6 Wire Connection

(Unit: mm)

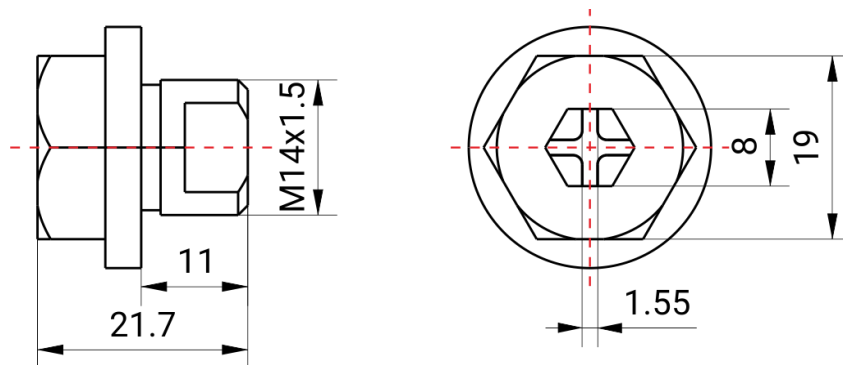

Fig.7 Vent Valve Size

Common Faults and Solutions:**1. Overheat protection:**

- a. Check the valve to assure whether it is opened and whether the heater is full of water;
- b. Check whether the hosepipe has an obvious W-shaped or reverse U-shaped trend, and whether there is an obvious hot and cold alternating area.

Solutions: Shorten the hosepipe length and optimize the hosepipe trend.

2. High water outlet temperature: It occurs when the hosepipe is too long, both the inner diameter of the hosepipe and the inner diameter of the fitting joints are too small, as well as the water flow is not smooth so that the heat cannot be transferred properly.

Solutions: Shorten the hosepipe length, using the hose with an inner diameter of more than 20mm, and the connectors with an inner diameter of more than 15mm.

3. Cannot reach the preheating temperature:

- a. The heater power is not enough;
- b. The cable of the power supply is too long and result in dividing resistance of the cable.

Solutions:

1. Replace the heater whose power matches the engine;
2. Shorten the power cable as possible and increase the cable diameter.

SmartGen

7. CASE DIMENSIONS

Unit: mm

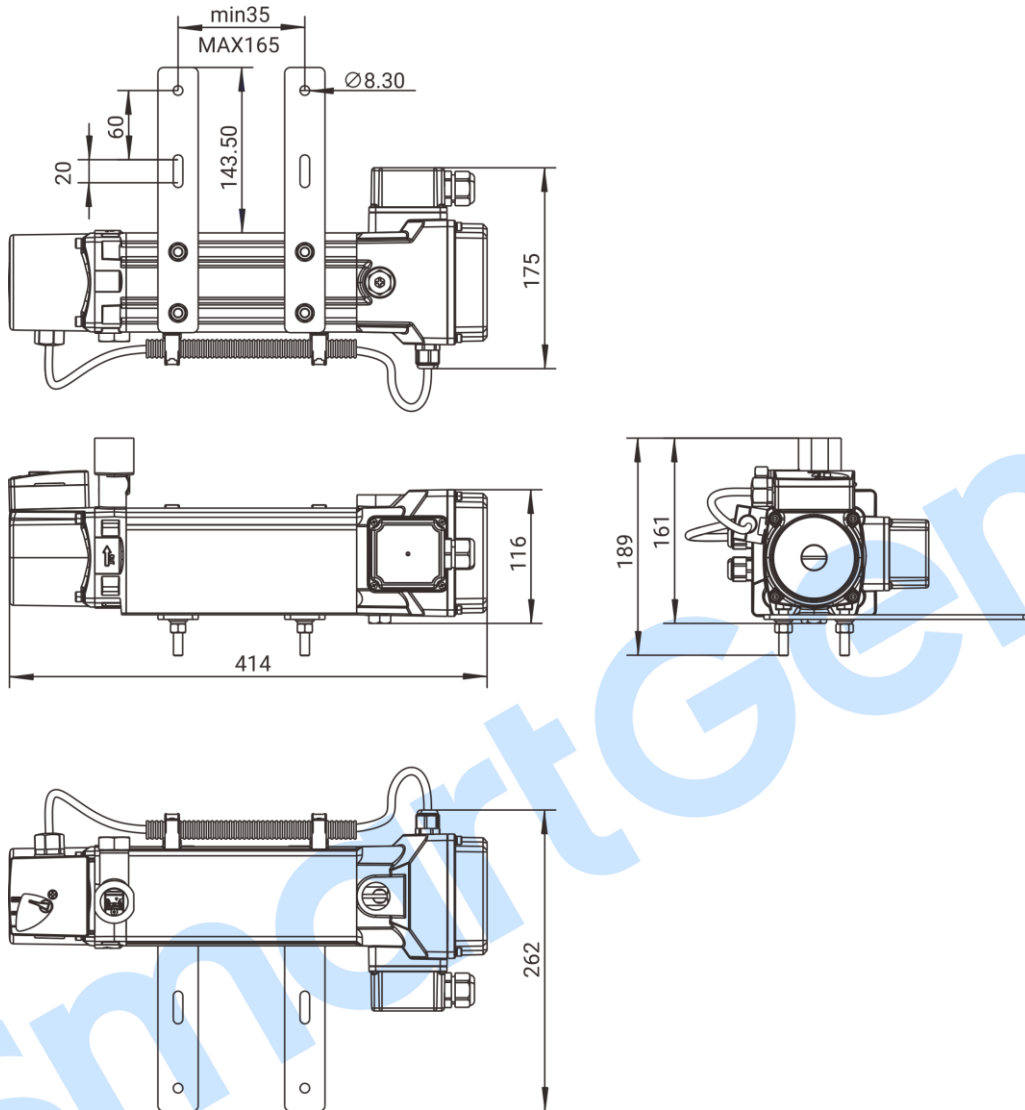

Fig.8 Case Dimensions

NOTE: All the inlets/outlet connectors are internal thread G 3/4.

8. PACKING LIST

Table 7 Packing List

No.	Name	Model	Number for one unit
1	Product	HWP30N/HWP40N	1
2	Stand	ZJ-HWP40N	2
3	Flat Gasket	GB/T 95 8	8
4	Spring Washer	GB/T 93 8	8
5	Hexagon Nut	GB/T 41 M8	8
6	Hexagon Slot	GB/T 5783 M8×40	8
7	Installation Instructions		1

Table 8 Water Gate Accessories

No.	Name	Model	Number for one unit
1	Φ19.5mm Pagoda Joint	BTJT-G3/4-Φ19.5	2
2	G 3/4 Stainless Steel Nipple	DU-G3/4-SS	2
3	ED Sealing Gasket	ED-23.9x29.2x1.5	2

(Unit: mm)

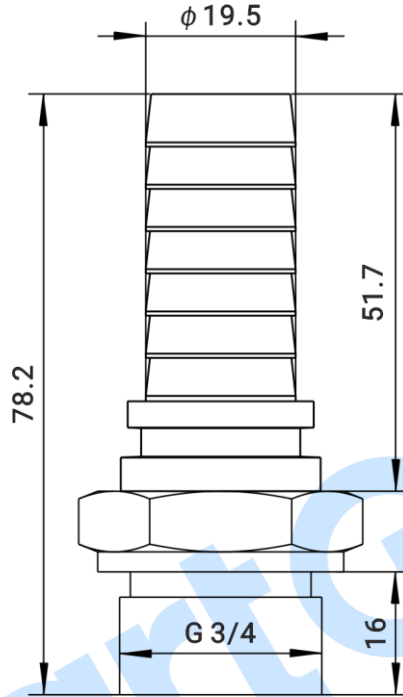

Fig.9 Pagoda Joint Size

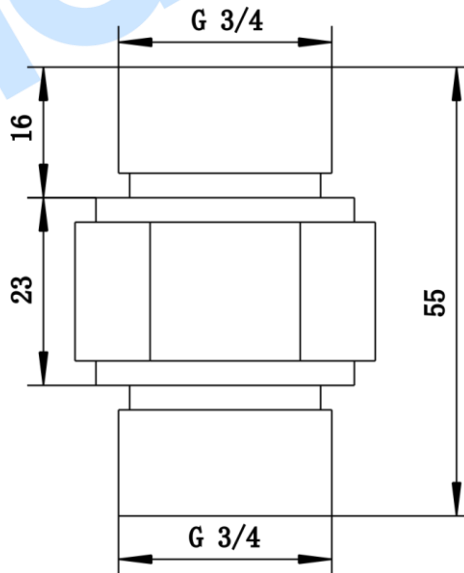

Fig.10 Nipple Size