



SmartGen
ideas for power

MGC120
PETROL GENSET CONTROLLER
USER MANUAL



SMARTGEN (ZHENGZHOU) TECHNOLOGY CO., LTD.



Chinese trademark

SmartGen English trademark

SmartGen — make your generator *smart*

SmartGen Technology Co., Ltd.

No.28 Jinsuo Road

Zhengzhou

Henan Province

P. R. China

Tel: 0086-371-67988888/67981888

0086-371-67991553/67992951

0086-371-67981000(overseas)

Fax: 0086-371-67992952

Web: www.smartgen.com.cn

www.smartgen.cn

Email: sales@smartgen.cn

All rights reserved. No part of this publication may be reproduced in any material form (including photocopying or storing in any medium by electronic means or other) without the written permission of the copyright holder.

Applications for the copyright holder's written permission to reproduce any part of this publication should be addressed to SmartGen Technology at the address above.

Any reference to trademarked product names used within this publication is owned by their respective companies.

SmartGen Technology reserves the right to change the contents of this document without prior notice.

Version History

| Date | Version | Content |
|------------|---------|-------------------|
| 2017-11-07 | 1.0 | Original release. |
| | | |

CONTENT

| | |
|--|----|
| 1 OVERVIEW | 4 |
| 2 PERFORMANCE AND CHARACTERS | 4 |
| 3 SPECIFICATION | 5 |
| 4 OPERATION..... | 6 |
| 4.1 CONTROL PANEL..... | 6 |
| 4.2 INDICATOR DESCRIPTION | 6 |
| 4.3 PUSH BUTTONS..... | 7 |
| 4.4 AUTO START/STOP OPERATION..... | 7 |
| 4.5 MANUAL START/STOP OPERATION | 8 |
| 4.6 AIR FLAP CONTROL | 8 |
| 4.7 ATS SWITCHING CONTROL..... | 8 |
| 5 PROTECTION | 9 |
| 6 CONNECTION | 9 |
| 7 DEFINITION AND RANGE OF PARAMETERS..... | 11 |
| 7.1 PARAMETER SETTINGS | 11 |
| 7.2 PROGRAMMABLE OUTPUTS CONTENT DEFINITION..... | 14 |
| 7.3 PROGRAMMABLE INPUTS CONTENT DEFINITION | 14 |
| 8 CONTROLLER FUNCTION SETTINGS..... | 15 |
| 9 COMMISSIONING | 16 |
| 10 TYPICAL APPLICATION | 16 |
| 11 INSTALLATION..... | 18 |
| 11.1 FIXING CLIPS..... | 18 |
| 11.2 OVERALL AND CUTOUT DIMENSIONS..... | 18 |
| 12 FAULT FINDING..... | 19 |

1 OVERVIEW

MGC120 Petrol Genset Controller belongs to AMF module, which is suit for single petrol genset automation and monitoring control. According to data measuring, it allows auto start/stop genset, alarm protection and ATS switching control functions. The controller fits with LED nixie tube display and button-press operation. Most parameters can be adjusted from the front pannel of controller and all parameters can be changed from PC software via LINK port. It is can be widely used in various petrol genset with easy operation, reliable work, compact structure and easy mounting.

2 PERFORMANCE AND CHARACTERS

- Collecting single phase voltage of mains and generator, which suit for 50Hz/60Hz AC system.
- Switchable displayed parameters:
 - Mains voltage (V)
 - Generator voltage (V)
 - Engine cylinder temperature (°C)
 - Generator frequency (Hz)
 - Battery voltage (V)
 - Accumulated running time(H)
- With mains electricity monitoring and AMF functions;
- Protection function for generator under/over volt, under/over frequency, low oil pressure, and fail to start protection functions; when in protection, LED indicates alarm, and goes shutdown protection;
- Using stepper motor and programmable outputs to control air flap (close/open air flap according to the cylinder temperature);
- Speed signals derive from ignition coil primary (diode need to be in series);
- Three crank disconnect conditions can be optional (generator frequency, speed, and speed + gen frequency);
- 2 discrete inputs, which default set as remote start input and low oil pressure input;
- 3 fixed relay outputs (fuel output, start output and ignition control);
- 2 programmable transistor outputs, which can be set as common alarm output, ETS control, idle control , preheat control, close GCB output, close MCB output and air flap blocked output;
- LINK communication port (SmartGen specialized SG72 adapter): via LINK port to realize controller parameter settings, remote monitoring control and firmware upgrade functions.
- Nixie tube and LED display with button-press operation;
- Silicone panel and buttons with a premium performance to working in the extremely high/low temperature;
- Screen protection adopt hard screen acrylic material;
- Modular design, anti-flaming ABS plastic enclosure, embedded installation way; compact structure with easy mounting;

3 SPECIFICATION

| Items | Contents |
|--|---|
| Working Voltage | DC12V power supply system |
| Overall Consumption | Regular working:<2W(stepper motor is excluded) Standby mode:<0.5W |
| AC Volt Input: Mains Single Phase Generator Single Phase | AC 30V - AC 360V (ph-N) AC 30V - AC 360V (ph-N) |
| Alternator Frequency | 50Hz/60Hz |
| Starter Relay Output | 10A DC30V DC B+ supply output |
| Fuel Relay Output | 10A DC30V DC B+ supply output |
| Ignition Relay Output | 10A DC30V DC B- supply output |
| Flexible Transistor Output | 1A connect to DC B+ supply output |
| Stepper Motor Recommended | 24BYJ48-12V(stepper angle 5.625° reduction ratio 16:1) |
| Overall Dimensions | 95mm x 86mm x 46.5mm |
| Panel Cutout | 78mm x 66mm |
| Working Condition | Temperature:(-25~+70)°C Humidity:(20~93)%RH |
| Storage Condition | Temperature:(-25~+70)°C |
| Protection Level | Front panel IP55 |
| Insulation | Apply AC2.2kV voltage between high voltage terminal and low voltage terminal; The leakage current is not more than 3mA within 1min. |
| Weight | 0.15kg |

4 OPERATION



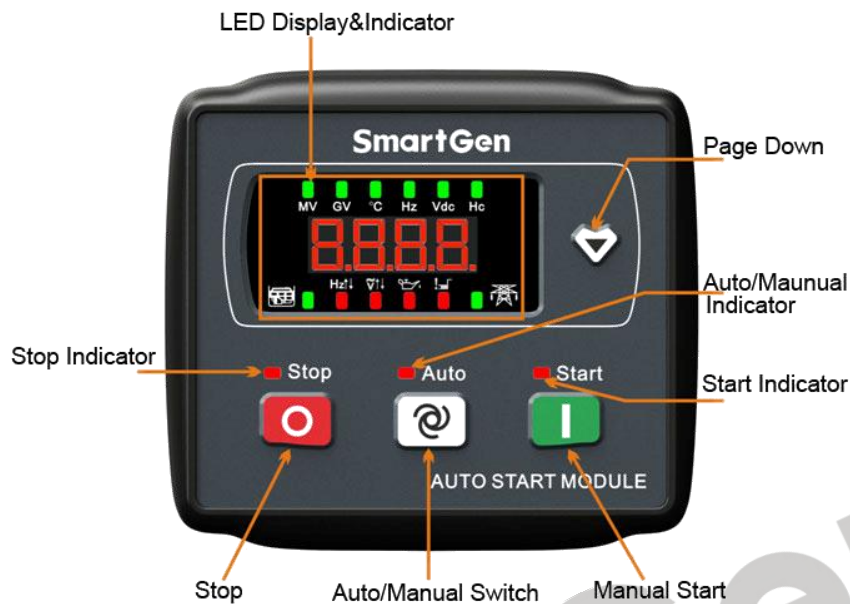









4.1 CONTROL PANEL



Start indicator: it is always light from genset start to normal running, and in other status, the indicator will extinguish.

Stop indicator: it is blink when genset enter into stop sequence; always light when stop and in other status, the indicator will extinguish.

4.2 INDICATOR DESCRIPTION





| Icon | Defination | Icon | Defination |
|---|--|---|---|
|  | Mains voltage indication |  | Generator under/over frequency alarm shutdown |
|  | Generator voltage indication |  | Generator under/over voltage alarm shutdown |
|  | Engine cylinder temperature indication |  | Low oil pressure alarm shutdown |
|  | Generator frequency indication |  | Fail to start |
|  | Battery voltage indication |  | Generator indication |
|  | Total running time indication |  | Mains indication |

Note:

- 1) **Generator indicator:** light-on when generator is normal running; blink when generator is abnormal; light-off when generator is unavailable.
- 2) **Mains indicator:** light-on when mains is normal; blink when mains is abnormal; light-off when mains is unavailable.

4.3 PUSH BUTTONS

Buttons Description

| Icons | Function | Description |
|---|---------------------------------------|---|
|  | Stop/Reset | <p>Stop the running genset both in manual mode and in auto mode, and simultaneously controller switches to the manual mode.</p> <p>In stop process, re-press this button to stop generator immediately.</p> <p>In alarm status, press this button to reset any shutdown alarms.</p> <p>In stop mode, press this button for more than 3s to test if the nixie tube and panel LED indicators are OK.</p> <p>In setting menu, press this button to exit this menu.</p> |
|  | Auto/Manual Switch Increased value | <p>Press this key, if auto indicator lights on, controller states in auto mode; if auto indicator lights off, controller states in manual mode.</p> <p>In setting menu, press this key to downturn or increase the parameter value</p> |
|  | Start Decreased value | <p>In manual mode, press this key to start genset.</p> <p>In setting menu, press this key to upturn or decrease the parameter value</p> |
|  | Down | <p>Switch display contents of nixie tube.</p> <p>Pressing this button for more than 3 seconds to entry the parameter setting menu;</p> <p>In setting menu, press this button to modify and save value.</p> |

4.4 AUTO START/STOP OPERATION

After pressing  key, indicator besides this key lights on, which stands for generator-set states in auto mode.

Auto Start Sequence

- 1) When remote start signal is active or mains failure(over/under voltage) delay is expired, "Start Delay" timer is initiated;
- 2) When start delay is over, preheat relay energizes (if configured), "Preheat delay" is initiated;
- 3) After the above delay, the Fuel Relay is energized, and then one second later (if configured), the Start Relay is engaged and the Preheat Relay switch off. If genset fails to fire during this cranking attempt then the fuel relay and start relay are disengaged for the pre-set rest period; "crank rest time" begins and wait for the next crank attempt.
- 4) Should this start sequence continue beyond the set number of attempts, the fail to start indicator will be illuminated.
- 5) In case of successful crank attempt, the "Safety On" timer is activated, allowing Low Oil Pressure Input is inhibited. As soon as this delay is over, "start idle" delay is initiated (if configured).
- 6) During "start idle" delay, under frequency and under volt alarms are inhibited. When this delay is over, "warming up" delay is initiated (if configured).
- 7) After the "warming up" delay, genset will enter into Normal Running status. If genset voltage or frequency is abnormal, corresponding alarms will be initiated.

Auto Stop Sequence



- 1) When remote start signal is invalid or mains normal delay is expired, "Stop Delay" timer is initiated;
- 2) Once this "stop delay" has expired, the "Cooling Down Delay" is then initiated;
- 3) During "Stop Idle" Delay (if configured), idle relay is energized.
- 4) "ETS Solenoid Hold" begins, ignition control relay is energized while fuel relay is de-energized, and then genset entry standby status.

Note:

- 1) Press stop key in auto start status, generator-set will stop and enter into manual mode simultaneously.
- 2) Total running timer initiate when generator meet crank disconnected conditions, meanwhile, the last decimal point of the nixie tube flashes to indicate that the generator is running.

4.5 MANUAL START/STOP OPERATION

After pressing  key, indicator besides this key lights off, which stands for generator-set states in manual mode.

- a) **Manual start:** press  button to start genset (Please refer to Start Sequence 2-7). With low oil pressure and voltage abnormal during genset running, controller can protect it to stop quickly.
- b) **Manual Stop:** Press  button to stop the running genset (Please refer to Stop Sequence 2-4).

4.6 AIR FLAP CONTROL

- a) With engine cylinder temperature sensor
 - When generator-set starts up, If the engine cylinder temperature is below the set air flap closing cylinder limit, the air flap is closed.
 - After entering safety on delay, If the engine cylinder temperature is above the set air flap opening cylinder limit, the air flap is open;
 - if engine cylinder temperature is always below the set air flap opening cylinder limit, it will stay in closed status, and generator-set cannot take load.
- b) Without engine cylinder temperature sensor or sensor is open circuit

Generator-set starts up, during the first start attempt, the air flap full block, the second start attempt, the air flap block 2/3, after the third start attempt, the air flap blocked 1/3. After the crank disconnect, air flap is open after the delay.

4.7 ATS SWITCHING CONTROL

Auto mode: mains is available, ATS switches to mains; if mains failure and generator-set is normal running, ATS switches to generator. Other status, ATS stays in mains station.

Manual mode: if close generator input is active, then generator closed; if close generator input is deactivated, then mains closed.

 **Note:** if use ATS control function, the programmable output need to be configured as GCB close output and MCB close output, meanwhile, input need to be configured as GCB close input.

5 PROTECTION

- 1) Generator over voltage shutdown: alarm occurs when the controller detects generator voltage exceeds overvoltage limit and the duration exceeds the generator abnormal delay value.
- 2) Generator under voltage shutdown: detect after generator-set normal running and alarm occurs when generator voltage is below under voltage limit and the duration exceeds the generator abnormal delay value.
- 3) Generator over frequency shutdown: it will alarm shutdown when generator frequency is above over frequency limit and duration exceeds over frequency shutdown delay.
- 4) Generator under frequency shutdown: it will detect after generator-set normal running and alarm shutdown when generator frequency is below under frequency limit and duration exceeds under frequency shutdown delay.
- 5) Low oil pressure input shutdown: detect after safety on delay, alarm shutdown when low oil pressure input is active and lasts for 2s.
- 6) Fail to start: alarm occurs when fail to start after pre-set start attempts.

6 CONNECTION



| No. | Function | Cable Size | Note |
|-----|--------------------|--------------------|--|
| 1 | B- | 2.0mm ² | Connected with negative of starter battery. |
| 2 | B+ | 2.0mm ² | Connected with positive of starter battery. Max. 20A fuse is recommended. |
| 3 | Crank Output | 1.5mm ² | B+ power is supplied by terminal 2, rated 10A. Connected with start coil of starter. |
| 4 | Fuel Output | 1.5mm ² | B+ power is supplied by terminal 2, rated 10A. |
| 5 | Ignition Control | 1.5mm ² | B- power is supplied by terminal 1, rated 10A. |
| 6 | Remote Start Input | 1.0mm ² | Aux. input 1, discrete signal input, Ground connected is active (B-). |
| 7 | Oil Pressure Input | 1.0mm ² | Aux. input 2, discrete signal input, Ground connected is active (B-). |



| No. | Function | Cable Size | Note |
|-----|------------------------|--------------------------------------|---|
| 8 | Temp Sensor | 1.0mm ² | Connect with resistor type temperature sensor. |
| 9 | Aux. Output 1 | 1.0mm ² | B- power is supplied by terminal 1, rated 1A. |
| 10 | Aux. Output 2 | 1.0mm ² | B- power is supplied by terminal 1, rated 1A. |
| 11 | Speed Signal | 1.0mm ² | Connect with ignition coil primary, and diode need to be in series. |
| 12 | S22 | Use stepper motor Comes with lead | Connect with pink cable of stepper motor. |
| 13 | S21 | | Connect with orange cable of stepper motor. |
| 14 | S12 | | Connect with yellow cable of stepper motor. |
| 15 | S11 | | Connect with blue cable of stepper motor. |
| 16 | Mains (L-N) Monitoring | 1.0 mm ² | Connect with mains output port (2A fuse is recommended) |
| 17 | Input | 1.0 mm ² | |
| 18 | Generator (L-N) | 1.0 mm ² | Connect with generator voltage output port (2A fuse is recommended) |
| 19 | Monitoring Input | 1.0 mm ² | |

 **Note:** if 5-wire system stepper motor is used, red cable need hanging in the air.

SmartGen

7 DEFINITION AND RANGE OF PARAMETERS

7.1 PARAMETER SETTINGS

Parameters which can be configured by the controller are as follows,

| No. | Items | Parameter Range | Default | Description |
|-----|------------------------|-----------------|---------|---|
| P00 | Mains Normal Delay | (0-3600)s | 10 | Time duration for confirming mains voltage from abnormal to normal or from normal to abnormal, it is used to switch ATS. |
| P01 | Mains Abnormal Delay | (0-3600)s | 5 | |
| P02 | Mians Under Volt Value | (30-360)V | 184 | it is considered mains under voltage if sample voltage is lower than the set value. When 30V is set, there is no under voltage detection. |
| P03 | Mains Over Volt Value | (30-360)V | 276 | it is considered mains over voltage if sample voltage is higher than the set value. When 360V is set, there is no over voltage detection. |
| P04 | Transfer Delay | (0-99.9)s | 1.0 | it is time interval for transferring switch from mains open to generator close or from generator open to mains close. |
| P05 | Mains Options | (0-1) | 0 | 0: AMF(mains abnormal start enabled in auto mode) 1: Display Only (only monitoring mains voltage) |
| P06 | Start Delay | (0-3600)s | 1 | Time duration from remote start signal is active to engine startup. |
| P07 | Stop Delay | (0-3600)s | 1 | Time duration from remote start signal is deactivate to engine stop. |
| P08 | Start Attempts | (1-10) | 3 | It is maximum of start attempts when starter failed to start. When reaches set attempts the fail to start alarm will be initiated. |
| P09 | Cranking Time | (3-60)s | 8 | Time of starter every time power up. |
| P10 | Crank Rest Time | (3-60)s | 10 | The waiting time before second power up when engine starts fail. |
| P11 | Safety On Delay | (1-60) | 10 | Alarms for low oil pressure under frequency and under voltage are deactivated. |
| P12 | Warming Up Time | (0-3600)s | 10 | Warming time between genset close and high speed running. |
| P13 | Cooling Time | (3-3600)s | 10 | Radiating time before stop genset, after it unloads. |
| P14 | ETS Solenoid Hold | (0-120)s | 20 | Stop electromagnet's power on time when pump unit is stopping. |
| P15 | Close Time | (0-10.0)s | 0 | Pulse width of mains close and generator close. 0s stands for constant output. |
| P16 | Engine Cylinders | (1-2) | 1 | it is used for judging starter disconnect conditions and detecting engine speed. |



| No. | Items | Parameter Range | Default | Description |
|-----|--------------------------------|-----------------|---------|--|
| P17 | Generator Poles | (2-64) | 2 | Number of engine poles. This value is used for calculating engine speed if without speed sensor . |
| P18 | Generator Abnormal Delay | (0-20.0)s | 10.0 | Alarm delay of generator under/over voltage. |
| P19 | Generator Over Volt Shutdown | (30-360)V | 264 | When generator voltage exceeds this threshold and last over the delay value, generator abnormal shutdown alarm signal will be sent. (No detection for over volt signals if it is set as 360V) |
| P20 | Generator Under Volt Shutdown | (30-360)V | 196 | When generator voltage falls below this threshold and last over the delay value, generator abnormal shutdown alarm signal will be sent. (No detection for under volt signals if it is set as 30V) |
| P21 | Under Frequency Shutdown | (0-75.0)Hz | 45.0 | When generator frequency falls below this threshold and last over the delay value, generator under frequency shutdown alarm signal will be sent. |
| P22 | Over Frequency Shutdown | (0-75.0)Hz | 57.0 | When generator frequency exceeds this threshold and last over the delay value, generator over frequency shutdown alarm signal will be sent. |
| P23 | Under Frequency Shutdown Delay | (0-60)s | 10 | Delay value of generator under frequency. |
| P24 | Over Frequency Shutdown Delay | (0-60)s | 2 | Delay value of generator over frequency. |
| P25 | Air Flap Choke Time | (0-60)s | 5 | After generator-set crank disconnected, time duration for closing air flap if without engine cylinder temperature sensor. |
| P26 | Air Flap Choke Temp. | (0-200)°C | 30 | During generator-set starts up, if cylinder temperature is lower than this value, air flap will close. |
| P27 | Air Flap Open Temp. | (0-200)°C | 60 | After generator-set crank disconnect, if cylinder temperature is higher than this value, air flap will open. |
| P28 | Aux. Output 1 | (0-9) | 5 | Default function: generator close output. Details to see 7.2 Programmable Outputs Form as bellow. |
| P29 | Aux. Output 2 | (0-9) | 6 | Default function: mains close output. Details to see 7.2 Programmable Outputs Form as bellow. |



| No. | Items | Parameter Range | Default | Description |
|-----|-----------------------------|-----------------|---------|--|
| P30 | Power On Mode Selection | (1-2) | 1 | 1: Manual Mode 2: Auto Mode |
| P31 | Module Address | (1-254) | 1 | Address communication with PC software. |
| P32 | Password | (0-9999) | 0318 | Controller password. |
| P33 | Crank Disconnect Conditions | (0-2) | 2 | 0: Generator frequency 1: Engine Speed 2: Generator frequency + engine speed It is used for judging crank disconnect condition. |
| P34 | Disconnect Engine Speed | (0-3000)r/min | 840 | When engine speed exceeds this value, generator-set is considered as start successfully and starter will be disconnected. |
| P35 | Disconnect Gen. Frequency | (0-30.0)Hz | 14.0 | When generator frequency exceeds this value, generator-set is considered as start successfully and starter will be disconnected. |
| P36 | Temp Sensor Types | (0-4) | 0 | 0: Not used 1: PT100 2: NTC-1K 3: Reserved 4: User Configured (Res.) |

Parameters which can be configured only by PC software are as follows,

| No. | Items | Range | Default | Description |
|-----|--------------------------------|-------------|---------|---|
| 1 | Pre-heat Delay | (0-300)s | 0 | Before starter power up, time for heater plug to pre-energized. |
| 2 | Start Idle Time | (0-3600)s | 0 | When start up, time for generator-set idle running. |
| 3 | Stop Idle Time | (0-3600)s | 0 | When top, time for generator-set idle running. |
| 4 | Stepper Motor Pluse Per Second | (100-500)Hz | 400 | The number of rotation steps of the motor per second |
| 5 | Stepper Motor Run Steps | (0-2000) | 128 | Number of steps are needed for motor rotating 90° calculation formula is $360 * \text{reduction ratio} / (\text{step angle} * 4)$ for example: $128 = 360 * 16 / (5.625 * 2 * 4)$ |
| 6 | Ignition Output | (0-1) | 0 | 0: Output when stop 1: Output when start |
| 7 | Fuel Output | (0-1) | 0 | 0: Fuel Output 1: ETS Output |
| 8 | Digital Input 1 | (0-6) | 1 | The function of the controller terminal 6 is configured. Default: remote start input, details to see 7.3 |



| No. | Items | Range | Default | Description |
|-----|-----------------|-------|---------|--|
| | | | | Programmable Inputs Form |
| 9 | Digital Input 2 | (0-6) | 2 | The function of the controller terminal 7 is configured. Default: low oil pressure input details to see 7.3 Programmable Inputs Form |

 **Note:** when set parameters via PC software, users are needn't to entry the password if default password (0318) is not been changed; if it is changed via PC software, users need to entry the correct password.



7.2 PROGRAMMABLE OUTPUTS CONTENT DEFINITION



| No. | Items | Function Description |
|-----|--------------------|--|
| 0 | Not Used | When this is chosen, output port won't output. |
| 1 | Common Alarm | When stop alarm is initiated, this alarm will self-lock untill alarm reset. |
| 2 | Energizse to Stop | Used for some genset which has stop electromagnet. Close before stoping idle ended. Open when "ETS Delay" ended. |
| 3 | Idle Control | Used for engine which has idles. Close before starting and open in warming up delay; Close during stopping idle process and open when stop is completed. |
| 4 | Preheat Control | Close before start, open before energize. |
| 5 | Gen Close Output | Generator close output when generator is normal running. |
| 6 | Mains Close Output | Mains close output after mains normal delay expired. |
| 7 | Air Flap Choke | Output when start engine, disconnect when air flap block delay expired or cylinder temperature reached air flap open threshold. |
| 8 | Reserved | |
| 9 | Reserved | |



7.3 PROGRAMMABLE INPUTS CONTENT DEFINITION



| No. | Items | Remark |
|-----|------------------------|--|
| 0 | Not Used | |
| 1 | Remote Start | In auto mode, generator-set starts up if this signal is active. |
| 2 | Low Oil Pressure Input | After safety on delay expired, generator alarms shutdown immidiately if this signal is active. |
| 3 | Gen Close Input | In manual mode, generator close output when this sigal is active, otherwise, mains close output. |
| 4 | Reserved | |
| 5 | Reserved | |
| 6 | Reserved | |



8 CONTROLLER FUNCTION SETTINGS

When the controller is at rest, press  for 3s, it will enter into **password entry menu** and LED will display  and first digital flashes:

- 1) Press  to plus 1, and press  to minus 1. When the number is confirmed, press  to move to the next number.
- 2) The following numbers settings are the same as step one.
- 3) After password is confirmed, controller enters into parameter setting menu and LED will

display , which is the serial number of current setting item. Press  to downturn the items and press  to upturn the items.

- 4) Press  to enter into setting status and press  or  to adjust parameter value.

When finished, re-press  to save it, and then press  to exit parameter setting status.

Note:

- a) Please change controller parameters (like crank disconnect conditions selection, digital inputs, relay outputs and delay values) in standby status, otherwise alarm shutdown or other fault information may occurs.
- b) Serial number of setting item please reference serial numbers in *7.1 parameter settings*.
- c) Over volt threshold must greater than under volt threshold, otherwise both under/over volt may occurs at the same time.
- d) Frequency of generator when crank disconnect should be set as low as possible, so as to separate starter as soon as possible.

9 COMMISSIONING

Please make sure the following checks are made before commissioning,

- a) Ensure all the connections are correct and wires diameter is suitable.
- b) Ensure that the controller DC power has fuse, controller's positive and negative connected to start battery are correct.
- c) Take proper action to prevent engine to crank success (e. g. Remove the connection wire of fuel valve). If checking is OK, make the start battery power on; choose manual mode and controller will execute routine.
- d) Press "start" button, genset will start. After the cranking times as setting, controller will send signal of Start Failure; then press "stop" to reset controller.
- e) Recover the action to prevent engine to crank success (e. g. Connect wire of fuel valve), press start button again, genset will start. If everything goes well, genset will normal running. During this time, please watch for engine's running state and AC generator's voltage and frequency. If abnormal, stop genset and check all wires connection according to this manual.
- f) Any other questions please contact with SmartGen service personnel.

10 TYPICAL APPLICATION

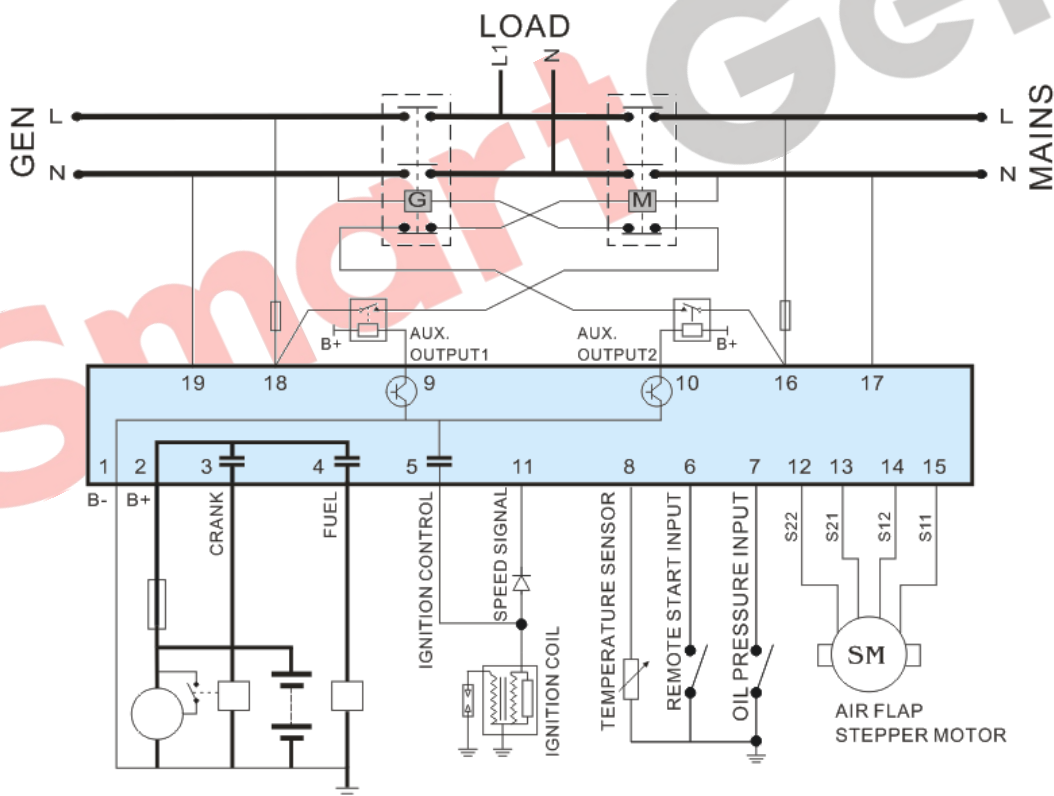

MGC120 Wiring Connection 1

Note:

- 1) S11、S12、S21、S22 separately connect with blue wire, yellow wire, orange wire and pink wire of stepper motor.
- 2) No.11 terminal must connect in serial with diode.
- 3) The maximum incoming current for programmable output 1 and output 2 is 1A.

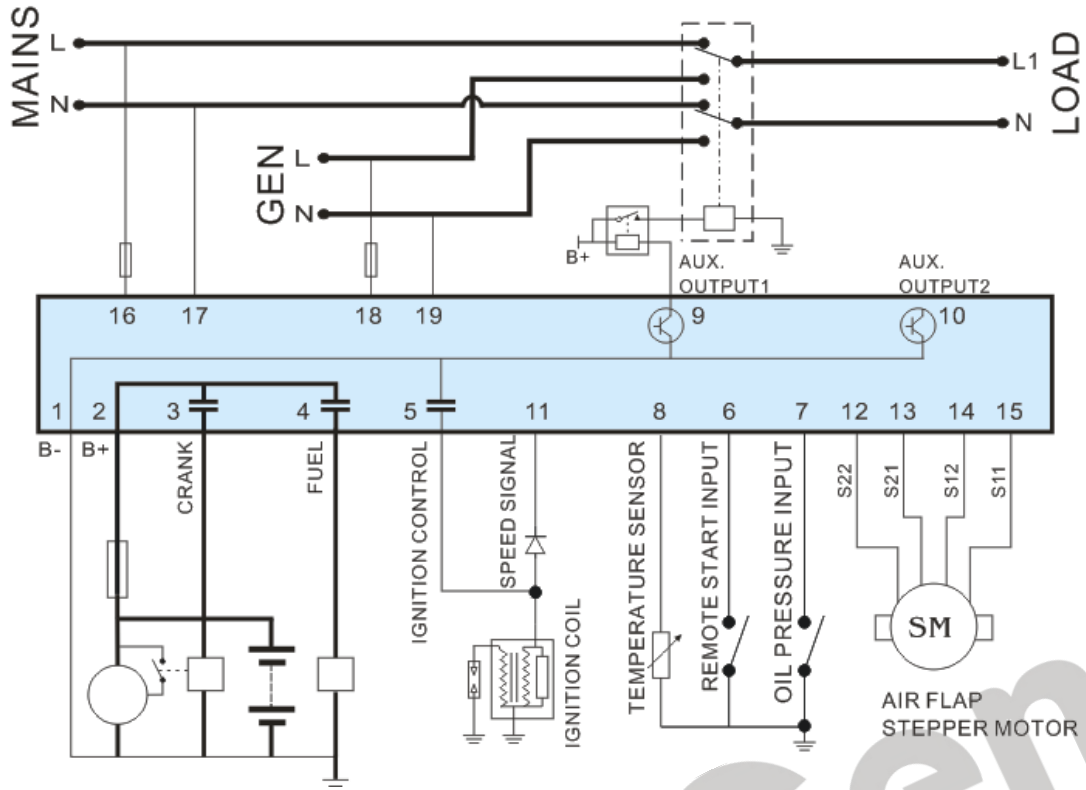

MGC120 Wiring Connection 2

▲ Note: Programmable output 1 set as "Generator Close Output".

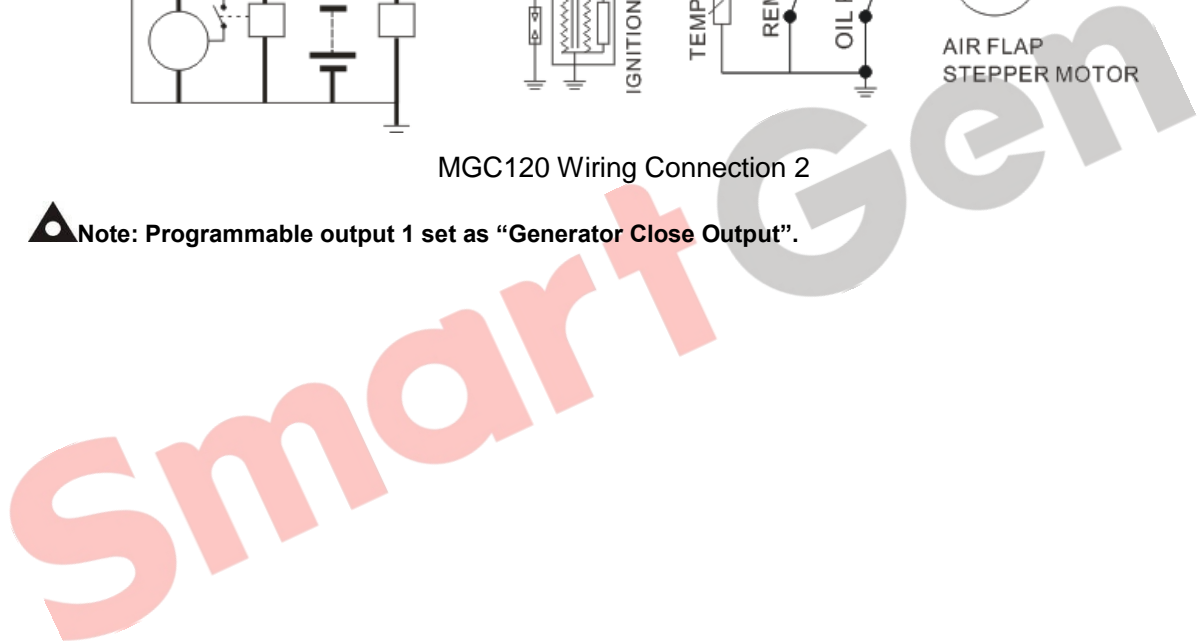

11 INSTALLATION

11.1 FIXING CLIPS

- Controller is panel built-in design; it is fixed by clips when installed.
 - Withdraw the fixing clip screw (turn anticlockwise) until it reaches proper position.
 - Pull the fixing clip backwards (towards the back of the module) ensuring two clips are inside their allotted slots.
 - Turn the fixing clip screws clockwise until they are fixed on the panel.
- ▲ **Note:** Care should be taken not to over tighten the screws of fixing clips.

11.2 OVERALL AND CUTOUT DIMENSIONS

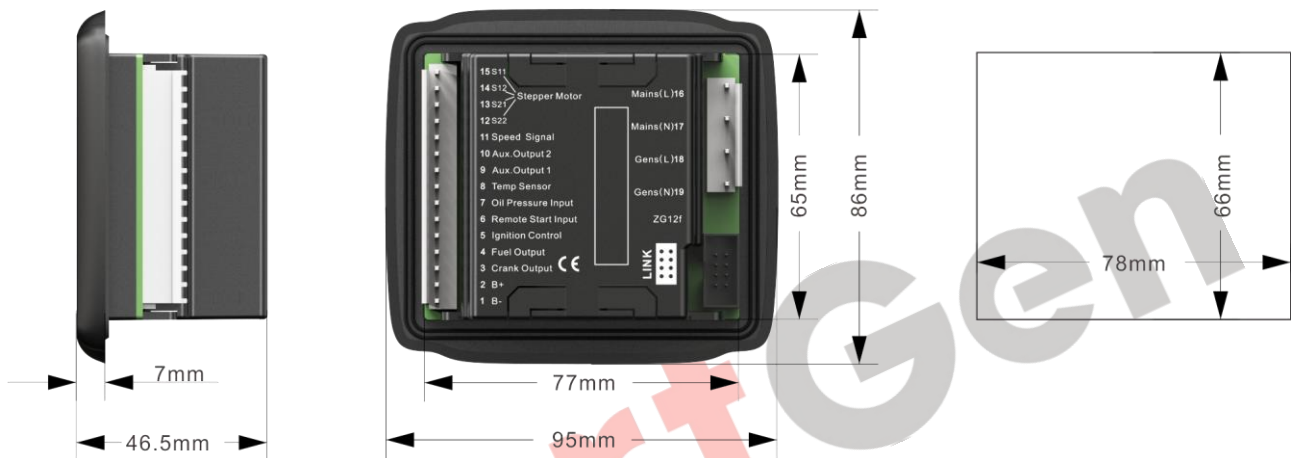

1) Battery Voltage Input

▲ **NOTE:** MGC120 controller can suit for widely range of battery voltage DC12V. Negative of battery must be connected with the engine shell soundly. The diameter of wire which from power supply to battery must be over 1.5mm². If floating charge configured, please firstly connect output wires of charger to battery's positive and negative directly, then, connect wires from battery's positive and negative to controller's corresponding input ports in order to prevent charger disturbing the controller's normal working.



WARNING: In running process, removing start battery is strictly prohibit.

2) Withstand Voltage Test

▲ **CAUTION:** When controller has been installed in control panel, if the high voltage test is needed, please disconnect controller's all terminals in order to prevent high voltage into controller and damage it.

12 FAULT FINDING

| Symptoms | Possible Solutions |
|---|--|
| Controller no response with power. | Check starting batteries; Check controller connection wirings; Check DC fuse. |
| Genset shutdown | Check alternator voltage. |
| Low oil pressure alarm after crank disconnected | Check oil pressure sensor and its connections. |
| Shutdown Alarm in running | Check related switch and its connections according to the information on LED; |
| Crank not disconnect | Check fuel oil circuit and its connections; Check starting batteries; Check speed sensor and its connections; Refer to engine manual. |
| Starter no response | Check starter connections; Check starting batteries. |
| Air flap stepper motor contrarotation | Check order of wiring connection of stepper motor. |