

SmartGen

MAKING CONTROL SMARTER

HGM9560

BUS TIE MAINS PARALLEL UNIT

USER MANUAL



郑州众智科技股份有限公司
SMARTGEN(ZHENGZHOU)TECHNOLOGY CO.,LTD.

SmartGen Registered trademark

No. 28 Xuemei Street, Zhengzhou, Henan, China

Tel: +86-371-67988888/67981888/67992951

+86-371-67981000(overseas)

Fax: +86-371-67992952

Web: www.smartgen.com.cn/

www.smartgen.cn/

Email: sales@smartgen.cn



All rights reserved. No part of this publication may be reproduced in any material form (including photocopying or storing in any medium by electronic means or other) without the written permission of the copyright holder. SmartGen reserves the right to change the contents of this document without prior notice.

Table 1 Version History

Date	Version	Note
2013-12-30	1.0	Original release.
2024-01-03	1.1	1. Add descriptions of mains trip function; 2. Modify the parameter contents of user manual to be the same with controller.
2024-11-05	1.2	1. Add mains over current 1/2, stop mode MB control and maintenance settings; 2. Add mains switch control unavailable and mains switch control unavailable feedback for input items.
2025-02-13	1.3	Modify the working and storage temperature ranges.

This manual is suitable for HGM9560 bus tie mains parallel unit only.

Table 2 Clarification of Notation

Sigh	Instruction
 NOTE	Highlights an essential element of a procedure to ensure correctness.
 CAUTION!	Indicates a procedure or practice, which, if not strictly observed, could result in damage or destruction of equipment.
 WARNING!	Indicates a procedure or practice, which could result in injury to personnel or loss of life if not followed correctly.

CONTENTS

1	OVERVIEW	5
2	PERFORMANCE AND CHARACTERISTICS.....	6
3	SPECIFICATION	8
4	OPERATION.....	9
4.1	INDICATOR LIGHT	9
4.2	PUSHBUTTONS	10
4.3	LCD DISPLAY	11
4.3.1	MAIN DISPLAY	11
4.3.2	USER MENU AND PARAMETERS SETTING MENU.....	12
4.4	AUTO START/STOP OPERATION	14
4.5	MANUAL START/STOP OPERATION.....	15
5	MULTIPLE MAINS OPERATION	17
6	PROTECTIONS	18
6.1	WARNING ALARMS	18
6.2	TRIP AND STOP ALARMS.....	19
6.3	TRIP ALARM.....	20
6.4	MAINS TRIP ALARM.....	20
7	WIRING CONNECTION.....	21
8	SCOPES AND DEFINITIONS OF PROGRAMMABLE PARAMETERS	24
8.1	CONTENTS AND SCOPES OF PARAMETERS.....	24
8.2	ENABLE DEFINITION OF PROGRAMMABLE OUTPUT PORTS.....	31
8.2.1	DEFINED COMBINATION OUTPUT	32
8.3	DEFINED CONTENTS OF DIGITAL INPUT PORTS (ALL ACTIVE WHEN CONNECT TO GROUND (B~)).....	33
9	PARAMETERS SETTING	35
10	COMMISSIONING.....	36
11	MAINS PARALLEL.....	37
11.1	BUS CONTROL MODE	37
11.2	MAINS CONTROL MODE.....	38
11.3	LOAD TAKEOVER MODE.....	39
11.4	AMF MODE.....	40
11.5	ISLAND MODE	41
12	TYPICAL APPLICATION.....	42
13	TYPICAL APPLICATION.....	43
14	INSTALLATION.....	45
15	USB	46
16	FAULT FINDING.....	47

1 OVERVIEW

HGM9560 Bus Tie Mains Parallel Unit is designed for manual/auto parallel system which composed by gensets and one-way/multi-way mains. It allows automatic start/stop and parallel running function. It fit with LCD display, graphic display, optional Chinese, English and other languages interface, and it is reliable and easy to use.

HGM9560 Bus Tie Mains Parallel Unit has multiple running states when it is parallel with mains: Genset output fixed active power and fixed reactive power; Mains peak lopping; Provide fixed power to mains; Load takeover; No-break return to mains supply.

The powerful 32-bit Microprocessor contained within the unit allows for precision parameters measuring, fixed value adjustment, time setting and set value adjusting and etc..Majority parameters can be configured from front panel, and all parameters can be configured by USB interface (or RS485) to adjust via PC. It can be widely used in all types of automatic genset parallel system with compact structure, simple connections and high reliability.

2 PERFORMANCE AND CHARACTERISTICS

- With ARM-based 32-bit SCM, high integration of hardware and more reliable;
- 480x272 TFT LCD with backlight, multilingual interface (including English, Chinese or other languages) which can be chosen at the site, making commissioning convenient for factory personnel;
- Improved TFT LCD wear-resistance and scratch resistance due to hard screen acrylic;
- Silicon panel and pushbuttons for better operation in high/low temperature environment;
- RS485 communication port enables remote control, remote measuring, remote communication via ModBus protocol.
- Suitable for 3-phase 4-wire, 3-phase 3-wire, single phase 2-wire, and 2-phase 3-wire systems with voltage 120/240V and frequency 50/60Hz;
- Collects and shows 3-phase voltage, current, power parameter and frequency of Bus/mains.

Mains	Bus
Line voltage (Uab, Ubc, and Uca)	Line voltage (Uab, Ubc, and Uca)
Phase voltage (Ua, Ub, and Uc)	Phase voltage (Ua, Ub, and Uc)
Phase sequence	Phase sequence
Frequency (Hz)	Frequency (Hz)
Current IA, IB, IC	Current IM
Each phase and total active power kW	Active power kW
Each phase and total reactive power kvar	Reactive power kvar
Each phase and total apparent power kVA	Apparent power kVA
Each phase and average power factor PF	Power factor PF
Accumulate total gen power kWh、kvarh、kVAh	
Rate of Change of Frequency ROCOF	
Vector Shift VS	
Earth current I _E	
Negative Sequence Current I _{NB}	

- Perfect mains split protection: over/under frequency, over/under voltage, ROCOF and vector shift;
- Synchronization parameters : Voltage Difference Between Bus and Mains, Frequency Difference Between Bus and Mains, Phase Difference Between Bus and mains;
- Multiple running modes in auto state: AMF (Automatic Mains Failure), Island Mode, Fixed Power Output/Input, Peak Lopping Mode and Load Takeover Mode;
- Ramp on and ramp off function;
- Control and Protection: automatic start/stop of the gen-set, ATS (Auto Transfer Switch) control with perfect fault indication and protection function;

- All output ports are relay output;
- Parameter setting: parameters can be modified and stored in internal EEPROM memory and cannot be lost even in case of power outage; most of them can be adjusted using front panel of the controller and all of them can be modified using PC via USB or RS485 ports;
- Widely power supply range DC(8~35)V, suitable to different starting battery voltage environment;
- Event log, real-time clock, scheduled start & stop generator (can be set as start genset once a day/week/month whether with load or not);
- Accumulative total electric energy A and B. Users can reset it as 0 and re-accumulative the value which make convenience to users to count the total value as their wish.
- With maintenance function. Actions (warning, trip and stop, shutdown) can be set when maintenance time out;
- All parameters used digital adjustment, instead of conventional analog modulation with normal potentiometer, more reliability and stability;
- IP55 waterproofness level can be achieved with the help of rubber-ring gasket between shell and control panel.
- Metal fixing clips enable perfect in high temperature environment ;
- Modular design, self extinguishing ABS plastic shell, pluggable terminal, built-in mounting , compact structure with easy installation ;

Table 3 Performance Parameters

Parameter	Details
Working Voltage Range	DC8V ~ DC35V, DC reverse protection Resolution: 0.1V Accuracy:1%
	DC12V ~DC30V, DC reverse protection (UL Certification) Resolution: 0.1V Accuracy:1%
Overall Consumption	<4W (Standby mode: ≤2W)
AC Input: 3 Phase 4 Wire 3 Phase 3 Wire Single Phase 2 Wire 2 Phase 3 Wire	AC15V - AC360V (ph-N) AC30V - AC620V (ph- ph) AC15V - AC360V (ph-N) AC15V - AC360V (ph-N)
Alternator Frequency	50Hz/60Hz
Flexible Relay Output 1	7A DC28V power supply output
Flexible Relay Output 2	7A DC28V power supply output
Flexible Relay Output 3	7A DC28V power supply output
Flexible Relay Output 4	7A AC250V volts free output
Flexible Relay Output 5	7A AC250V volts free output
Flexible Relay Output 6	7A AC250V volts free output
Flexible Relay Output 7	16A DC28V power supply output
Flexible Relay Output 8	16A DC28V power supply output
Digital Input 1~7	Low limit voltage is 1.2V, high limit voltage is 60V.
CT Secondary Current	Rated: 5A
RS485	Isolated, half-duplex, 9600 baud rate, max. communication length 1000m
MSC CAN	Isolated, max. communication length 250m, using Belden 9841 cable or equivalent.
Vibration	5Hz~8Hz: ±7.5mm 8Hz~500Hz: 2g IEC 60068-2-6
Shock	50g _n , 11ms, half-sine, three consecutive shocks are applied in each of the three mutually perpendicular directions, i.e. a total of 18 times. IEC 60068-2-27
Bump Test	20g _n , 16ms, half-sine IEC 60255-21-2
Safety Requirement	According to EN 61010-1 installation category (over voltage category) III, 300V, pollution class 2, altitude 3000m
Case Dimensions	266mm x 182mm x 45mm
Panel Cutout	214mm x 160mm
Working Temperature:	(-40~+70)°C
Working Humidity	(20~93)%RH
Storage Temperature:	(-40~+80)°C
Protection Level	IP55 Gasket

Parameter	Details
Insulation Intensity	Apply AC2.2kV voltage between high voltage terminal and low voltage terminal; The leakage current is not more than 3mA within 1min.
Product Compliance	GB/T 37089 Reciprocating internal combustion engine driven alternating current generating sets—Controller
Weight	0.95kg

4 OPERATION

4.1 INDICATOR LIGHT



Fig.1 HGM9560 Front Panel

NOTE: Selected light indicators description.

Table 4 Warning indicator and Alarm indicator

Alarm Type	Warning Indicator	Alarm Indicator
Warning	Slow flashing	Slow flashing
Trip Alarm	Slow flashing	Slow flashing
Shutdown Alarm	Off	Fast flashing
Trip and Stop Alarm	Off	Fast flashing

Running indicator: illuminated from crank disconnect to ETS while off during other periods.

Bus normal light: It is light on when bus is normal; flashing when bus state is abnormal; off when there is no bus power.

Mains normal indicator: It is illuminated when mains is normal; flashing when mains state is abnormal; off when there is no mains power.

4.2 PUSHBUTTONS





Table 5 Keys Functions

Icon	Function	Description
	Stop	When the controller is in Auto/Manual mode, press this button will stop the system generators (if the generators are in Auto mode). Reset alarm in stop mode; Lamp test (press at least 3 seconds);
	Start	When the controller is in Manual mode, press this button will start the system generators (if the generators are in Auto mode).
	Manual Mode	Press this key and controller enters in Manual mode.
	Auto Mode	Press this key and controller enters in Auto mode.
	Mute/Reset Alarm	Alarming sound off; If trip alarm occurs, pressing the button at least 3 seconds can reset this alarm.
	Bus Close/Open	Can control bus to switch on or off in Manual mode.
	Mains Close/Open	Can control mains to switch on or off in Manual mode.
	Up/Increase	1) Screen scroll; 2) Up cursor and increase value in setting menu.
	Down/Decrease	1) Screen scroll; 2) Down cursor and decrease value in setting menu.
	Left	1) Screen scroll; 2) Left move cursor in setting menu.
	Right	1) Screen scroll; 2) Right move cursor in setting menu.
	Set/Confirm	1) Pressing and holding for more than 3 seconds enters parameter setting menu; 2) In settings menu confirms the set value.
	Exit	1) Return to main menu; 2) Return to previous menu in setting menu.

⚠ WARNING: Default password is 00318, user can change it in case of others change the advanced parameters setting. Please clearly remember the password after changing. If you forget it, please contact Smartgen services and send all PD information in the controller page of **"ABOUT"** to us.

4.3 LCD DISPLAY

4.3.1 MAIN DISPLAY

Main screen show pages; use   to scroll the pages and   to scroll the screen.

★**Main Screen**, including as below,

Mains: voltage, frequency, current, active power, reactive power

Bus: voltage, frequency, active power, reactive power

Some status

★**Status**, including as below,

Module status, mains status, ATS status

★**Bus**, including as below,

Phase voltage, line voltage, frequency, phase sequence, multi-genset total power

 **NOTE:** If load current transformer is enabled, this page also includes: current, active power, reactive power, apparent power, power factor.

★**Mains**, including as below,

Phase voltage, line voltage, frequency, phase sequence, current, active power(positive and negative), total active power (positive and negative), reactive power(positive and negative), total reactive power (positive and negative), apparent power, total apparent power, power factor(positive and negative), average power factor (positive and negative), accumulated energy (**kWh, kVarh, kVAh**), earth current, negative sequence current, ROCOF (rate of change of frequency), VS (vector shift).

★**SNYC**, including as below,

Voltage difference, frequency difference, angle difference, Bus active power percentage, Bus target active power percentage, Bus reactive power percentage, Bus target reactive power percentage, MSC status

★**Alarm**

Display all alarm information (warning alarm, shutdown alarm, trip and stop alarm, trip alarm, mains trip).

★**Event log**

Make records about all start/stop events (shutdown alarm, trip and stop alarm, manual /auto start or stop) and the real time when alarm occurs.

★**Others**, including,

Time and Date, maintenance due, input/output ports status.

★**About**, including,

Issue time of software and hardware version, product PD number.

4.3.2 USER MENU AND PARAMETERS SETTING MENU

Press  key for more than 3s to enter into user manual.

★Parameter

After entering the correct password (factory default password is 00318) you can enter parameter settings screen.

★Language

Selectable Chinese, English and others (default: Espanol)

★Clear users' accumulation

Can clear total electric energy A and B.

Parameter setting including as following,

★Mains setting

★Timer settings

★Battery setting

★Bus settings

★Breaker settings

★Input port settings

★Output port settings

★Module settings





★Scheduled Run Settings





★Scheduled Not Run Settings





★Maintenance settings



★Synchronization settings







Example:





Return	>Start Delay	Form1: Use   to scroll settings,  to enter settings (form 2),  to exit settings menu.
Mains setting	>Stop Delay	
Timers setting >		
Battery setting		
Bus setting		
Breaker setting		
Input setting		
Output setting		
Module setting		
Scheduled Run Setting		
Scheduled Not Run Setting		
Maintenance		
Synchronization setting		



Return	>Start Delay	Form 2: Use   to scroll settings,  to enter settings (form 4),  to return to previous menu. (form 1)
Mains setting	>Stop Delay	
Timers setting >		
Battery setting		
Bus setting		
Breaker setting		
Input setting		
Output setting		
Module setting		
Scheduled Run Setting		
Scheduled Not Run Setting		
Maintenance		
Synchronization setting		

Return	>Start Delay	Form 3: Use   to scroll settings,  to confirm settings (form 4),  to return to previous menu. (form 1)
Mains setting	>Stop Delay	
Timers setting >		
Battery setting		
Bus setting		
Breaker setting		
Input setting		
Output setting		
Module setting		
Scheduled Run Setting		
Scheduled Not Run Setting		
Maintenance		
Synchronization setting		

> Start Delay		Form 4: Press  to enter settings (form 5),  to return to previous menu. (form 6).
> Stop Delay	00008	

> Start Delay		Form 5: Press   to change cursor position,   are used for changing cursor value,  to confirm setting (form 4),  to exit setting (form 4).
> Stop Delay	00008	

> Start Delay	00008	Form 6: Use   to scroll settings.  to enter settings (form 4),  to return to previous menu. (form 1).
> Stop Delay		

 **NOTE:** Pressing  can exit setting directly during setting.

4.4 AUTO START/STOP OPERATION

Auto mode is selected by pressing the  button; a LED besides the button will illuminate to confirm the operation.

Automatic Start Sequence:

1. When remote start (on-load) input is active or mains is abnormal, “Start Delay” timer is initiated; “Start Delay” countdown will be displayed on LCD;
2. When start delay is over, the controller will issue a start command, “Start Request XXs” information will be displayed on LCD;
3. Any available 9560 in auto mode will be issued with a start signal. Please refer to the 9510 operating manual for further details of the start sequence.
4. Once the Minimum number of sets have synchronized onto the bus, the 9560 will enter into normal running:
 - a) If mains switch didn’t close, then bus close relay activate.
 - b) If mains switch already closed, the controller will adjust speed and voltage to synchronize bus with mains; when synchronism requirements has been achieved, bus close signal will be initiated and the bus will be paralleled with the mains. Once the bus has synchronized to the mains, the power will be ramped off the bus.
5. If the number of the synchronized set is less than the Minimum number after the “Start Request” delay is over, then the “Too Few Modules” alarm will be initiated.

 **Note:** When started via “Remote Start (off Load)” input, same procedures as above but bus close relay deactivated, moreover, bus off load. When started via “Remote Start (Demand)” input, same procedures as above if the start requirements has been achieved (e.g. when the load has exceed the set value in shave lopping mode).

Automatic Stop Sequence,

- 1) When the “Remote Start” signal is removed, and moreover, mains is normal, the Stop Delay is initiated.
- 2) Once this “stop delay” has expired,
 - a) If mains switch didn’t close, then bus open relay activate.
 - b) If mains switch already closed, first of all, the controller will transfer load to mains, and only then bus open relay activate.

- 3) The controller will issue a stop command and the genset is in “At Rest” mode.
- 4) Any available 9560 in auto mode will be issued with a stop signal. Please refer to the 9510 operating manual for further details of the stop sequence.

4.5 MANUAL START/STOP OPERATION

Manual mode is selected by pressing the  button; a LED besides the button will illuminate to confirm the operation.

Manual Start Operation:

1. Press  button to start the genset, the controller will issue a start command, “Start Request XXs” information will be displayed on LCD;
2. Any available 9560 in auto mode will be issued with a start signal. Please refer to the 9510 operating manual for further details of the start sequence.
3. Once the Minimum number of sets have synchronized onto the bus, the 9560 will enter into normal running:
4. If the number of the synchronized set is less than the Minimum number after the “Start Request” delay is over, then the “Too Few Modules” alarm will be initiated.

Manual Transfer Procedures

Bus Close Operation: During genset is normal running, press Bus Close Button .

- 1) If mains switch didn't close, then bus close relay activate.
- 2) If mains switch already closed, the controller will adjust speed and voltage to synchronize bus with mains; when synchronism requirements have been achieved, bus close signal will be initiated and the bus will be paralleled with the mains. Once the bus has synchronized to the mains, the power will be ramped off the mains.

Bus Open Operation: Press Bus Open Button .

- 1) If mains switch didn't close, then bus open relay activate.
- 2) If mains switch already closed, first of all, the controller will transfer load to mains, and only then bus open relay activate.

Mains Close Operation: During mains is in normal status, press Mains Close Button .

- 1) If bus switch didn't close, then mains close relay activates.
- 2) If bus switch already closed, the controller will adjust speed and voltage to synchronize bus with mains; when synchronism requirements has been achieved, mains close signal will be initiated and the mains will be paralleled with the bus. Once the mains has synchronized to the bus, the power will be ramped off the bus.

Mains Open Operation: Press mains Open Button :

- 1) If mains switch didn't close, then mains open relay activates.
- 2) If mains switch already closed, first of all, the controller will transfer load to bus, and only then mains open relay activate.

Manual Stop Operation:

- 1) Stop mode is selected by pressing the  button; a LED besides the button will illuminate to confirm the operation:
 - a) If mains switch didn't close, then bus open relay activate.
 - b) If mains switch already closed, first of all, the controller will transfer load to mains, and only then bus open relay activate.
- 2) The controller will issue a stop command and the genset is in "At Rest" mode.
- 3) Any available 9560 in auto mode will be issued with a stop signal. Please refer to the 9510 operating manual for further details of the stop sequence.

5 MULTIPLE MAINS OPERATION

In a multiple mains system, the gensets are controlled by more than one 9560 mains controller and used to provide power to multiple loads.

Should one or more of the mains supplies fail, the generators are started and supply power to the load. If more than one mains supply has failed, the loads are transferred to the generators one by one.

If one mains supply returns, the 9560 connected to that mains supply will synchronise the generators with the mains and affect a no-break changeover. The generators continue to supply power to the remaining loads.

If more than one mains supply returns at the same time, then the 9560 with the highest priority will take control of the generators and affect a no-break changeover back to the mains supply.

HGM9560 priority fall into two types: status priority and module priority.

If status priorities are different, then the HGM9560 priority is up to the status priorities;

If status priorities are same, then the HGM9560 priority is up to the module priority;

The module priority can be set while the status priority can not.

Table 6 Status Priority

Priority	Condition
<div style="text-align: center;"> <p>Highest</p>  <p>Lowest</p> </div>	Auto mode, mains failed, bus not on load
	Auto mode, mains has returned
	Auto mode, mains failed, bus on load
	Auto mode, mains available, requesting control over generators
	Manual mode, sets running or about to run (start button has been pressed)
	Auto mode, mains available
	Manual mode, sets not running
	Stop mode

6 PROTECTIONS

6.1 WARNING ALARMS

Warnings are not shutdown alarms and do not affect the operation of the gen-set. Warning alarms does not lead to shutdown. Warning alarms types are as follows:

Table 7 Warning Alarms

No	Type	Description
1	Battery Over Volt	When the controller detects that the battery voltage has exceeded the pre-set value, it will initiate a warning alarm.
2	Battery Under Volt	When the controller detects that the battery voltage has fallen below the pre-set value, it will initiate a warning alarm.
3	Bus Breaker Fail	When the controller detects that the Bus Breaker Fail is not configured in the input port, it will initiate a warning alarm.
4	Mains Breaker Fail	When the controller detects that the Mains Breaker Fail is not configured in the input port, it will initiate a warning alarm.
5	Digital Input	When the digit input port is set as User Configured and the action select "Warn", it will initiate a warning alarm.
6	Fail to sync	When the controller does not detect synchronization signal within the pre-set synchronization time, it will initiate a warning alarm.
7	Min Sets Not Reached	When the controller detects fewer modules on the MSC link than the minimum number configured in the unit, it will initiate a warning alarm.
8	Maintenance Due	When count down time is 0 and the action select "Warn", it will initiate a warning alarm.
9	Insufficient Capacity	When the controller detects that the bus power percentage has exceeded 100%, and the action select "Warn", it will initiate a warning alarm.
10	Output Mains Power Limit	When the controller detects that the mains power has exceeded the pre-set value, and the action selects "Warn", it will initiate a warning alarm.
11	Mains Over Current 1	When the current of any phase of mains is over than the over current 1 pre-set value, and the action selects" Warn", it will initiate a warning signal.
12	Mains Over Current 2	When the current of any phase of mains is over than the over current 2 pre-set value, and the action selects" Warn", it will initiate a warning signal.

6.2 TRIP AND STOP ALARMS

When the controller detects trip and stop signal, it immediately disconnects generator breaker, which leads to unloading and then generator is cooling down and stopped.

Table 8 Trip and Stop Alarms

No	Type	Description
1	Digital Input	When the digit input port is set as User Configured and the action select "Trip and Stop", it will initiate a trip and stop alarm.
2	Mains Over Frequency	When the controller detects that the mains frequency has exceeded the pre-set value, it will initiate a trip and stop alarm.
3	Mains Under Frequency	When the controller detects that the mains frequency has fallen below the pre-set value, it will initiate a trip and stop alarm.
4	Mains Over Voltage	When the controller detects that the mains voltage has exceeded the pre-set value, it will initiate a trip and stop alarm.
5	Mains Under Voltage	When the controller detects that the mains voltage has fallen below the pre-set value, it will initiate a trip and stop alarm.
6	Mains ROCOF	When the controller detects that the rate of change of frequency has exceeded the pre-set value, it will initiate a trip and stop alarm.
7	Mains Vector Shift	When the controller detects that the mains vector shift has exceeded the pre-set value, it will initiate a trip and stop alarm.
8	Maintenance Due	When count down time is 0 and the action select "Trip and Stop", it will initiate a trip and stop alarm.
9	Insufficient Capacity	When the controller detects that the bus power percentage has exceeded 100%, and the action select "Trip and Stop", it will initiate a trip and stop alarm.
10	MSC Too Few Sets	When the controller detects fewer modules on the MSC link than the minimum number configured in the unit, it will initiate a trip and stop alarm.

6.3 TRIP ALARM

On initiation of the trip condition the controller will de-energize the 'Close Generator' Output without stop the generator.

Table 9 Trip Alarms

No.	Type	Description
1	Digital Input	When the digit input port is set as user configured and the action select "Trip", it will initiate a trip alarm.
2	Fail to sync	When the controller does not detect synchronization signal within the pre-set synchronization time, it will initiate a trip alarm.
3	Bus Breaker Fail	When the controller detects that the Bus Breaker Fail is not configured in the input port, it will initiate a trip alarm.
4	Mains Breaker Fail	When the controller detects that the Mains Breaker Fail is not configured in the input port, it will initiate a trip alarm.
5	Insufficient Capacity	When the controller detects that the bus power percentage has exceeded 100%, and the action select "Trip", it will initiate a trip alarm.

6.4 MAINS TRIP ALARM

When controller detects the signal of mains trip, it will realize the output of mains open.

Table 10 Mains Trip

No.	Type	Description
1	Mains Trip of Input Port	When digital input port selection is user defined and the configuration is mains trip, the controller will initiate a signal of mains trip after the input port is active.
2	Output Mains Power Limit	When the controller detects that the mains power has exceeded the pre-set value, and the action select "Trip and Stop", it will initiate a trip and stop alarm.
3	Mains Over Current 1 Trip	When the current of any phase of mains is over than the over current 1 pre-set value, and the action selects "Mains Trip", it will initiate a tripping signal.
4	Mains Over Current 2 Trip	When the current of any phase of mains is over than the over current 2 pre-set value, and the action selects "Mains Trip", it will initiate a tripping signal.

7 WIRING CONNECTION

HGM9560 controller's rear as following:

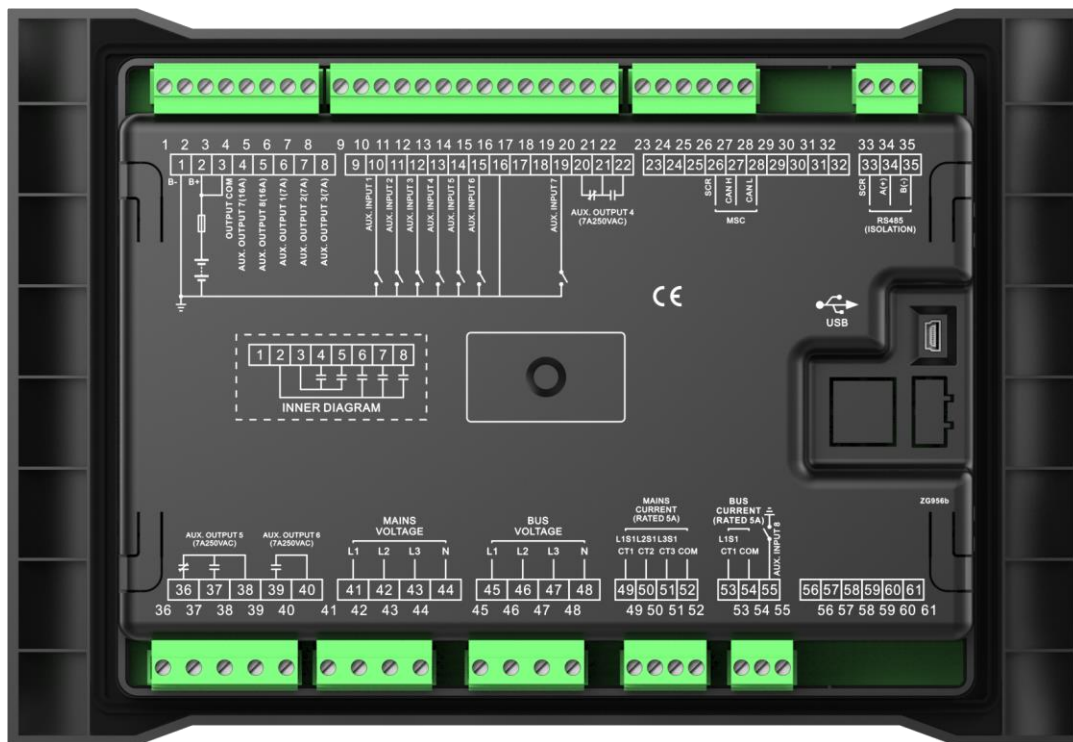



Fig.2 Controller Back Panel

Table 11 Description of Terminal Connection

NO.	Functions	Cable Size	Remark	
1	DC input B-	2.5mm ²	Connected with negative of starter battery.	
2	DC input B+	2.5mm ²	Connected with positive of starter battery. If wire length is over 30m, better to double wires in parallel. Max. 20A fuse is recommended.	
3	COM Output 7,8	2.5mm ²	Connected with B+.	
4	Aux. output 7	1.5mm ²	B+ is supplied by 3 point, rated 16A.	
5	Aux. output 8	1.5mm ²	B+ is supplied by 3 point, rated 16A.	
6	Aux. output 1	1.5mm ²	B+ is supplied by 2 point, rated 7A.	Details see form 2.
7	Aux. output 2	1.5mm ²	B+ is supplied by 2 point, rated 7A.	
8	Aux. output 3	1.5mm ²	B+ is supplied by 2 point, rated 7A.	
9	Reserved	/	This is reserved terminals, do not connect to wire.	
10	Aux. input 1	1.0mm ²	Ground connected is active (B-)	Details see form 3.
11	Aux. input 2	1.0mm ²	Ground connected is active (B-)	
12	Aux. input 3	1.0mm ²	Ground connected is active (B-)	

NO.	Functions	Cable Size	Remark	
13	Aux. input 4	1.0mm ²	Ground connected is active (B-)	
14	Aux. input 5	1.0mm ²	Ground connected is active (B-)	
15	Aux. input 6	1.0mm ²	Ground connected is active (B-)	
16-18	Reserved	/	This is reserved terminals, do not connect to wire.	
19	Aux. input 7	1.0mm ²	Ground connected is active (B-)	Details see form 3.
20	Aux. output 4	1.5mm ²	Normally close outputs, rated 7A.	Details see form 2.
21			Public points of relay	
22			Normally open outputs, rated 7A.	
23-25	Reserved	/	This is reserved terminals, do not connect to wire.	
26	MSC CAN	/	Impedance-120Ω shielding wire is recommended, its single-end earthed.	
27	MSC CAN H	0.5mm ²		
28	MSC CAN L	0.5mm ²		
33	RS485	/	Impedance-120Ω shielding wire is recommended, its single-end earthed.	
34	RS485+	0.5mm ²		
35	RS485-	0.5mm ²		
36	Aux. output 5	2.5mm ²	Normally close outputs, rated 7A.	Details see form 2.
37		2.5mm ²	Normally open outputs, rated 7A.	
38		2.5mm ²	Public points of relay	
39	Aux. output 6	2.5mm ²	Normally open outputs, rated 7A.	
40		2.5mm ²	Public points of relay	
41	Mains A-phase voltage sensing input	1.0mm ²	Connected to A-phase of mains (2A fuse is recommended).	
42	Mains B-phase voltage sensing input	1.0mm ²	Connected to B-phase of mains (2A fuse is recommended).	
43	Mains C-phase voltage sensing input	1.0mm ²	Connected to C-phase of mains (2A fuse is recommended).	
44	Mains N-wire input	1.0mm ²	Connected to N-wire of mains.	
45	Genset A-phase voltage sensing input	1.0mm ²	Connected to A-phase of genset (2A fuse is recommended).	
46	Genset B-phase voltage sensing input	1.0mm ²	Connected to B-phase of genset (2A fuse is recommended).	
47	Genset C-phase voltage sensing input	1.0mm ²	Connected to C-phase of genset (2A fuse is recommended).	
48	Genset N-wire input	1.0mm ²	Connected to N-wire of genset.	
49	Mains CT A-phase sensing	1.5mm ²	Externally connected to secondary coil of current	

NO.	Functions	Cable Size	Remark	
	input		transformer (rated 5A).	
50	Mains CT B-phase sensing input	1.5mm ²	Externally connected to secondary coil of current transformer (rated 5A).	
51	Mains CT C-phase sensing input	1.5mm ²	Externally connected to secondary coil of current transformer (rated 5A).	
52	Mains CT COM	1.5mm ²	See following section entitled <i>Installation</i> .	
53	Bus Current	1.5mm ²	Externally connected to secondary coil of Bus CT A-phase (rated 5A).	
54		1.5mm ²		
55	Aux. input 8	1.0mm ²	Ground connected is active (B-)	Details see form 3.

 **NOTE:** USB ports in controller rear panel are configurable parameter ports, user can directly program controller via PC.

8 SCOPES AND DEFINITIONS OF PROGRAMMABLE PARAMETERS

8.1 CONTENTS AND SCOPES OF PARAMETERS

Table 12 Contents and Scopes of Parameters

No.	Items	Parameters	Defaults	Description
Mains Setting				
Mains Setting-Basic				
1	AC System	(0~3)	0	0: 3P4W; 1: 3P3W; 2: 2P3W; 3: 1P2W.
2	Rated Voltage	(30~30000)V	230	Standard for checking mains over/under voltage. (It is primary voltage when using voltage transformer; it is line voltage when AC system is 3P3W while it is phase voltage when using other AC system).
3	Rated Frequency	(10.0~75.0)Hz	50.0	Standard for checking mains over/under frequency.
4	Normal Time	(0~3000)s	10	The delay from mains abnormal to normal.
5	Abnormal Time	(0~3000)s	5	The delay from mains normal to abnormal.
6	Volt. Trans.(PT)	(0~1)	0	0: Disable; 1: Enable Primary volt. and secondary volt. can be set.
7	Over Voltage	(0~200)%	120%	Setting value is mains rated voltage's percentage, and return value (default: 116%) and delay value (default: 5s) can be set.
8	Under Voltage	(0~200)%	80%	Setting value is mains rated voltage's percentage, and return value (default: 84%) and delay value (default: 5s) can be set.
9	Over Frequency	(0~200)%	114%	Setting value is mains rated frequency's percentage, return value (default: 110%) and delay value (default: 5s) can be set.
10	Under Frequency	(0~200)%	90%	Setting value is mains rated frequency's percentage, return value (default: 94%) and delay value (default: 5s) can be set.
11	Current Trans.	(5-12000)/5	500	The ratio of external CT
12	Mains Rated (kW)	(1-60000)kW	345	Mains' active power, used for load distributes.
13	Mains Rated (kVar)	(1-60000)kVar	258	Mains' reactive power, used for load distributes.
14	Output Power Limit Alarm (PC)	(0-200)%	85%	When the controller detects that the mains power has exceeded the pre-set value, the corresponding alarm according to preset will be initiated.
15	Output Power Limit Action (PC)	(0-2)	0	
16	Mains Over Current 1 (PC)	(0-2)	0	Action Type 0: Warn 1: Mains Trip 2: No Action
		(0-12000)	500	Setting value.

No.	Items	Parameters	Defaults	Description
		(0-12000)	480	Return value.
		(0.0-3600.0)	30.0	Delay value.
17	Mains Over Current 2 (PC)	(0-2)	0	Action Type 0: Warn 1: Mains Trip 2: No Action
		(0-12000)	600	Setting value.
		(0-12000)	580	Return value.
		(0.0-3600.0)	1.0	Delay value.
Mains Split Setting (PC)				
1	Alarm Action	(0-1)	0	0: Trip and Stop; 1: Auxiliary mains fail If Auxiliary Mains Fail is selected, when alarm occurs, mains breaker will open and warning alarm will be initiated.
2	Over Voltage	(0-200)%	105%	Setting value is mains rated voltage's percentage, action (default: trip and stop) and delay value (default: 0.1s) can be set.
3	Under Voltage	(0-200)%	95%	
4	Over Frequency	(0-200)%	105%	
5	Under Frequency	(0-200)%	95%	Setting value is mains rated frequency's percentage, action (default: trip and stop) and delay value (default: 0.1s) can be set.
6	ROCOF	(0-1.00)Hz/s	0.20	Setting value is rate of change of frequency (ROCOF), action (default: trip and stop) and delay value (default: 0.1s) can be set.
7	Vector Shift	(0-20.0)°	6.0	Setting value is the change value of voltage waveform, action (default: trip and stop) and delay value (default: 0.1s) can be set.
Timer Setting				
1	Start Delay	(0~3600)s	5	Time from mains abnormal or remote start signal is active to start genset.
2	Stop Delay	(0~3600)s	30	Time from mains normal or remote start signal is inactive to stop genset.
Battery Setting				
1	Rated Voltage	(0-60.0)V	24.0	Standard for checking battery over/under voltage.
2	Over Voltage	(0-200)%	120%	Setting value is mains rated voltage's percentage, return value (default: 115%) and delay value (default: 60s) can be set.
3	Under Voltage	(0-200)%	85%	Setting value is mains rated voltage's percentage, return value (default: 90%) and delay value (default: 60s) can be set.
Bus Setting				
1	AC System	(0~3)	0	0: 3P4W; 1: 3P3W; 2: 2P3W; 3: 1P2W.
2	Rated Voltage	(30~30000)V	230	To offer standards for detecting of bus' over/under voltage. (It is primary voltage when using voltage transformer; it is line voltage when AC system is 3P3W while it is phase voltage when using other AC system).

No.	Items	Parameters	Defaults	Description
3	Rated Frequency	(10.0~600.0) Hz	50.0	To offer standards for detecting of over/under frequency.
4	Volt. Trans.(PT)	(0~1)	0	0: Disable; 1:Enable The primary secondary voltages can be set.
5	Bus Rated (kW)	(1~20000)kW	276	Bus' active power, used for load distributes.
6	Bus Rated (kVar)	(1~20000)kvar	210	Bus' reactive power, used for load distributes.
7	Load Ramp Rate	(0.1~100.0)%	3.0	Speed rate(%/s) of genset upload/unload
8	Load Ramp Point	(0.1~40.0)%	10.0	Each "Load Ramp Point" unit value increases, the load will added after "Load Ramp Delay".
9	Load Ramp Delay	(0~30)s	0	
10	Load CT Enable	(0~1)	0	
11	Load CT	(5~12000)/5	500	The ratio of external CT.
12	Insufficient Capacity Delay (PC)	(0~1800)s	20	When the controller detects that the bus power percentage has exceeded 100%, after the "Insufficient Capacity Delay", it will initiate a corresponding alarm according to the preset value. Action: 0: Warn 1: Trip 2: Trip and Stop
13	Insufficient Capacity Action (PC)	(0~2)	0	
Switch Setting				
1	Close Time	(0~20.0)s	5.0	Pulse width of switch on. When it is 0, means output constantly.
2	Open Time	(0~20.0)s	3.0	Pulse width of switch off.
3	Mains Failure Trip (PC)	(0~1)	0	0: Disable; 1:Enable
4	Stop Mode MB Control	(0~1)	1	0: Disable; 1:Enable
Switch Input Port Setting				
Input Port 1				
1	Function Selection	(0~55)	31	Remote start (demand). See Table 14.
2	Active Type	(0~1)	0	0: Closed to active 1: Open to active
Input Port 2				
1	Function Selection	(0~55)	0	User defined. See Table 14.
2	Active Type	(0~1)	0	0: Closed to active 1: Open to active
3	Arming	(0~2)	2	0: From paralleling 1: Always 2:Never
4	Active Actions	(0~4)	3	0: Warn; 1:Trip and stop 2:Trip 3: Indication 4: Mains Trip.
5	Active Delay	(0~20.0)s	2.0	Time from detecting active to confirm
6	Description			LCD display detailed contents when the input is active.
Input Port 3				
1	Function Selection	(0~55)	0	User defined. See Table 14.
2	Active Type	(0~1)	0	0: Closed to active 1: Open to active
3	Arming	(0~2)	2	0: From paralleling 1: Always 2:Never

No.	Items	Parameters	Defaults	Description
4	Active Actions	(0~4)	3	0: Warn; 1: Trip and stop 2: Trip 3: Indication 4: Mains Trip.
5	Active Delay	(0~20.0)s	2.0	Time from detecting active to confirm
6	Description			LCD display detailed contents when the input is active.
Input Port 4				
1	Function Selection	(0~55)	13	Bus Closed. See Table 14.
2	Active Type	(0~1)	0	0: Closed to active 1: Open to active
Input Port 5				
1	Function Selection	(0~55)	0	User defined. See form 3
2	Active Type	(0~1)	0	0: Closed to active 1: Open to active
3	Arming	(0~2)	2	0: From paralleling 1: Always 2: Never
4	Active Actions	(0~4)	3	0: Warn; 1: Trip and stop 2: Trip 3: Indication 4: Mains Trip.
5	Active Delay	(0~20.0)s	2.0	Time from detecting active to confirm
6	Description			LCD display detailed contents when the input is active.
Input Port 6				
1	Function Selection	(0~55)	0	User defined. See Table 14.
2	Active Type	(0~1)	0	0: Closed to active 1: Open to active
3	Arming	(0~2)	2	0: From paralleling 1: Always 2: Never
4	Active Actions	(0~4)	3	0: Warn; 1: Trip and stop 2: Trip 3: Indication 4: Mains Trip.
5	Active Delay	(0~20.0)s	2.0	Time from detecting active to confirm
6	Description			LCD display detailed contents when the input is active.
Input Port 7				
1	Function Selection	(0~55)	0	User defined. See Table 14.
2	Active Type	(0~1)	0	0: Closed to active 1: Open to active
3	Arming	(0~2)	2	0: From paralleling 1: Always 2: Never
4	Active Actions	(0~4)	3	0: Warn; 1: Trip and stop 2: Trip 3: Indication 4: Mains Trip.
5	Active Delay	(0~20.0)s	2.0	Time from detecting active to confirm
6	Description			LCD display detailed contents when the input is active.
Input Port 8				
1	Function Selection	(0~55)	15	Mains Closed. See Table 14.
2	Active Type	(0~1)	0	0: Closed to active 1: Open to active
Output Ports Setting				

No.	Items	Parameters	Defaults	Description
Output Port 1				
1	Function Selection	(0~239)	44	Bus OK. See Table 13.
2	Active Type	(0~1)	0	0: Normally open; 1: Normally close
Output Port 2				
1	Function Selection	(0~239)	48	Common Alarm. See Table 13.
2	Active Type	(0~1)	0	0: Normally open; 1: Normally close
Output Port 3				
1	Function Selection	(0~239)	46	Mains OK. See Table 13.
2	Active Type	(0~1)	0	0: Normally open; : Normally close
Output Port 4				
1	Function Selection	(0~239)	47	Synchronizing See Table 13.
2	Active Type	(0~1)	0	0: Normally open; 1: Normally close
Output Port 5				
1	Function Selection	(0~239)	31	Close Mains Output. See Table 13.
2	Active Type	(0~1)	0	0: Normally open; : Normally close
Output Port 6				
1	Function Selection	(0~239)	29	Close Bus Output. See Table 13.
2	Active Type	(0~1)	0	0: Normally open; 1: Normally close
Output Port 7				
1	Function Selection	(0~239)	32	Open Mains Output. See Table 13.
2	Active Type	(0~1)	0	0: Normally open; 1:Normally close
Output Port 8				
1	Function Selection	(0~239)	30	Open Bus Output. See Table 13.
2	Active Type	(0~1)	0	0: Normally open; 1: Normally close
Module Setting				
1	Power On Mode	(0~2)	0	0: Stop mode 1: Manual mode 2: Auto mode
2	Comm. Address	(1~254)	1	Controller's address during remote sensing.
3	Language	(0~2)	0	0: Simplified Chinese 1: English 2: Others
4	Password	(0~65535)	00318	For entering advanced parameters setting.
5	Date & Time			Format: YYYY.mm.dd HH:MM:SS.
6	Stop Bit	(0~1)	0	0: 2 stop bits; 1: 1 stop bit
Scheduled Run				
1	Enable Setting	(0~1)	0	0: Disable; 1: Enable
2	Load Setting	(0~1)	0	0: Disable; 1: Enable
3	Cycle Selection	(0-3)	0	0: Monthly 1: Weekly 2: Daily 4: Custom Weekly.

No.	Items	Parameters	Defaults	Description
4	Start Time (Week)	(0-6)	0	0~6 correspond to Sun.~Mon.
5	Start Time (Day)	(1~31)	1	1~31 correspond to 1 st ~31 st .
6	Start Time (Hour)	(0~23)	0	0~23 correspond to 0~23'o clock.
7	Start Time (Minute)	(0~59)	0	0~59 correspond to 0~59 minutes.
8	Total Running Time	(0~30000)	30	Scheduled running time, unit: min.
9	Custom Setting Weekly	(0~6)	0	1: Start Time (Day)1: Start Time (Hour) 1: Start Time (Minute)1: Total Running time to 16: Start Time (Day)16: Start Time (Hour) 16: Start Time (Minute)16: Total Running time
Sync Setting -Basic				
1	MSC ID	(0-31)	1	It is the ID mark of the MSC communication internet. All the MSC ID should be unique.
2	MSC Priority	(0-31)	0	Smaller values represent higher priorities.
3	Sync Freq. Gain	(0-500)	20	Adjust and control before paralleling.
4	Sync Freq. Stability	(0-2000)	20	Adjust and control before paralleling.
5	Sync Volt. Gain	(0-500)	20	Adjust and control after paralleling.
6	Sync Volt. Stability	(0-2000)	20	Adjust and control after paralleling.
7	kW Control Gain	(0-500)	20	Adjust and control before paralleling.
8	kW Control Stability	(0-2000)	20	Adjust and control before paralleling.
9	kvar Control Gain	(0-500)	20	Adjust and control before paralleling.
10	kvar Control Stability	(0-2000)	20	Adjust and control before paralleling.
11	Dead Bus Volt	(10-50)V	30	It is considered Bus no power when Bus voltage is lower than dead Bus voltage.
12	Slip Frequency	(0-1.00)Hz	0.10	Adjust bus frequency and enable it greater than mains frequency. When slip frequency is 0: If the frequency difference is greater than 0.1Hz, then the frequency will be synchronized; If the frequency difference is smaller than 0.1Hz, then the phase will be synchronized;
13	Voltage Difference	(0-30)V	3	The voltage difference between bus and mains. It is considered voltage synchronization when the voltage difference between mains and Bus is lower than synchronization voltage difference.
14	Positive Difference Freq	(0-2.0)Hz	0.2	The frequency difference between bus and mains. It is considered frequency synchronization when the frequency difference between mains and Bus is less than Positive Freq Difference but more than Negative Freq Difference.
15	Negative Difference Freq	(0-2.0)Hz	0.1	
16	Phase Difference Angle	(0-20)°	10	Initial phase difference between bus and mains. It is considered Check Phase Angle when the initial phase difference is lower

No.	Items	Parameters	Defaults	Description
				than synchronization phase difference.
17	Fail to Sync Delay	(5.0-300.0)s	60.0	When the controller detects no Sync signal during the preset delay, it will send corresponding alarm signal according to the action type. Action Type: 0: Warn; 1: Trip.
18	Fail to Sync Action	(0-1)	0	
19	MSC Number	(1-32)	2	
20	Comm. Alarm Action	(0~2)	1	Action 0: None 1: Warn 2: Trip
21	Comm. Ratio	(0~3)	1	0: 500KBit/s; 1: 250KBit/s; 2: 125KBit/s; 3: 50KBit/s.
22	Scheduled Run PCT	(0-100)%	80	Schedule the load value of other genset when start on demand.
23	Scheduled Stop PCT	(0-100)%	50	Schedule the load value of other genset when start on demand.
24	Load Mode	(0-2)	0	0: Bus Control; 1: Mains Control; 2: Load Control.
25	Output (kW)	(0-100.0)%	30.0	Used for load control.
26	Output (kVar)	(0-100.0)%	8.0	Used for load control.
27	Min Start Sets	(1-32)	1	When the controller does not detect the Min Start Sets during the preset delay, it will send corresponding alarm signal according to the action type. Action Type: 0: No Action; 1: Warn; 2: Trip.
28	Not Reached Act	(0-2)	1	
29	Request Start Delay	(0-3600)s	120	
30	MSC Transformer	(0~1)	0	0: Disable; 1: Enable
Scheduled Not Run				
1	Enable Setting	(0~1)	0	0: Disable; 1: Enable
2	Cycle Selection	(0~2)	0	0: Monthly 1: Weekly 2: Daily
3	Not Start Time (Week)	(0~6)	0	0~6 correspond to Sun.~Mon.
4	Not Start Time (Day)	(1~31)	1	1~31 correspond to 1 st ~31 st .
5	Not Start Time (Hour)	(0~23)	0	0~23 correspond to 0~23'o clock.
6	Not Start Time (Minute)	(0~59)	0	0~59 correspond to 0~59 minutes.
7	Total Time	(0~30000)	30	Not scheduled running time, unit: min.
Maintenance Setting				
1	Enable Setting	(0~1)	0	0: Disable; 1: Enable
2	Time Setting (PC)	(0~5000)	30	Maintenance time setting.
3	Maintenance Time Due Action	(0~2)	0	0: Warn 1: Trip 2: Trip and stop

8.2 ENABLE DEFINITION OF PROGRAMMABLE OUTPUT PORTS

Table 13 Definable Contents of Programmable Output Ports

No.	Type	Description
0	Not Used	
1~6	Reserved	
7	Custom Combined 1	Details of function description please see the following.
8	Custom Combined 2	
9	Custom Combined 3	
10	Custom Combined 4	
11	Custom Combined 5	
12	Custom Combined 6	
13~17	Reserved	
18	Audible Alarm	Action when warning, shutdown, trips. Can be connected annunciator externally. When "alarm mute" configurable input port is active, it can remove the alarm.
19~25	Reserved	
26	Remote Control Output	This port is controlled by communication (PC).
27~28	Reserved	
29	Close Bus Output	Control bus to take load.
30	Open Bus Output	Control bus to off load.
31	Close Mains Output	Control mains to take load.
32	Open Mains Output	Control mains to off load.
33~43	Reserved	
44	Bus OK	Action when bus is normal.
45	Reserved	
46	Mains OK	Action when mains is normal.
47	Synchronizing	Action when controller is synchronizing.
48	Common Alarm	Action when genset common warning, common shutdown, common trips alarm.
49	Common Trip and Stop	Action when common trip and stop alarm.
50	Common Shutdown	Action when common shutdown alarm.
51	Common Trip	Action when common trips alarm.
52	Common Warn	Action when common warning alarm.
53	Reserved	
54	Battery Over Voltage	Action when battery's over voltage warning alarm.
55	Battery Under Voltage	Action when battery's low voltage warning alarm.
56~68	Reserved	
69	Digital Input 1 Active	Action when input port 1 is active
70	Digital Input 2 Active	Action when input port 2 is active
71	Digital Input 3 Active	Action when input port 3 is active
72	Digital Input 4 Active	Action when input port 4 is active
73	Digital Input 5 Active	Action when input port 5 is active
74	Digital Input 6 Active	Action when input port 6 is active
75	Digital Input 7 Active	Action when input port 7 is active
76	Digital Input 8 Active	Action when input port 8 is active

No.	Type	Description
77~124	Reserved	
125	Mains Inactive	
126	Mains Over Freq	
127	Mains Over Volt	
128	Mains Under Freq	
129	Mains Under Volt	
130	Phase Sequence Wrong	
131	Mains Loss of Phase	
132	Mains Freq. Change	
133	Mains Vector Offset	
134	Mains Over Current	
135~229	Reserved	
230	Stop Mode	Action in stop mode.
231	Manual Mode	Action in Manual mode.
232	Reserved	Reserved.
233	Auto Mode	Action in Auto mode.
234	Generator Load	
235	Mains Load	
236~239	Reserved	

8.2.1 DEFINED COMBINATION OUTPUT

Defined combination output is composed by 3 parts, condition output S1 or S2 and condition output S3.

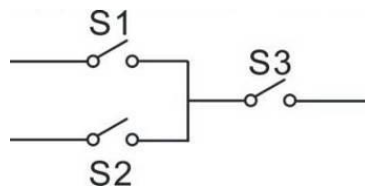

S1 or S2 is **TRUE**, while S3 is **TRUE**, Defined combination output is outputting;

S1 and S2 are **FALSE**, or S3 is **FALSE**, Defined combination output is not outputting.

NOTE: S1, S2, S3 can be set as any contents except for "defined combination output" in the output setting.

NOTE: 3 parts of defined combination output (S1, S2, S3) couldn't include or recursively include themselves.

Example,

Contents of probably condition output S1: output port 1 is active;

Close when probably condition output S1 is active /inactive: close when active (disconnect when inactive);

Contents of probably condition output S2, output port 2 is active;

Close when probably condition output S2 is active /inactive: close when active (disconnect when inactive);

Contents of probably condition output S3: output port 3 is active;

Close when probably condition output S3 is active /inactive: close when active (disconnect when inactive);



When input port 1 active or input port 2 active, if input port 3 is active, Defined combination output is outputting;

If input port 3 inactive, Defined combination output is not outputting;

When input port 1 inactive and input port 2 inactive, whatever input port 3 is active or not, Defined combination output is not outputting.

8.3 DEFINED CONTENTS OF DIGITAL INPUT PORTS (ALL ACTIVE WHEN CONNECT TO GROUND (B~))

Table 14 Definable Contents of Digital Input Ports

No.	Type	Description
0	Users Configured	Including following functions, Indication: indicate only, not warning or shutdown. Warning: warn only, not shutdown. Trip and stop: alarm, generator unloads and shutdown after hi-speed cooling Trip: alarm, generator unloads but not shutdown. Mains Trip: alarm, mains opening outputs. Never: input inactive. Always: input is active all the time. From paralleling: detect when the genset is parallel running.
1	Mains Switch Control Unavailable	The status of mains switch is judged by mains status. If mains power is normal, the switch status is closed; while if mains power is abnormal, the switch status is open.
2	Alarm Mute	Can prohibit "Audible Alarm" output when input is active.
3	Reset Alarm	Can reset shutdown alarm and trip alarm when input is active.
4	Reserved	
5	Lamp Test	All LED indicators are illuminating when input is active.
6	Panel Lock	All buttons in panel is inactive except  and there is  in the right of first row in LCD when input is active.
7~8	Reserved	
9	Inhibit Auto Stop	In Auto mode, during generator normal running, when input is active, prohibit generator shutdown automatically.
10	Inhibit Auto Start	In Auto mode, prohibit generator start automatically when input is active.
11	Inhibit Scheduled Start	In Auto mode, prohibit fixed timing start genset when input is active.
12	Mains Switch Control Unavailable Feedback	The status of mains switch is judged by mains status and mains closed status. If mains power is normal and mains closed status is active; the switch status is closed; otherwise, the switch status is open.
13	Aux Bus Closed	Connect bus loading switch's Aux. Point.
14	Inhibit Bus Load	Prohibit bus switch on when input is active.
15	Aux Mains Closed	Connect mains loading switch's Aux. Point.
16	Inhibit Mains Load	Prohibit mains switch on when input is active.
17	Auto Mode Lock	When input is active, controller enters into Auto mode; all the keys except  are inactive.
18	Auto Mode Invalid	When input is active, controller won't work under Auto mode.

No.	Type	Description
		 key and simulate auto key input does not work.
19	Reserved	
20	Reserved	
21	Inhibit Alarm Stop	All shutdown alarms are prohibited except emergency stop.(Means battle mode)
22	Aux Instrument Mode	All outputs are prohibited in this mode.
23	Reserved	
24	Reset Maintenance	Controller will set maintenance time and date as default when input is active.
25~27	Reserved	
28	Remote Start (On Load)	In Auto mode, when the input is active, genset can be started and with load after genset is OK; when the input is inactive, genset will stop automatically.
29	Remote Start (Off Load)	In Auto mode, when the input is active, genset can be started and without load after genset is OK; when the input is inactive, genset will stop automatically.
30	Aux. Manual Start	In Auto mode, when the input is active, genset will start automatically; when the input is inactive, genset will stop automatically
31	Remote Start (On Demand)	In Auto mode, when the input is active, all genset that need to be parallel will start according to the priority and calling other generator according to the load.
32	Remote Start (Island)	In Auto mode, when the input is active, genset will start automatically; genset will take load when it is normal running while mains off load. when the input is inactive, mains will take load while genset off load and stop automatically.
33	Simulate Stop key	An external button (not self-locking) can be connected and pressed as simulate panel.
34	Simulate Manual key	
35	Reserved	
36	Simulate Auto key	An external button (not self-locking) can be connected and pressed as simulate panel.
37	Simulate Start key	
38	Simulate B-Load key	
39	Simulate M-Load key	
40	10s Detecting Mains	When input is active, detecting mains normal or abnormal delay changes to 10s.
41~44	Reserved	
45	Simulate Mains Normal	In Auto mode, when the input is active, mains is normal.
46	Simulate Mains Abnormal	In Auto mode, when the input is active, mains is abnormal.
47	Alternative Config 1	Users can set different parameters to make it easy to select current configuration via input port.
48	Alternative Config 2	
49	Alternative Config 3	
50	Reserved	
51	Speed-up Input	Load mode selection is Bus Control mode. When input port is active, the active power of generation side is increased.
52	Speed-down Input	Load mode selection is Bus Control mode. When input port is

No.	Type	Description
		active, the active power of generation side is decreased.
53	Step-up Output	Load mode selection is Bus Control mode. When input port is active, the reactive power of generation side is increased.
54	Step-down Output	Load mode selection is Bus Control mode. When input port is active, the reactive power of generation side is decreased.
55	Reserved	

9 PARAMETERS SETTING

⚠ CAUTION: Please change the controller parameters when generator is in standby mode only (e. g. configurable input, configurable output, various delay), otherwise, alarming to stop and other abnormal conditions may happen.

⚠ NOTE: Maximum set value must over minimum set value in case that the condition of too high as well as too low will happen.

⚠ NOTE: When setting the warning alarm, please set the correct return value; otherwise, maybe there is abnormal alarm. When setting the maximum value, the return value must less than setting; when setting the minimum value, the return value must over setting.

⚠ NOTE: Configurable input could not be set as same items; otherwise, there are abnormal functions. However, the configurable output can be set as same items.

10 COMMISSIONING

- 1) Start the genset, perform on-load test and then stop the genset respectively.
- 2) Close the genset switch, parallel the genset to Bus and then open the genset switch respectively.
- 3) Set each genset (e.g. HGM9510) as auto mode.
- 4) Set the HGM9560 controller as manual mode, when the mains is normal, perform mains switch close/open test and check if the mains switch is normal; then open the mains switch if it is ok.
- 5) Start the HGM9560 controller manually, when the bus is normal, perform bus switch close/open test and check if the bus switch is normal; then open the bus switch if it is ok.
- 6) Press the mains close button, the bus will anti-synchronize to mains; then mains close after the synchronization is successful and parallel running is beginning.
- 7) Perform on-load test and load transfer test.
- 8) Set the HGM9560 controller as manual mode, the controller will control the genset to start/stop and share load automatically according to the preset condition.

11.1 BUS CONTROL MODE

Output preset active power, reactive power and power factor.

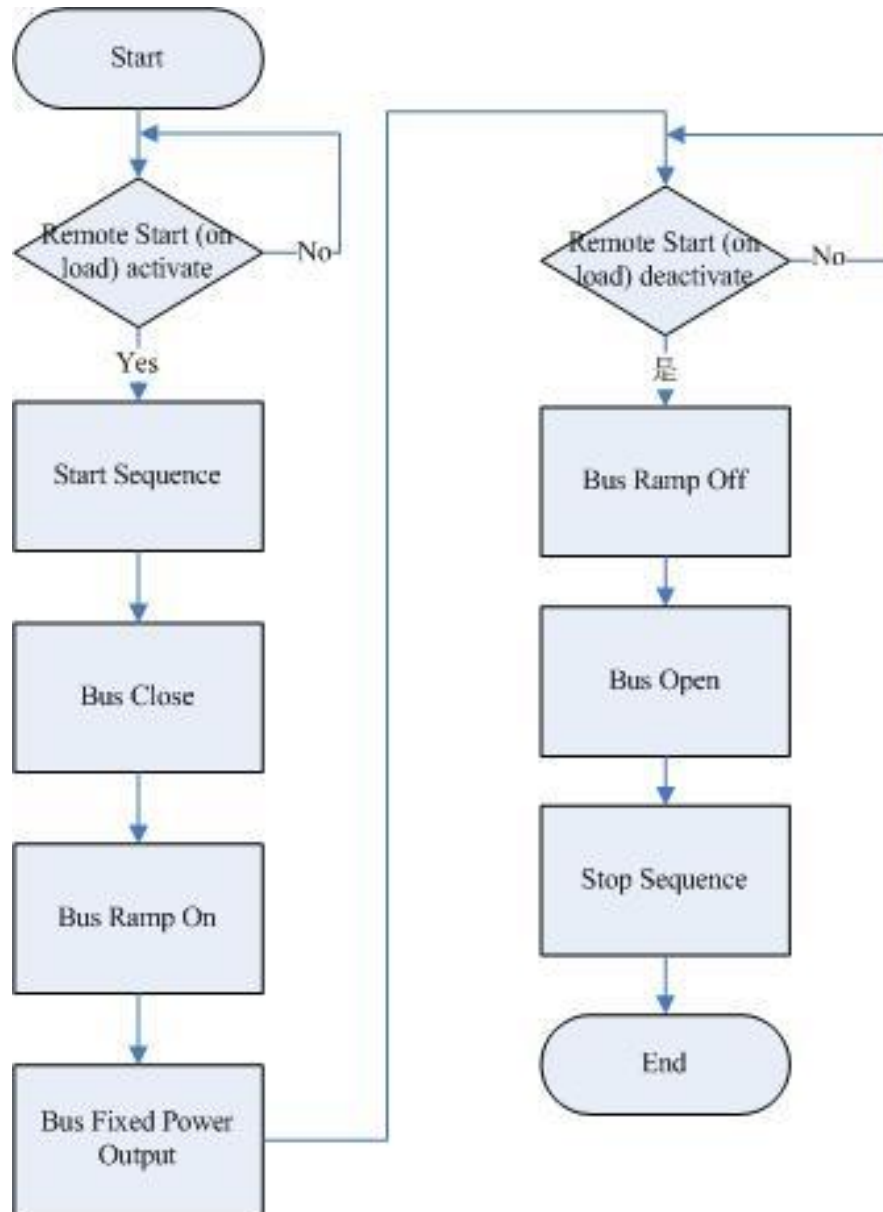

Fig.3 Bus Control Mode

11.2 MAINS CONTROL MODE

If the power value is set as a positive number, when the mains input increases above the power setpoint, the generator bus will supply the extra load in order to maintain the mains input at the predefined level (mains peak lopping mode).

If the power value is set as a negative number, the generator bus will supply the preset power to mains. The total output power of the generator bus is the sum of the consumption power and the preset power which supplied by generator bus to mains.

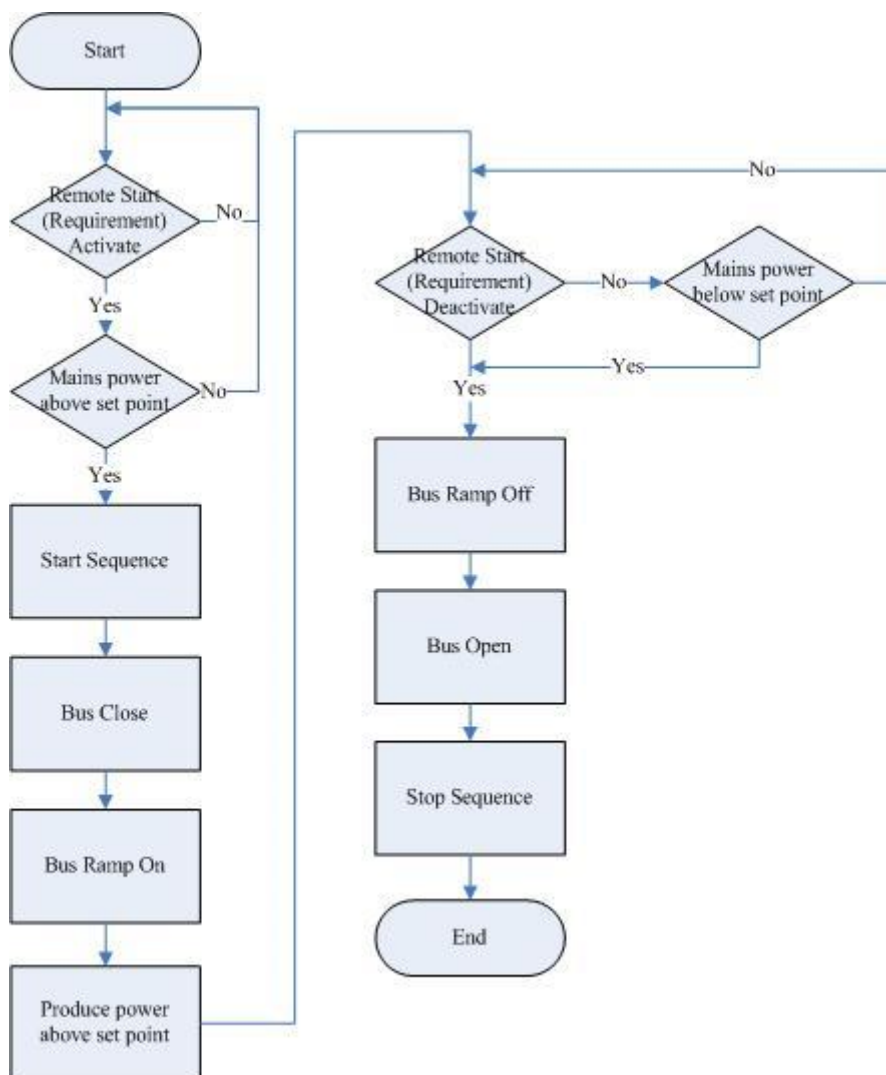

Fig.4 Mains Peak Lopping Mode

11.3 LOAD TAKEOVER MODE

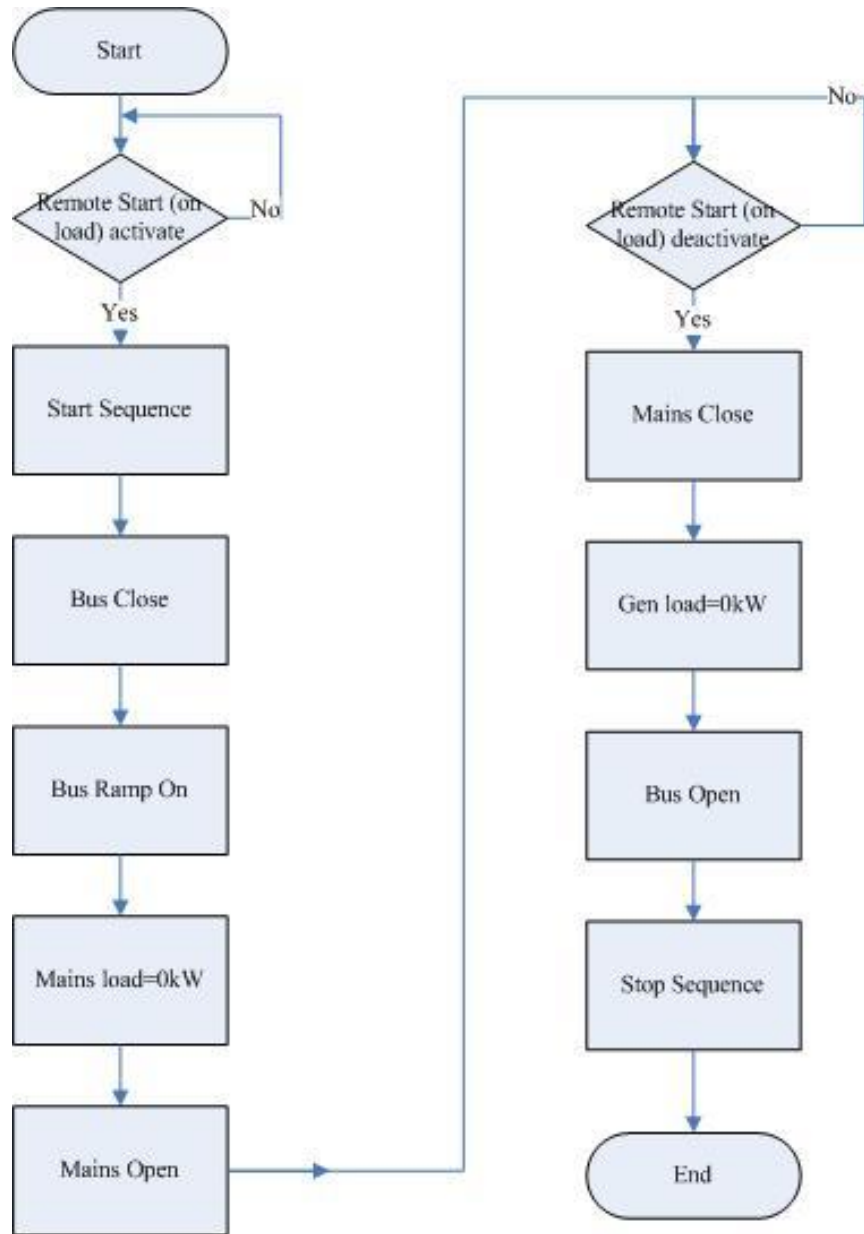

Fig.5 Load Takeover Mode

11.4 AMF MODE

Automatic mains failure mode. No-break return to mains supply.

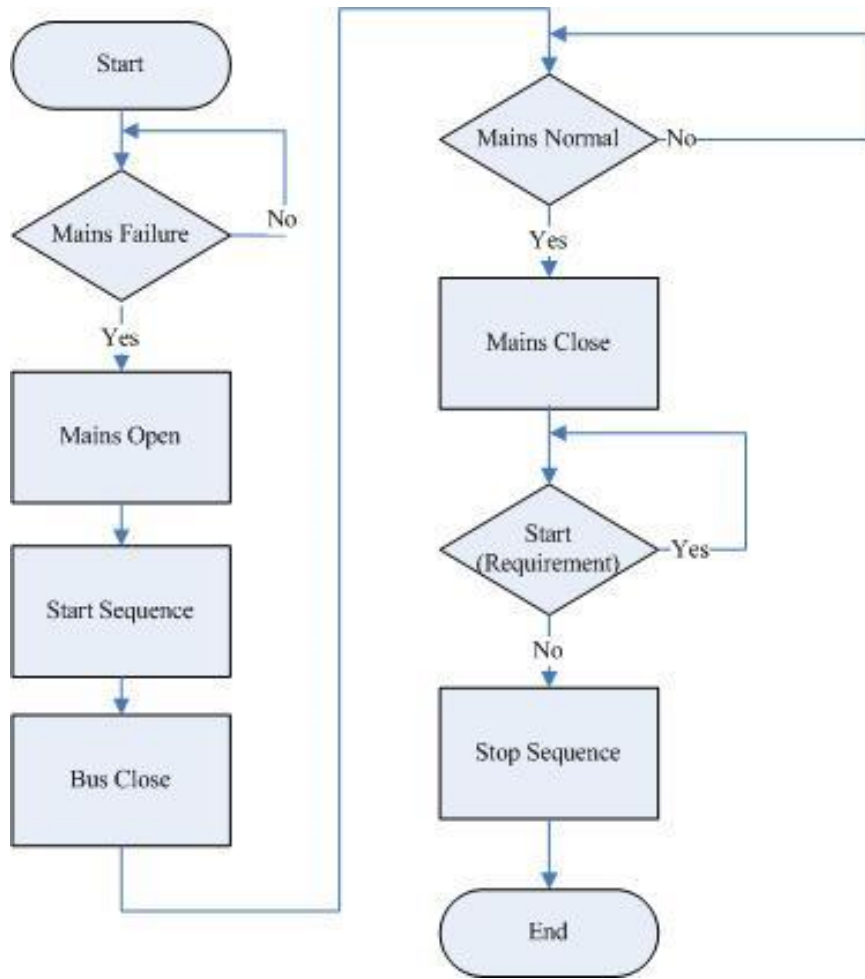

Fig.6 AMF Mode

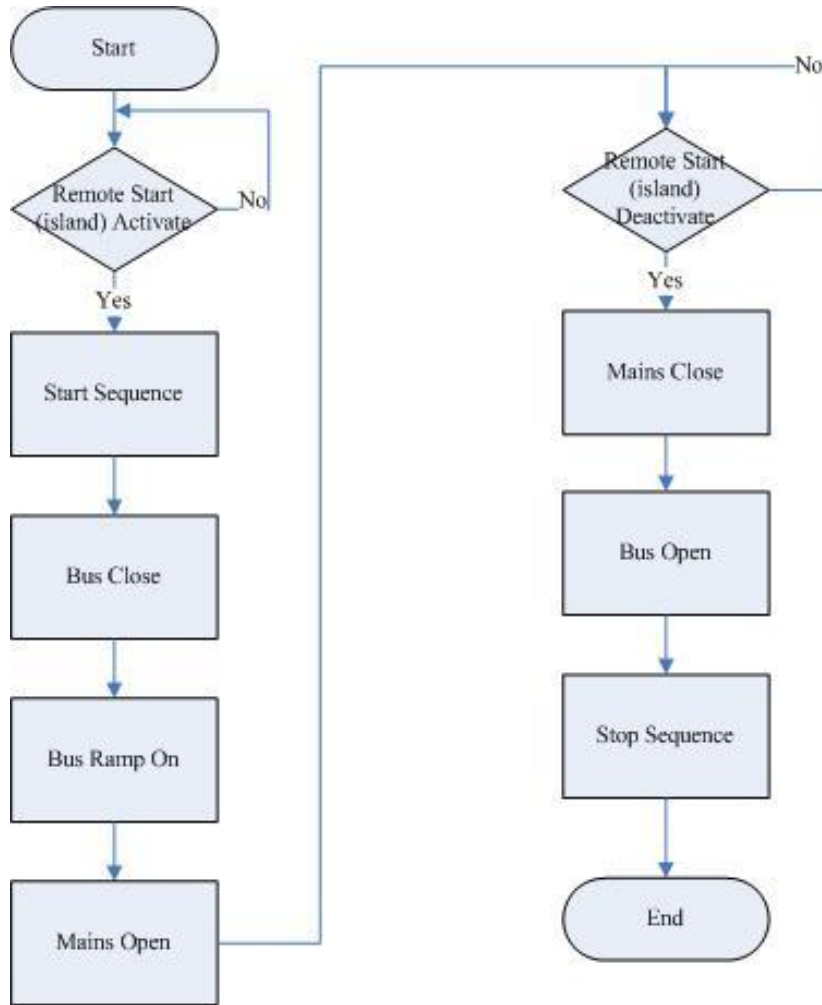

Fig.7 Island Mode

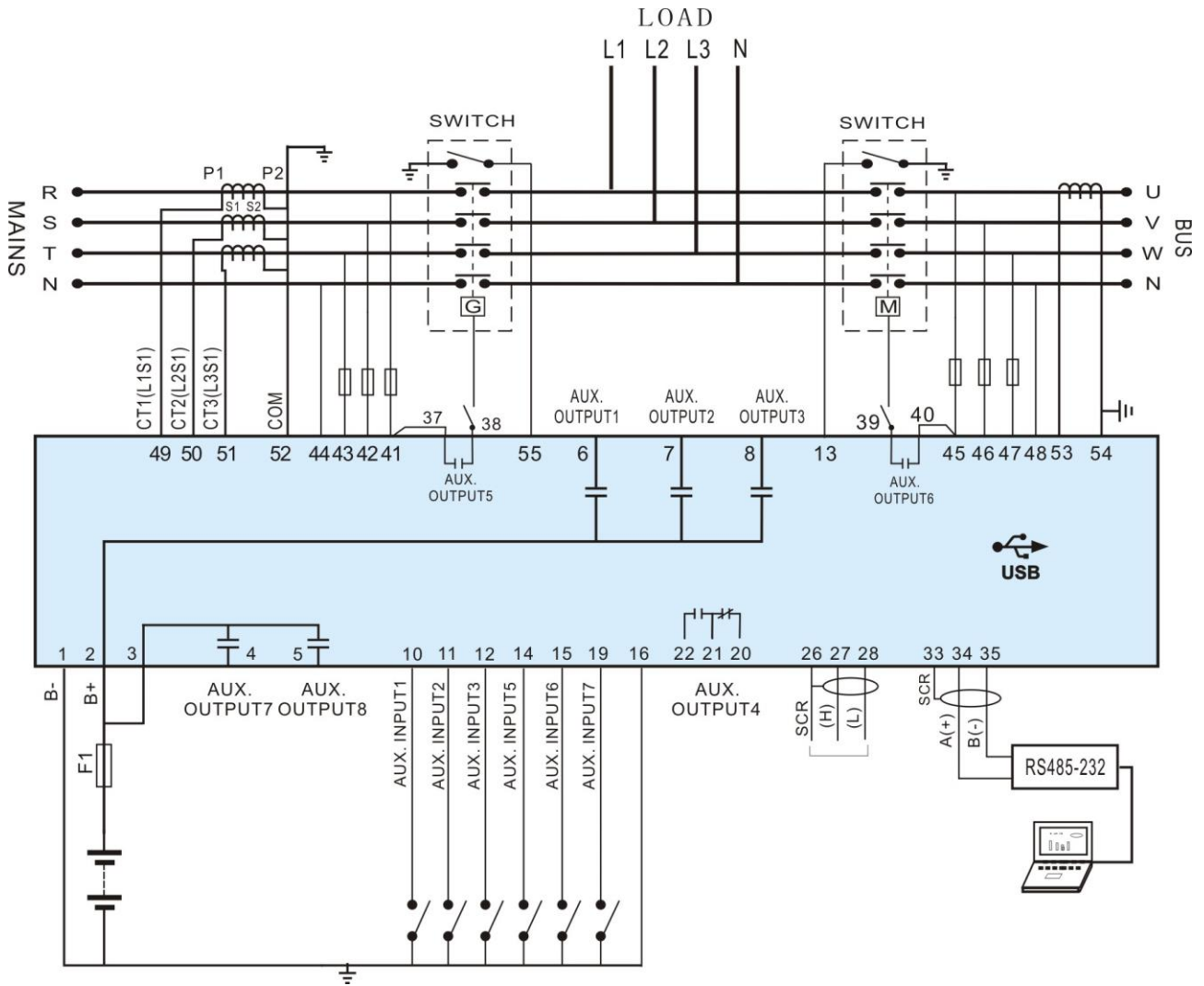

Fig.8 HGM9560 Typical Diagram

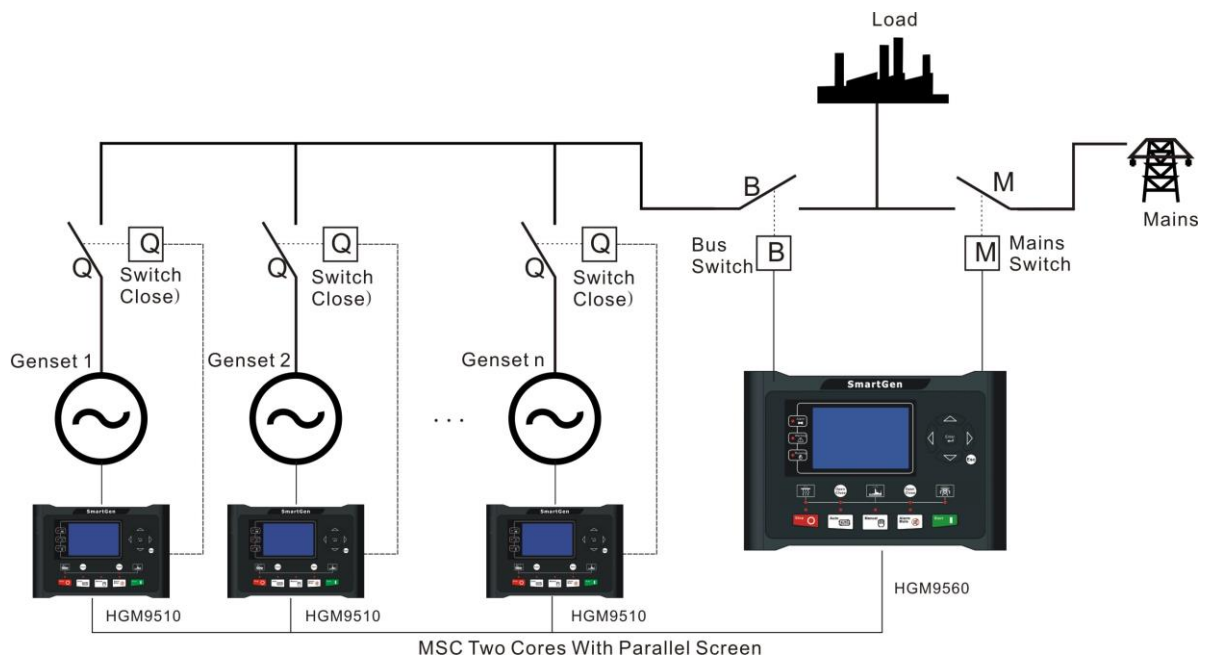

Fig.9 Single Set Communication

Note: Bus CT is a non-issue for single set communication and the bus power can be obtained from MSC communication; therefore, the users can disable it.

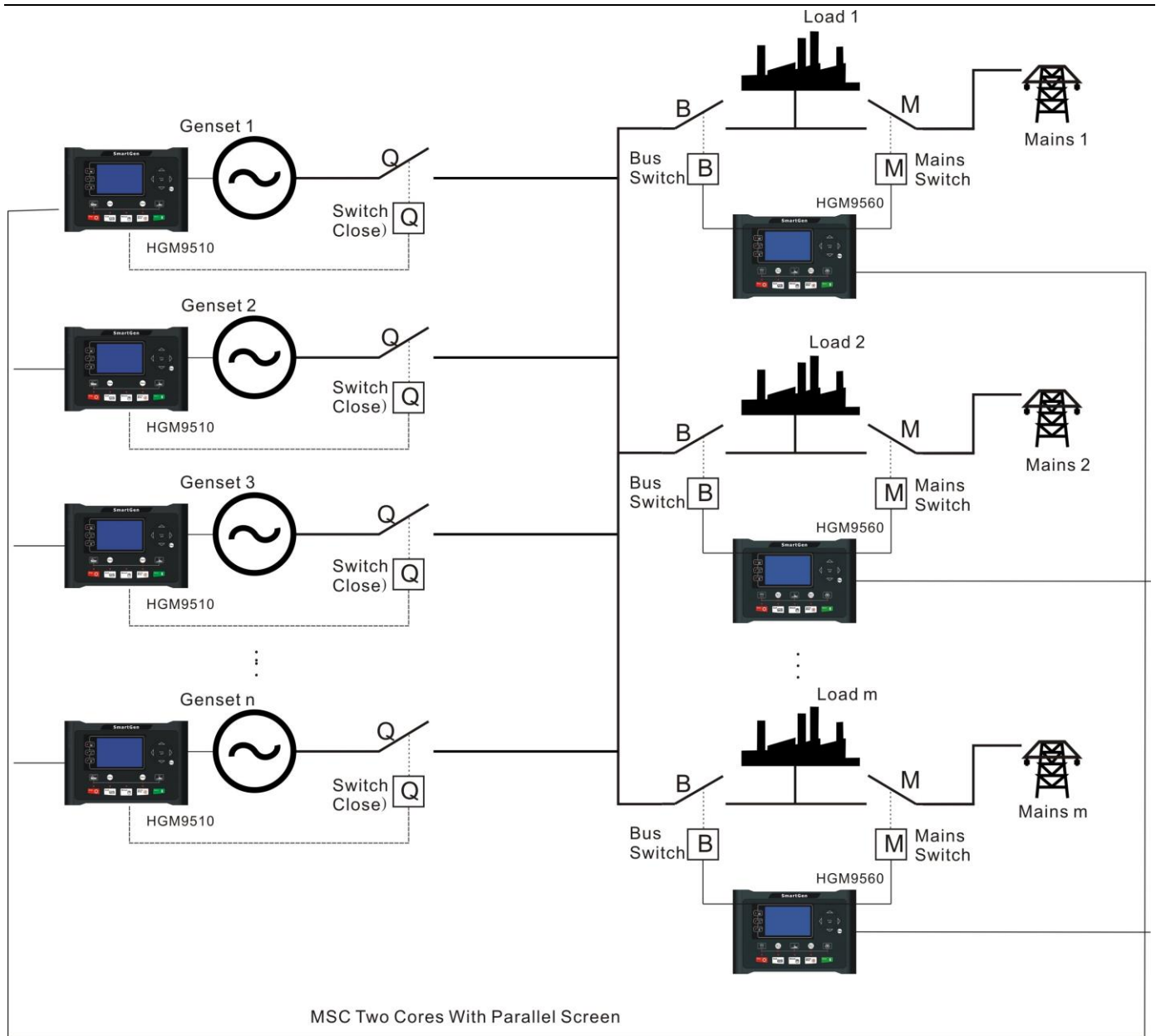

Fig.10 Multi Set Communication

Note: Bus CT is important for multi set communication, so make sure that it is soundly connected.

14 INSTALLATION

Controller is panel built-in design; it is fixed by clips when installed. The controller's overall dimensions and cutout dimensions for panel, please refers to as following:

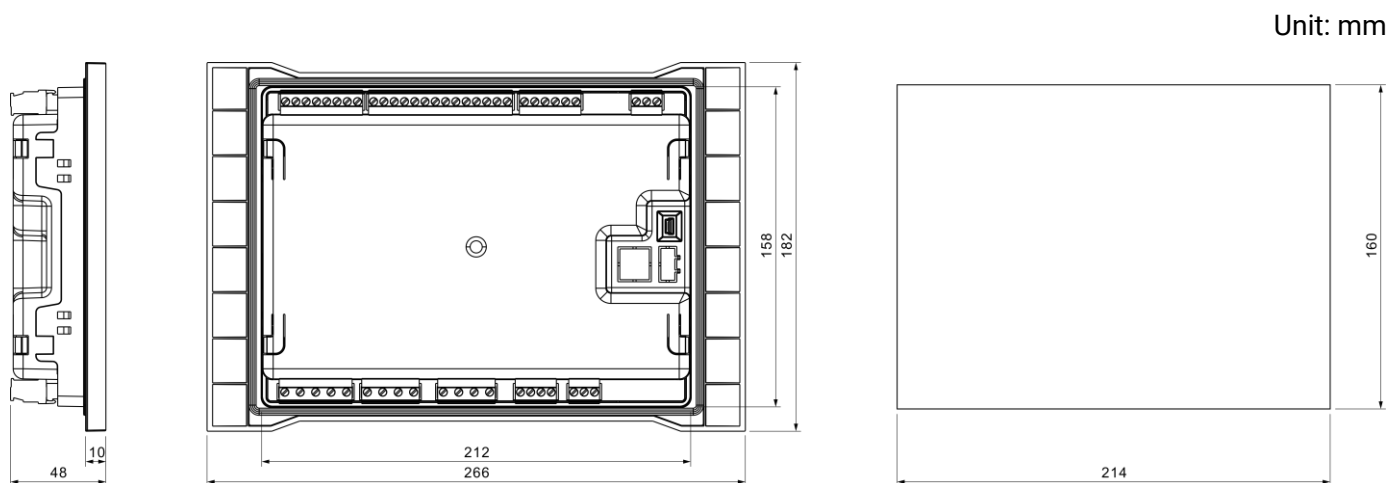

Fig.11 Case Dimensions and Panel Cutout

1) Battery Voltage Input

NOTE: HGM9560 controller can suit for widely range of battery voltage DC(8~35)V. Negative of battery must be connected with the engine shell. The diameter of wire which from power supply to battery must be over 2.5mm². If floating charge configured, please firstly connect output wires of charger to battery's positive and negative directly, then, connect wires from battery's positive and negative to controller's positive and negative input ports in order to prevent charge disturbing the controller's normal working.

2) Output And Expand Relays

CAUTION: All outputs of controller are relay contact output type. If need to expand the relays, please add freewheel diode to both ends of expand relay's coils (when coils of relay has DC current) or, add resistance-capacitance return circuit (when coils of relay has AC current), in order to prevent disturbance to controller or others equipment.

3) AC Input

Current input of HGM9560 controller must be connected to outside current transformer. And the current transformer's secondary side current must be 5A. At the same time, the phases of current transformer and input voltage must correct. Otherwise, the current of collecting and active power maybe not correct.

NOTE: ICOM port must be connected to negative pole of battery.

WARNING! When there is load current, transformer's secondary side prohibit open circuit.

4) Withstand Voltage Test

CAUTION! When controller had been installed in control panel, if need the high voltage test, please disconnect controller's all terminal connections, in order to prevent high voltage into controller and damage it.

15 USB

Users can set the controller's parameters and monitor the controller's status via the test software which provided by Smartgen company. The connection way between PC and controller as following:



Fig.12 USB Connection

Table 15 Fault Finding

Symptoms	Possible Solutions
Controller no response with power.	Check starting batteries; Check controller connection wirings; Check DC fuse.
Shutdown Alarm in running	Check related switch and its connections according to the information on LCD; Check programmable inputs.
Genset running while ATS not transfer	Check ATS; Check the connections between ATS and controllers.
RS485 communication is abnormal	Check connections; Check setting of COM port is correct or not; Check RS485's connections of A and B is reverse connect or not; Check RS485 transfer module whether damage or not; Check communication port of PC whether damage.