



SmartGen
ideas for power

HMP300

POWER INTEGRATED PROTECTION MODULE

USER MANUAL

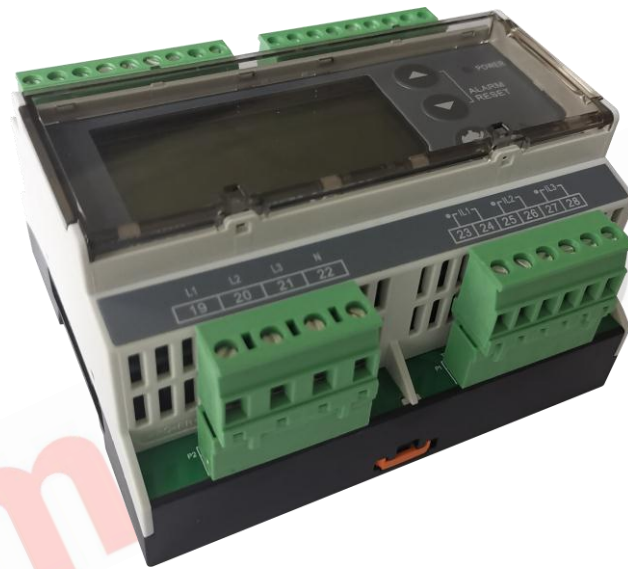

SMARTGEN (ZHENGZHOU) TECHNOLOGY CO., LTD.



Chinese trademark

SmartGen English trademark

SmartGen — make your generator *smart*

SmartGen Technology Co., Ltd.

No.28 Jinsuo Road

Zhengzhou City

Henan Province

P. R. China

Tel: 0086-(0)371-67988888/67981888

0086-(0)371-67991553/67992951

0086-(0)371-67981000(overseas)

Fax: 0086-(0)371-67992952

Web: www.smartgen.com.cn

www.smartgen.cn

Email: sales@smartgen.cn

All rights reserved. No part of this publication may be reproduced in any material form (including photocopying or storing in any medium by electronic means or other) without the written permission of the copyright holder.

Applications for the copyright holder's written permission to reproduce any part of this publication should be addressed to Smartgen Technology at the address above.

Any reference to trademarked product names used within this publication is owned by their respective companies.

SmartGen Technology reserves the right to change the contents of this document without prior notice.

Table 1 Software Version

Date	Version	Note
2019-07-24	1.0	Original release.
2019-08-27	2.0	Fixed the version number to 2.0
2020-05-22	2.1	Added custom protocol function description, fixed current trip to long delay trip and short delay trip;

CONTENTS

1 OVERVIEW	4
2 PERFORMANCE AND CHARACTERISTICS	5
3 SPECIFICATION OPERATION	6
4 OPERATION	7
5 SCREEN DISPLAY	8
5.1 POWER DATA DISPLAY	8
5.2 ALARM DISPLAY.....	8
5.3 MODULE INFORMATION DISPLAY	9
5.4 HARMONIC DATA DISPLAY	9
6 PROTECTION	10
6.1 WARNING.....	10
6.2 TRIP ALARM.....	12
7 WIRING CONNECTION	13
8 SCOPES AND DEFINITIONS OF PROGRAMMABLE PARAMETERS	15
8.1 CONTENTS AND SCOPES OF PARAMETERS.....	15
8.2 DEFINABLE CONTENTS OF PROGRAMMABLE OUTPUT PORTS 1~4.....	22
9 PARAMETERS SETTING.....	24
10 CUSTOM PROTOCOL FUNCTION.....	25
11 TYPICAL APPLICATION.....	26
12 INSTALLATION	27

1 OVERVIEW

HMP300 power Integrated protection module integrates digitization, intelligentization and network technology, which is used for collecting genset data (voltage, current, power and frequency) and outputting related actions if data errors occur, for the purpose of protecting the device. It fits with LCD display, optional Chinese and English language interface. It is reliable and easy to use.

HMP300 power integrated protection module adopts micro-processor technology, which makes it possible to precisely do parameter measuring, fixed value adjustment, set value adjusting etc. All parameters can be configured on front panel or through LINK interface via PC. It can be widely used for all types of marine/land power distribution devices with compact structure, simple wirings and high reliability.

SmartGen

2 PERFORMANCE AND CHARACTERISTICS

Main features are as follows:

- 132x64 LCD with backlight, selectable language interface (Chinese and English), push-button operation.
- RS485 communication port: through which data measuring and parameter setting can be done for the module on PC with software.
- Protections for over/under voltage, over/under frequency, reverse power, over power and over current.
- Current detection alarm makes it possible to do 3 times over current detection and corresponding alarms.
- With voltage harmonic test function, each phase voltage harmonic distortion rate and 3-31 times harmonic can be tested.
- With current harmonic test function, each phase current harmonic distortion rate and 3-31 times harmonic can be tested.
- Suitable for 3-phase 4-wire, 3-phase 3-wire, single phase 2-wire, and 2-phase 3-wire systems with frequency 50/60Hz;
- Collects and shows 3-phase voltage, 3-phase current, frequency and power parameters.

Generator

Line voltage (Uab, Ubc, and Uca)

Phase voltage (Ua, Ub, and Uc)

Frequency Hz

Load

Current Ia, Ib, Ic A (unit)

Each phase and total active power P kW (unit)

Each phase and total reactive power Q kvar (unit)

Each phase and average power factor PF

- Parameter setting function: parameters can be modified and stored in internal FLASH memory and cannot be lost even in case of power outage; all of them can be adjusted on front panel of the controller.
- Wide power supply range DC (8~35) V, which is suitable for different power voltage environments.
- All parameters apply digital adjustment, getting rid of conventional analog modulation with normal potentiometer, improving wholesome reliability and stability.
- Module is mounted with the 35mm guide rail.





3 SPECIFICATION OPERATION

Table 2 Technical Parameters

Items	Contents
Operating Voltage	DC8.0V to DC35.0V, Continuous Power Supply.
Power Consumption	<3W (standby ≤2W)
Alternator Volt Input Range	
3Phase 4Wire	30V AC ~ 360 V AC (ph-N)
3Phase 3Wire	30V AC ~ 620 V AC (ph-ph)
Single Phase 2Wire	30V AC ~ 360 V AC (ph-N)
2Phase 3Wire	30V AC ~ 360 V AC (ph-N)
Alternator Frequency	50 Hz /60Hz
Programmable Relay Output 1	5 A AC250V volt free output
Programmable Relay Output 2	5 A AC250V volt free output
Programmable Relay Output 3	10A AC250V volt free output
Programmable Relay Output 4	10A DC250V volt free output
Overall Dimension	107.6mm x 89.7mm x 60.7mm
CT Secondary Current	5A rated (maximum tested: 15A)
Working Conditions	Temperature: (-25~+70)°C; Humidity: (20~93)%RH
Storage Condition	Temperature: (-30~+80)°C
Insulating Intensity	Apply AC2.2kV voltage between high voltage terminal and low voltage terminal, and the leakage current is not more than 3mA within 1min.
Net Weight	0.30kg

4 OPERATION

Table 3 Key Descriptions

Icons	Function	Description
	Set/Confirm	Press and it shall enter password input interface; Move cursor in parameter settings and confirm the settings.
	Up/Increase	Scroll the screen up; Shift the cursor up or increase the set value in parameter settings.
	Down/Decrease	Scroll the screen down; Shift the cursor down or decrease the set value in parameter settings.
Press both  and  simultaneously and it can reset alarms.		

SmartGen

5 SCREEN DISPLAY

5.1 POWER DATA DISPLAY

Table 4 Power Data Display

1 st Screen	Description
UL-L 380V 380V 380 V	Line voltage Uab, Ubc, Uca
UL-N 220V 220V 220 V	Phase voltage Ua, Ub, Uc
I: 500A 500A 500 A	Current, Ia, Ib, Ic
P: 330 kW Q : 0 kvar	Active power, Reactive power
PF 1.00 50.00Hz	Average power factor, Frequency
2 nd Screen	Description
P(kW) Q(kVar) S(kVA)	Active power display、Reactive power display、Apparent power display
A: 110 0 110.0	A phase: active power, reactive power, apparent power
B: 110 0 110.0	B Phase: active power, reactive power, apparent power
C: 110 0 110.0	C Phase: active power, reactive power, apparent power
PF 1.00 1.00 1.00	A phase, B phase and C phase power factors
3 rd Screen	Description
THDu(%) THDi(%)	Voltage harmonic distortion rate, current harmonic distortion rate
A: 0.5 0.3	A phase: voltage harmonic distortion rate, current harmonic distortion rate
B: 0.5 0.3	B phase: voltage harmonic distortion rate, current harmonic distortion rate
C: 0.5 0.3	C phase: voltage harmonic distortion rate, current harmonic distortion rate
Phase Seq 0° 120° 240°	Phase sequence
4 th Screen	Description
Total kWh 276.3 kWh	Total active energy
Total kvarh 200.0 kvarh	Total reactive energy
Active Power %: 25%	Active power percentage
Reactive Power %: 5%	Reactive power percentage

5.2 ALARM DISPLAY

All alarm information (trip alarm and warning alarm) collected by the module is displayed on the alarm screen as bellow.

Table 5 Alarm Display

Display	Description
Alarm	Title
Warning Alarm	Alarm type
Under Volt Warning	Alarm content

5.3 MODULE INFORMATION DISPLAY

Module I/O status, software version, hardware version and release time are displayed on this screen as bellow.

Table 6 Module Information Display

Display	Description	
OUT: 1 2 3 4 IN: 1 2  Software Version: V1.0 Hardware Version: V1.2 Issue Date: 2019-07-20	No. of output port	No. of input port
	Output port status	Input port status
	Software version	
	Hardware version	
	Issue date	

5.4 HARMONIC DATA DISPLAY

Press Set button and refer to Table 7. Select the harmonic item to be displayed by Up/Down keys. Press Set button and it shall enter the selected harmonic item to be displayed. Among them voltage collection displays 3 circuits, and current collection displays 3 circuits. For each circuit 3-31 times odd harmonic are displayed.

Table 7 Module Harmonic Display

Display	Description
Return	Press Set button and it shall return.
Parameter Set	Press Set button and it will enter parameter settings.(Password is needed)
Thu L1(3-31)	Press Set button and it will enter Voltage L1 harmonic display each time.
Thu L2(3-31)	Press Set button and it will enter Voltage L2 harmonic display each time.
3-7 0.0% 0.0% 0.0%	3-7 times harmonic display
9-13 0.0% 0.0% 0.0%	9-13 times harmonic display
15-19 0.0% 0.0% 0.0%	15-19 times harmonic display
21-25 0.0% 0.0% 0.0%	21-25 times harmonic display
27-31 0.0% 0.0% 0.0%	27-31 times harmonic display

6 PROTECTION

6.1 WARNING

When controller detects the warning signals, alarm indicator flashes and LCD displays the warning information.

Table 8 Warning Alarms

No.	Type	Description
1	Over Volt Warn	When the module detects that the generator-set voltage has exceeded the pre-set value, it will initiate a warning alarm and the corresponding alarm information will be displayed on LCD.
2	Under Volt Warn	When the module detects that the generator-set voltage has fallen below the pre-set value, it will initiate a warning alarm and the corresponding alarm information will be displayed on LCD.
3	Over Frequency Warn	When the module detects that the generator-set frequency has exceeded the pre-set value, it will initiate a warning alarm and the corresponding alarm information will be displayed on LCD.
4	Under Frequency Warn	When the module detects that the generator-set frequency has fallen below the pre-set value, it will initiate a warning alarm and the corresponding alarm information will be displayed on LCD.
5	Over Power Warn	When the module detects that the generator-set power (power is positive) has exceeded the pre-set value, it will initiate a warning alarm and the corresponding alarm information will be displayed on LCD.
6	Over Current Pre-alarm	When module detects genset current is above the pre-set over current warning limits, module issues warning alarm signal, and alarm information will be displayed on LCD at the same time.
7	Reverse Power Warn	When the module detects that the generator-set reverse power value (power is negative) has exceeded the pre-set value, it will initiate a warning alarm and the corresponding alarm information will be displayed on LCD.
8	Input 1 Warn	When user configured input warning is active, module shall issue warning alarm signal, and Input 1 warn (user configurable) shall be displayed on the LCD.
9	Input 2 Warn	When user configured input warning is active, module shall issue warning alarm signal, and Input 2 warn (user configurable) shall be displayed on the LCD.
10	Volt. L1 THDi Over	When module detects Volt. L1 harmonic distortion rate is above preset limit, it will send out warning signal and the corresponding alarm information will be displayed on LCD.
11	Volt. L2 THDi Over	When module detects Volt. L2 harmonic distortion rate is above preset limit, it will send out warning signal and the corresponding alarm information will be displayed on LCD.
12	Volt. L3 THDi Over	When module detects Volt. L3 harmonic distortion rate is above preset limit, it will send out warning signal and the corresponding alarm information will be displayed on LCD.
13	Volt. L1 THi	When module detects Volt. L1 each time harmonic is above pre-set limit, it



No.	Type	Description
	Over	will send out warning signal and the corresponding alarm information will be displayed on LCD.
14	Volt. L2 THi Over	When module detects Volt. L2 each time harmonic is above pre-set limit, it will send out warning signal and the corresponding alarm information will be displayed on LCD.
15	Volt. L3 THi Over	When module detects Volt. L3 each time harmonic is above pre-set limit, it will send out warning signal and the corresponding alarm information will be displayed on LCD.
16	Current. L1 THDi Over	When module detects Current L1 harmonic distortion rate is above preset limit, it will send out warning signal and the corresponding alarm information will be displayed on LCD.
17	Current. L2 THDi Over	When module detects Current L2 harmonic distortion rate is above preset limit, it will send out warning signal and the corresponding alarm information will be displayed on LCD.
18	Current. L3 THDi Over	When module detects Current L3 harmonic distortion rate is above preset limit, it will send out warning signal and the corresponding alarm information will be displayed on LCD.
19	Current. L1 THi Over	When module detects Current L1 each time harmonic is above pre-set limit, it will send out warning signal and the corresponding alarm information will be displayed on LCD.
20	Current. L2 THi Over	When module detects Current L2 each time harmonic is above pre-set limit, it will send out warning signal and the corresponding alarm information will be displayed on LCD.
21	Current. L3 THi Over	When module detects Current L3 each time harmonic is above pre-set limit, it will send out warning signal and the corresponding alarm information will be displayed on LCD.

6.2 TRIP ALARM

When module detects trip alarm, it will send signals to trip the generator and the corresponding alarm information will be displayed on LCD.

Table 9 Trip Alarms

No.	Type	Description
1	Over Voltage Trip	When the module detects that the generator-set voltage has exceeded the pre-set value, it will initiate a trip alarm and the corresponding alarm information will be displayed on LCD.
2	Under Voltage Trip	When the module detects that the generator-set voltage has fallen below the pre-set value, it will initiate a trip alarm and the corresponding alarm information will be displayed on LCD.
3	Over Frequency Trip	When the module detects that the generator-set frequency has exceeded the pre-set value, it will initiate a trip alarm and the corresponding alarm information will be displayed on LCD.
4	Under Frequency Trip	When the module detects that the generator-set frequency has fallen below the pre-set value, it will initiate a trip alarm and the corresponding alarm information will be displayed on LCD.
5	Over Power Trip	When the module detects that the generator-set power (power is positive) has exceeded the pre-set value, it will initiate a trip alarm and the corresponding alarm information will be displayed on LCD.
6	Over Current Short Trip	When the module detects that the generator-set current has exceeded the pre-set value, it will initiate a warning alarm and the corresponding alarm information will be displayed on LCD.
7	Over Current Long Trip	When the module detects that the genset current has exceeded the pre-set value, it will initiate a warning alarm and the corresponding alarm information will be displayed on LCD.
8	Reverse Power Trip	When the module detects that the generator-set reverse power value (power is negative) has exceeded the pre-set value, it will initiate a warning alarm and the corresponding alarm information will be displayed on LCD.
9	Loss of Phase Trip	When the module detects that generator-set voltage phase loss, it will initiate trip alarm signals and the corresponding alarm information will be displayed on LCD.
10	Phase Sequence Wrong Trip	When the module detects that generator-set voltage phase sequence wrong, it will initiate trip alarm signals and the corresponding alarm information will be displayed on LCD.
11	Input 1 Trip	When user configured input trip is active and module will send trip alarm signal, and Input 1 Trip (user configurable) will be displayed on the LCD.
12	Input 2 Trip	When user configured input trip is active and module will send trip alarm signal, and Input 2 Trip (user configurable) will be displayed on the LCD.

7 WIRING CONNECTION

HMP300 module panel is as follows:

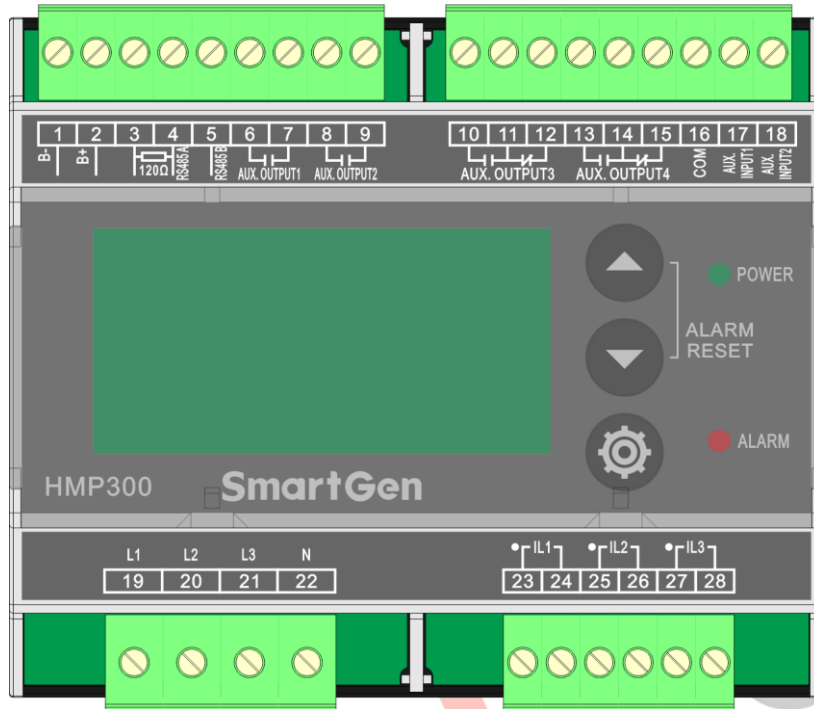

Fig. 1 HMP300 Panel



Table 10 Terminal Wiring Connection

No.	Function	Cable Size	Remarks
1	B-	1.5mm ²	Connected with negative of starter battery, engine starter battery can be used directly.
2	B+	1.5mm ²	Connected with positive of starter battery, engine starter battery can be used directly.
3	120Ω	1.0mm ²	After short connecting with RS485, there is no need to externally connect with a 120Ω resistor.
4	RS485A	1.0mm ²	RS485 communication port, which supports MODBUS communication protocol.
5	RS485B	1.0mm ²	
6	Aux. Output 1	1.0mm ²	Relay normally open volt free contact, rated 5A, and volt free contact output.
7		1.0mm ²	
8	Aux. Output 2	1.0mm ²	Relay normally open volt free contact, rated 5A, and volt free contact output.
9		1.0mm ²	
10	Aux. Output 3	1.0mm ²	Relay normally open volt free contact, rated 10A, and volt free contact output.
11		1.0mm ²	
12		1.0mm ²	
13	Aux. Output 4	1.0mm ²	Relay normally open volt free contact, rated 10A, and volt free contact output.
14		1.0mm ²	
15		1.0mm ²	
16	COM	1.0mm ²	Programmable input common terminal
17	AUX. INPUT 1	0.5mm ²	Programmable input 1
18	AUX. INPUT 2	0.5mm ²	Programmable input 2
19	Gen L1 Phase Voltage Monitoring Input	1.0mm ²	Connected with genset output U phase (2A fuse is recommended.)
20	Gen L2 Phase Voltage Monitoring Input	1.0mm ²	Connected with genset output V phase (2A fuse is recommended.)
21	Gen L3 Phase Voltage Monitoring Input	1.0mm ²	Connected with genset output W phase (2A fuse is recommended.)
22	Gen N Wire Input	1.0mm ²	Connected with genset output N wire
33	CT A Phase Monitoring	2.5mm ²	External connected current transformer secondary coil (5A rated, maximum 15A).
24		2.5mm ²	
25	CT B Phase Monitoring	2.5mm ²	External connected current transformer secondary coil (5A rated, maximum 15A).
26		2.5mm ²	
27	CT C Phase Monitoring	2.5mm ²	External connected current transformer secondary coil (5A rated, maximum 15A).
28		2.5mm ²	

For details see 8.2.

8 SCOPES AND DEFINITIONS OF PROGRAMMABLE PARAMETERS

8.1 CONTENTS AND SCOPES OF PARAMETERS

Table 11 Parameter Settings and Scopes

No	Items	Range	Default	Description
Voltage Settings				
1	AC System	(0-3)s	1	0: 3P4W 1: 3P3W 2: 2P3W 3: 1P2W
2	Rated Voltage	(30-30000)V	400	Provide standard for over/under voltage and voltage on load. If voltage transformer is used, this value is primary voltage of transformer. When AC system is 3P3W, this setting value is line voltage; for other supply AC systems, it is phase voltage.
3	PT Fitted Enable	(0-1) 0: Disabled 1: Enabled	0	When it is enabled, voltage value display in proportion can be realized on PT application.
4	Primary Voltage	(30-30000)	100	Primary voltage of voltage transformer.
5	Secondary Voltage	(30-1000)	100	Secondary voltage of voltage transformer.
6	Over Volt Warning Enabled	(0-1) 0: Disabled 1: Enabled	1	When it is enabled, module starts to detect over voltage warning.
7	Over Volt Warning Value	(0-200)%	110	When generator voltage has exceeded the setting value and warning delay is expired, module will initiate over voltage warning alarm.
8	Over Volt Warning Delay	(0-3600)s	3	Time duration from alarm is detected to alarm is initiated.
9	Over Volt Trip Enabled	(0-1) 0: Disabled 1: Enabled	1	When it is enabled, module starts to detect over voltage trip.
10	Over Volt Trip Value	(0-200)%	120	When generator voltage has exceeded the setting value and trip delay is expired, module will initiate over voltage trip alarm.
11	Over Volt Trip Delay	(0-3600)s	2	Time duration from alarm is detected to alarm is initiated.
12	Under Volt Warning Enabled	(0-1) 0: Disabled 1: Enabled	1	When it is enabled, module starts to detect under voltage warning.
13	Under Volt Warning Value	(0-200)%	84	When generator voltage has fallen below the setting value and warning delay is expired,



No	Items	Range	Default	Description
				module will initiate under voltage warning alarm.
14	Under Volt Warning Delay	(0-3600)s	3	Time duration from alarm is detected to alarm is initiated.
15	Under Volt Trip Enabled	(0-1) 0: Disabled 1: Enabled	1	When it is enabled, module starts to detect under voltage trip.
16	Under Volt Trip Value	(0-200)%	80	When generator voltage has fallen below the setting value and trip delay is expired, module will initiate under voltage trip alarm.
17	Under Volt Trip Delay	(0-3600)s	2	Time duration from alarm is detected to alarm is initiated.
18	Loss of Phase Detection Enabled	(0-1) 0: Disabled 1: Enabled	0	When it is enabled, loss of phase warning starts to be detected.
19	Phase Sequence Wrong Detection Enabled	(0-1) 0: Disabled 1: Enabled	0	When it is enabled, phase sequence wrong warning starts to be detected.
20	Under Volt Threshold Voltage	(0-200)%	60	When threshold voltage is exceeded, module starts to detect under voltage trip.
21	Load Voltage	(0-200)%	90	When module detects voltage is above this limit, it allows voltage of load conditions is satisfied.
22	Volt. ThDu Alarm	(0-1) 0: Disabled 1: Enabled	0	After it is enabled, module starts to detect voltage harmonic distortion rate alarm.
23	Set Value	(0-100)%	5	When module detects any one of voltage harmonic distortion rate is above the pre-set threshold, it shall issue alarm information.
24	Warn Delay	(0-3600)s	2	Time duration from alarm is detected to alarm is initiated.
25	Volt. Thu Alarm	(0-1) 0: Disabled 1: Enabled	0	After it is enabled, module starts to detect voltage harmonic alarm for each time.
26	Set Value	(0-100)%	3	When module detects any one of voltage harmonic for each time is above the pre-set threshold, it will issue alarm information.
27	Warn Delay	(0-3600)s	2	Time duration from alarm is detected to alarm is initiated.
Frequency Settings				
28	Rated Frequency	(50.0-60.0) Hz	50.0	Provide standard for over/under frequency and frequency on load.
29	Over Frequency Warning Enabled	(0-1) 0: Disabled	1	When it is enabled, module starts to detect over frequency warning.



No	Items	Range	Default	Description
		1: Enabled		
30	Over Frequency Warning Value	(0-200)%	110	When generator frequency has exceeded the setting value and warning delay is expired, module will initiate over frequency warning alarm.
31	Over Frequency Warning Delay	(0-3600)s	3	Time duration from alarm is detected to alarm is initiated.
32	Over Frequency Trip Enabled	(0-1) 0: Disabled 1: Enabled	1	When it is enabled, module starts to detect over frequency trip.
33	Over Frequency Trip Value	(0-200)%	114	When generator frequency has exceeded the setting value and warning delay is expired, module will initiate over frequency trip alarm.
34	Over Frequency Trip Delay	(0-3600)s	2	Time duration from alarm is detected to alarm is initiated.
35	Under Frequency Warning Enabled	(0-1) 0: Disabled 1: Enabled	1	When it is enabled, module starts to detect under frequency warning.
36	Under Frequency Warning Value	(0-200)%	84	When generator frequency has fallen below the setting value and warning delay is expired, module will initiate under frequency warning alarm.
37	Under Frequency Warning Delay	(0-3600)s	3	Time duration from alarm is detected to alarm is initiated.
38	Under Frequency Trip Enabled	(0-1) 0: Disabled 1: Enabled	1	When it is enabled, module starts to detect under frequency trip.
39	Under Frequency Trip Value	(0-200)%	80	When generator frequency has fallen below the setting value and warning delay is expired, module will initiate under frequency trip alarm.
40	Under Frequency Trip Delay	(0-3600)s	2	Time duration from alarm is detected to alarm is initiated.
41	Frequency On Load	(0-200)%	90	When module detects frequency has exceeded the setting value, it allows frequency of load conditions is satisfied.
Current Settings				
42	Rated Full-load Current	(5-6000)A	500	It is generator's rated current, and used for providing standard for load current.
43	Current Transformer Ratio	(5-6000)/5	500	Externally connected current transformer ratio.
44	Over Current Long Trip	(0-1) 0: Disabled	1	After enabled, module starts to detect for over current long trip.



No	Items	Range	Default	Description
		1: Enabled		
45	Over Current Long Trip Value	(0-300)%	110	When current exceeds this value and this lasts for pre-set delay time, module issues over current long trip alarm.
46	Over Current Long Trip Delay	(0-999.9)s	10.0	Time from when module detects alarm to alarm is issued.
47	Over Current Long Delay Type	(0-1) 0: DMT 1: IDMT	0	If DMT is set, do alarm delay handle by setting fixed delay time; If IDMT is set, do alarm delay handle by setting multiplier.
48	Over Current Long Delay Multiplier	(1-36)	36	When IDMT is active, alarm delay can be done by setting this multiplier.
49	Over Current Short Trip	(0-1) 0: Disabled 1: Enabled	1	After enabled, module starts to detect for over current short trip.
50	Over Current Short Trip Value	(0-300)%	114	When current exceeds this value and this lasts for pre-set delay time, module issues over current short trip alarm.
51	Over Current Short Trip Delay	(0-999.9)s	2.0	Time from when module detects alarm to alarm is issued.
52	Over Current Short Delay Type	(0-1) 0: DMT 1: IDMT	0	If DMT is set, do alarm delay handle by setting fixed delay time; If IDMT is set, do alarm delay handle by setting multiplier.
53	Over Current Short Delay Multiplier	(1-36)	36	When IDMT is active, alarm delay can be done by setting this multiplier.
54	Current Pre-alarm Enabled	(0-1) 0: Disabled 1: Enabled	1	When it is enabled, module starts to detect current pre-alarm.
55	Current Pre-alarm Value	(0-300)%	100	When current has exceeded this value and warning delay is expired, module will initiate over current pre-alarm signal.
56	Current Pre-alarm Delay	(0-3600)s	3	Time duration from alarm is detected to alarm is initiated.
57	Current Pre-alarm Delay Type	(0-1) 0: DMT 1: IDMT	0	If DMT is set, do alarm delay handle by setting fixed delay time; If IDMT is set, do alarm delay handle by setting multiplier.
58	Current Pre-alarm Delay Multiplier	(1-36)	36	When IDMT is active, alarm delay can be done by setting this multiplier.
59	Current Harmonic Distortion Rate Warning Enabled	(0-1) 0: Disabled 1: Enabled	0	When it is enabled, module starts to detect current harmonic distortion rate.
60	Harmonic Distortion	(0-100%)	5	When module detects any one of current



No	Items	Range	Default	Description
	Rate Warning Value			harmonic distortion rate is above the preset value, it shall initiate alarm information.
61	Harmonic Distortion Rate Warning Delay	(0-3600)s	2	Time duration from alarm is detected to alarm is initiated.
62	Current Harmonic Warning Enabled	(0-1) 0: Disabled 1: Enabled	0	When it is enabled, module starts to detect current harmonic alarm for each time.
63	Harmonic Warning Value	(0-100%)	3	When module detects any one of current harmonic for each time is above the pre-set value, it shall initiate alarm information.
64	Harmonic Warning Delay	(0-3600)s	2	Time duration from alarm is detected to alarm is initiated.
Power Settings				
65	Rated Power	(0-6000)kW	276	It is generator's rated power, and used for providing standard for power detection.
66	Rated Reactive Power	(0-6000)kvar	200	It is generator's rated reactive power, and used for providing standard for reactive percentage.
67	Over Power Warning Enabled	(0-1) 0: Disabled 1: Enabled	1	When it is enabled, module starts to detect over power warning.
68	Over Power Warning Value	(0-200)%	110	When generator current power (positive) has exceeded the setting value and warning delay is expired, module will initiate over power warning alarm.
69	Over Power Warning Delay	(0-3600)s	3	Time duration from alarm is detected to alarm is initiated.
70	Over Power Trip Enabled	(0-1) 0: Disabled 1: Enabled	1	When it is enabled, module starts to detect over power trip.
71	Over Power Trip Value	(0-200)%	114	When generator current power (positive) has exceeded the setting value and trip delay is expired, module will initiate over power trip alarm.
72	Over Power Trip Delay	(0-3600)s	2	Time duration from alarm is detected to alarm is initiated.
73	Reverse Power Warning Enabled	(0-1) 0: Disabled 1: Enabled	1	When it is enabled, module starts to detect reverse power warning.
74	Reverse Power Warning Value	(0-200)%	20	When reverse power value (negative) has exceeded the setting value and warning delay is expired, module will initiate reverse power warning alarm.
75	Reverse Power	(0-3600)s	3	Time duration from alarm is detected to



No	Items	Range	Default	Description
	Warning Delay			alarm is initiated.
76	Reverse Power Trip Enabled	(0-1) 0: Disabled 1: Enabled	1	When it is enabled, module starts to detect reverse power trip.
77	Reverse Power Trip Value	(0-200)%	30	When reverse power value (negative) has exceeded the setting value and trip delay is expired, module will initiate reverse power trip alarm.
78	Reverse Power Trip Delay	(0-3600)s	2	Time duration from alarm is detected to alarm is initiated.
Output Port Settings				
79	Aux. Output 1 Setting	(0-30)	0	Factory default: Not Used Please see Table 12 for output port function configuration.
80	Aux. Output 1 Type	(0-1)	0	0: Normally open; 1: Normally close
81	Aux. Output 2 Setting	(0-30)	0	Factory default: Not Used Please see Table 12 for output port function configuration.
82	Aux. Output 2 Type	(0-1)	0	0: Normally open; 1: Normally close
83	Aux. Output 3 Setting	(0-30)	0	Factory default: Not Used Please see Table 12 for output port function configuration.
84	Aux. Output 3 Type	(0-1)	0	0: Normally open; 1: Normally close
85	Aux. Output 4 Setting	(0-30)	0	Factory default: Not Used Please see Table 12 for output port function configuration.
86	Aux. Output 4 Type	(0-1)	0	0: Normally open; 1: Normally close
Input Port Settings				
87	Aux. Input 1 Setting	(0-20)	0	Factory default: Not Used Please see Table 14 for input port function configuration.
88	Aux Input 1 Type	(0-1)	0	0: Close to activate 1: Open to activate
89	Aux. Input 2 Setting	(0-20)	0	Factory default: Not Used Please see Table 14 for input port function configuration.
90	Aux Input 2 Type	(0-1)	0	0: Close to activate 1: Open to activate
Module Settings				
91	Module Address	(1-254)	1	Module address for remote monitoring control.
92	RS485 Baud rate	(0-2) 0:9600bps 1:19200bps 2:38400bps	0	RS485 communication baud rate configuration.
93	Language Selection	(0-1)	0	0: Simplified Chinese; 1: English;



No	Items	Range	Default	Description
94	Password Setting	(0-9999)	00318	It is used to enter parameter settings.
95	Closing Time	(0-20.0) s	5.0	It is output time of allowing on load output after satisfying close conditions; when it is set to 0, it is constant output.
96	Power Data Send Enable	(0-1) 0: Disabled 1: Enabled	0	Real-time power data percentage;
97	Backlight Setting Delay	(0-3600)s	60	It is used to define backlight on time.

SmartGen

8.2 DEFINABLE CONTENTS OF PROGRAMMABLE OUTPUT PORTS 1~4

Table 12 Programmable Outputs 1-4

No.	Items	Description
0	Not Used	Output port is deactivated when “Not Used” is selected.
1	Common Alarm	Output when module detects alarms occurred.
2	Common Warning Alarm	Output when module detects warning alarms occurred.
3	Common Trip Alarm	Output when module detects trip alarms occurred.
4	Over Volt Trip Alarm	Output when over voltage trip alarms occur.
5	Under Volt Trip Alarm	Output when under voltage trip alarms occur.
6	Loss of Phase Trip Alarm	Output when loss of phase trip alarms occur.
7	Phase Sequence Wrong Trip Alarm	Output when phase sequence wrong trip alarms occur.
8	Over Frequency Trip Alarm	Output when over frequency trip alarms occur.
9	Under Frequency Trip Alarm	Output when under frequency trip alarms occur.
10	Over Current Short Trip Alarm	Output when over current short trip alarms occur.
11	Over Current Pre-alarm	Output when over current pre-alarms occur.
12	Over Power Trip Alarm	Output when generator over power trip alarms occur.
13	Reserved	Reserved
14	Reverse Power Trip Alarm	Output when generator reverse power trip alarms occur.
15	Over Volt Warning	Output when generator over voltage warning alarms occur.
16	Under Volt Warning	Output when generator under voltage warning alarms occur.
17	Allowing On Load Output	Output when on load conditions are satisfied.
18	Input 1 Active	Output when Aux. Input 1 is active.
19	Over Frequency Warning	Output when generator over frequency warning alarms occur.
20	Under Frequency Warning	Output when generator under frequency warning alarms occur.
21	Input 2 Active	Output when Aux. Input 2 is active.
22	Over Current Long Trip	Output when generator over current long trip alarms occur.
23	Reserved	Reserved
24	Over Power Warning	Output when generator over power warning alarms occur.
25	Voltage Harmonic Distortion Rate Override	Output when any circuit of voltage harmonic distortion rate is overriding.
26	Reverse Power Warning	Output when generator reverse power warning alarms occur.
27	Custom Output	Define Column A output function and Column B output function; when one of both is active, it will output. For details please see Table 13.
28	Volt. Harmonic Override for each time	Output when any circuit of volt. harmonic for each time is overriding.



No.	Items	Description
29	Current Harmonic Distortion Rate Override	Output when any circuit of current harmonic distortion rate is overriding.
30	Current Harmonic Override for each time	Output when any circuit of current harmonic for each time is overriding.









Table 13 Custom Outputs Form

No.	Custom Output Column A	Custom Output Column B
0	Over Volt Warning Alarm	Over Volt Warning Alarm
1	Under Volt Warning Alarm	Under Volt Warning Alarm
2	Over Frequency Warning Alarm	Over Frequency Warning Alarm
3	Under Frequency Warning Alarm	Under Frequency Warning Alarm
4	Over Power Warning	Over Power Warning
5	Over Current Long Trip	Over Current Warning
6	Reverse Power Warning	Reverse Power Warning
7	Phase Sequence Wrong Trip Alarm	Phase Sequence Wrong Trip Alarm
8	Over Volt Trip Alarm	Over Volt Trip Alarm
9	Under Volt Trip Alarm	Under Volt Trip Alarm
10	Over Frequency Trip Alarm	Over Frequency Trip Alarm
11	Under Frequency Trip Alarm	Under Frequency Trip Alarm
12	Over Power Trip Alarm	Over Power Trip Alarm
13	Over Current Short Trip Alarm	Over Current Trip Alarm
14	Reverse Power Trip Alarm	Reverse Power Trip Alarm
15	Loss of Phase Trip Alarm	Loss of Phase Trip Alarm
16	Over Current Pre-alarm	Over Current Pre-alarm
17	Over Current Trip	Over Current Trip
18	Input 1 Active	Input 1 Active
19	Input 2 Active	Input 2 Active
20	Voltage Harmonic Distortion Rate Override	Voltage Harmonic Distortion Rate Override
21	Voltage Harmonic Override for each time	Voltage Harmonic Override for each time
22	Current Harmonic Distortion Rate Override	Current Harmonic Distortion Rate Override
23	Current Harmonic Override for each time	Current Harmonic Override for each time

Table 14 Input Port Function Configurations

No.	Type	Function Description
0	Not Used	Input port function is inhibited.
1	User Configured	Users can define the following functions: Action: warning; when it is active, module shall issue input warning signal, and meanwhile the corresponding information is displayed on LCD. Action: trip; when it is active, module will issue trip signal, and meanwhile corresponding alarm information is displayed on the LCD. Delay: Interval time from module detects input active to alarm is issued.
2	Alarm Reset	Alarm is reset when input is active.
3	Reserved	Reserved
4	Reserved	Reserved
5-20	Reserved	Reserved

9 PARAMETERS SETTING

After module is power on, press  to enter selectable screen. Press  to select parameter setting. Then press  to confirm and enter password input interface. Input correct password and parameter setting screen can be entered (default: 0318). By  and  the item to be set can be selected. Then press  to set. Press  to add value and press  to decrease value. After settings are completed, press  to confirm.

Parameters also can be set through PC software by connecting with SG72 module. Password "318" is needed to be input to do parameter settings via the module. When much more items needs to set or password is forgotten, for example: Voltage and Current calibration, please contact the factory.

NOTES:

- 1) Over voltage set value must be higher than under voltage set value, otherwise over voltage and under voltage conditions may occur simultaneously.
- 2) For unneeded alarms please select "Disabled" in the alarm enabled selection.

10 CUSTOM PROTOCOL FUNCTION

HMP300-2 module supports custom protocol function. Customers can choose max.120 address data to conduct data reading among PC software settings based on their own demands. Starting address is 5000, and data of each address can select from “03” function code data of JNPDJCA/JNPDJCB communication protocol.

Custom protocol is MODBUS communication protocol, and function code is 03.

Configuration Interface is as below:

Custom Protocol			
Addr	Name	Content	
5000	Custom Protocol Address 0	000 Common Alarm	
5001	Custom Protocol Address 1	001 Trip Alarm	
5002	Custom Protocol Address 2	002 Warning Alarm	
5003	Custom Protocol Address 3	003 Harmonic violation limit	
5004	Custom Protocol Address 4	004 Reserved	
5005	Custom Protocol Address 5	005 input port	
5006	Custom Protocol Address 6	006 Reserved	
5007	Custom Protocol Address 7	007 output port	
5008	Custom Protocol Address 8	008 Reserved	
5009	Custom Protocol Address 9	009 Gen UAB	
5010	Custom Protocol Address 10	010 Gen UBC	
5011	Custom Protocol Address 11	011 Gen UCA	
5012	Custom Protocol Address 12	012 Gen UA	
5013	Custom Protocol Address 13	013 Gen UB	
5014	Custom Protocol Address 14	014 Gen UC	
5015	Custom Protocol Address 15	015 Gen UA Phase	
5016	Custom Protocol Address 16	016 Gen UB Phase	
5017	Custom Protocol Address 17	017 Gen UC Phase	
5018	Custom Protocol Address 18	018 Gen Frequency	
5019	Custom Protocol Address 19	019 Reserved	
5020	Custom Protocol Address 20	020 Reserved	
5021	Custom Protocol Address 21	021 Reserved	
5022	Custom Protocol Address 22	022 IA	
5023	Custom Protocol Address 23	023 IB	
5024	Custom Protocol Address 24	024 IC	
5025	Custom Protocol Address 25	025 active percentage	
5026	Custom Protocol Address 26	026 Reactive percentage	
5027	Custom Protocol Address 27	027 Reserved	
5028	Custom Protocol Address 28	028 Reserved	
5029	Custom Protocol Address 29	029 Reserved	
5030	Custom Protocol Address 30	030 AC Input Method	

Fig. 2 Custom Protocol Interface

11 TYPICAL APPLICATION

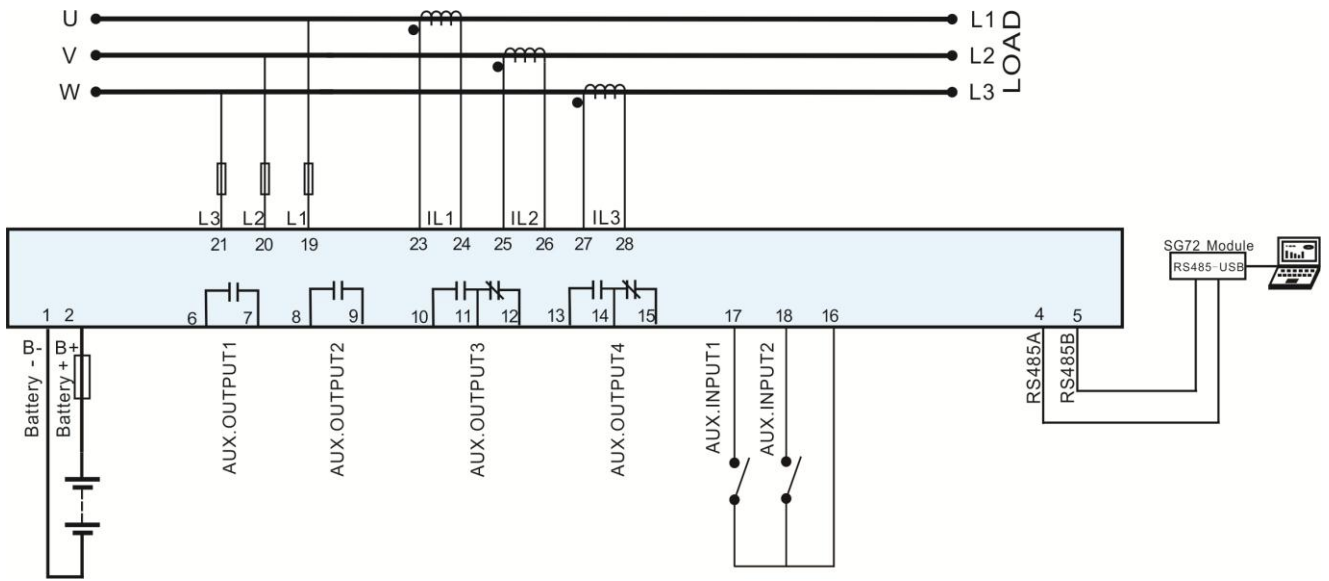

Fig. 3 HMP300 Typical Application

SmartGen

12 INSTALLATION

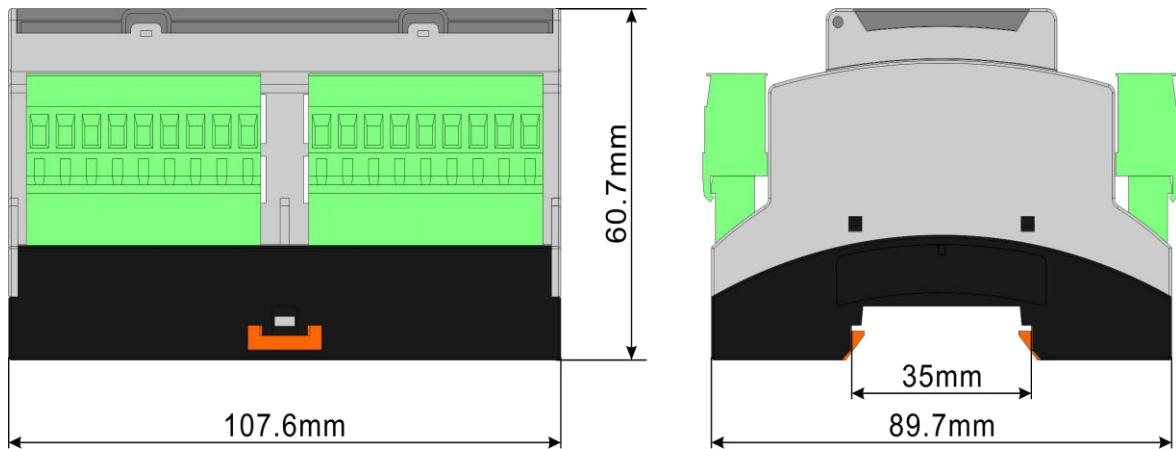

Fig. 4 Overall Dimensions and Cutout

Application Notice:

✧ OUTPUT AND EXPAND RELAYS

All outputs are relay contact outputs. If it needs to expand the relays, please add freewheel diode to both ends of expand relay's coils (when coils of relay has DC current), or increase resistance-capacitance return circuit (when coils of relay has AC current), in order to prevent disturbance to controller or other equipments.

✧ AC CURRENT INPUT

Current input must be connected to outside current transformer. And the current transformer's secondary side current must be 5A (maximum can be 15A). At the same time, the phase of current transformer and input voltage phase must be correct. Otherwise, the collected current and active power may not be correct.

▲NOTE: When there is load current, transformer's secondary side is prohibited to open circuit.

✧ WITHSTAND VOLTAGE TEST

When relay has been installed on control panel, if high voltage test is to be done, please disconnect controller's all terminal connections, in order to prevent high voltage entering controller and damaging it.