



SmartGen
ideas for power

HMP300

POWER INTEGRATED PROTECTION MODULE

USER MANUAL



SMARTGEN (ZHENGZHOU) TECHNOLOGY CO., LTD.



Chinese trademark

SmartGen English trademark

SmartGen – make your generator *smart*

SmartGen Technology Co., Ltd.

No.28 Jinsuo Road

Zhengzhou

Henan Province

P. R. China

Tel: +86-371-67988888/67981888/67992951

+86-371-67981000(overseas)

Fax: +86-371-67992952

Web: www.smartgen.com.cn

www.smartgen.cn

Email: sales@smartgen.cn

All rights reserved. No part of this publication may be reproduced in any material form (including photocopying or storing in any medium by electronic means or other) without the written permission of the copyright holder.

Applications for the copyright holder's written permission to reproduce any part of this publication should be addressed to Smartgen Technology at the address above.

Any reference to trademarked product names used within this publication is owned by their respective companies.

SmartGen Technology reserves the right to change the contents of this document without prior notice.

Table 1 Software Version

Date	Version	Note
2017-09-22	1.0	Original release.
2019-11-05	1.1	Added differential protection contents.
2021-03-05	1.2	Modify the figure 1 error and update the format.



CONTENTS

1 OVERVIEW	4
2 PERFORMANCE AND CHARACTERISTICS.....	4
3 SPECIFICATION	5
4 OPERATION.....	5
5 SCREENS DISPLAY	6
5.1 POWER DATA DISPLAY	6
5.2 ALARM DISPLAY	7
5.3 MODULE INFORMATION DISPLAY.....	7
6 PROTECTION.....	8
6.1 WARNING.....	8
6.2 TRIP ALARM	9
7 WIRING CONNECTION.....	10
8 SCOPES AND DEFINITIONS OF PROGRAMMABLE PARAMETERS.....	12
8.1 CONTENTS AND SCOPES OF PARAMETERS.....	12
8.2 DEFINED CONTENTS OF PROGRAMMABLE OUTPUT PORTS 1~4	17
9 PARAMETERS SETTING.....	18
10 TYPICAL APPLICATION.....	19
11 INSTALLATION	20

1 OVERVIEW

HMP300 power integrated protection module integrates digitization, intelligentization and network technology, and are used for collecting generator-set data (voltage, current, power and frequency) and related action output for data errors to protect the device. It fits with LCD display, optional Chinese and English bilingual interface, and it is reliable and easy to use.

HMP300 power integrated protection module adopts micro-processor technology with precise parameter measuring, fixed value adjustment, set value adjusting functions etc. All parameters can be configured from front panel or through LINK interface via PC. It can be widely used in all types of marine/land electrical device with compact structure, advanced circuits, simple connections and high reliability.

2 PERFORMANCE AND CHARACTERISTICS

Main features are as below:

- 132x64 LCD display with backlight, selectable language interface (Chinese and English), push-button operation.
- Equipped with LINK communication port; Through LINK interface on PC, data and parameters can be monitored and adjusted.
- Equipped with CANBUS port, which can connect with HMC9000/HMC6000 module to realize power and engine data collecting and display at the same time.
- Differential protection function, and controller will issue related alarm information after differential protection is active.
- Protections for over/under voltage, over/under frequency, reverse power, over power and over current.
- Harmonic test function, and each phase voltage/current harmonic distortion rate can be tested.
- Suitable for 3-phase 4-wire, 3-phase 3-wire, single phase 2-wire, and 2-phase 3-wire systems with frequency 50/60Hz.
- Collects and shows 3-phase voltage, 3-phase current, frequency and power parameters.

Generator

Line voltage (Uab, Ubc, and Uca)

Phase voltage (Ua, Ub, and Uc)

Frequency Hz

Load

Current Ia, Ib, Ic A (unit)

Each phase and total active power P kW (unit)

Each phase and total reactive power Q kvar (unit)

Each phase and average power factor PF

- Parameter setting function: users are allowed to set and change parameters and parameters shall be stored in internal FLASH memory and cannot be lost even in case of power outage; most of them can be adjusted using front panel of the controller.
- Wide power supply range DC (8~35) V, suitable for different starting battery voltage environment.
- All parameters apply digital adjustment, instead of conventional analog modulation with normal potentiometer, improving whole reliability and stability.
- Module is mounted on the 35mm guide rail.





3 SPECIFICATION

Table 2 Technical Parameters

Items	Contents
Operating Voltage	DC8.0V to DC35.0V, Continuous Power Supply
Power Consumption	<3W (standby ≤2W)
Alternator Volt Input Range 3Phase 4Wire 3Phase 3Wire Single Phase 2Wire 2Phase 3Wire	30V AC ~ 360 V AC (ph-N) 30V AC ~ 620 V AC (ph-ph) 30V AC ~ 360 V AC (ph-N) 30V AC ~ 360 V AC (ph-N)
Alternator Frequency	50Hz/60Hz
Programmable Relay Output 1	5 A AC250V volt free output
Programmable Relay Output 2	5 A AC250V volt free output
Programmable Relay Output 3	10A AC250V volt free output
Programmable Relay Output 4	10A AC250V volt free output
Overall Dimension	107.6mm x 89.7mm x 60.7mm
CT Secondary Current	5A rated
Working Conditions	Temperature: (-25~+70)°C; Humidity: (20~93)%RH
Storage Condition	Temperature: (-25~+70)°C
Insulating Intensity	Apply AC2.2kV voltage between high voltage terminal and low voltage terminal and the leakage current is not more than 3mA within 1min.
Weight	0.30kg

4 OPERATION

Table 3 Key Description

Icons	Function	Description
	Set/Confirm	Pressing this key will enter into password screen; In setting parameter status, pressing this key will shift cursor or confirm the set value.
	Up/Increase	Scrolls the screen up; Shift the cursor up or increase the set value in parameter setting menu.
	Down/Decrease	Scrolls the screen down; Shift the cursor down or decrease the set value in parameter setting menu.
Pressing both  and  simultaneously can reset alarms.		

5 SCREENS DISPLAY

5.1 POWER DATA DISPLAY

Table 4 Power Data Display

1 st Screen	Description
UL-L 380V 380V 380 V	Line voltage Uab, Ubc, Uca
UL-N 220V 220V 220 V	Phase voltage Ua, Ub, Uc
I: 500A 500A 500 A	Current, Ia, Ib, Ic
P: 276 kW Q : 200 kvar	Active power, reactive power
PF 0.80 50.0Hz	Average power factor, frequency
2 nd Screen	Description
P(kW) Q(kvar) S(kVA)	Active power display, reactive power display, apparent power display
A: 89.0 65.0 110.0	A phase: active power, reactive power, apparent power
B: 89.0 65.0 110.0	B Phase: active power, reactive power, apparent power
C: 89.0 65.0 110.0	C Phase: active power, reactive power, apparent power
PF 0.80 0.80 0.80	A phase, B phase and C phase power factors
3 rd Screen	Description
THDu(%) THDi(%)	Voltage harmonic distortion rate, current harmonic distortion rate
A: 0.5 0.3	A phase: voltage harmonic distortion rate, current harmonic distortion rate
B: 0.5 0.3	B phase: voltage harmonic distortion rate, current harmonic distortion rate
C: 0.5 0.3	C phase: voltage harmonic distortion rate, current harmonic distortion rate
Phase Seq: 0° 120° 240°	Phase sequence
4 th Screen	Description
Total kWh 276.3 kWh	Total active energy
Total kvarh 200.0 kvarh	Total reactive energy
kWh % 32%	Active power percentage
kvarh % 32%	Reactive power percentage

5.2 ALARM DISPLAY

All alarm information (trip alarm and warning alarm) collected by the module is real-time displayed on the alarm screen as bellow:

Table 5 Alarm Display

Display Content	Description
Alarm	Page title
Warning Alarm	Alarm type
Under Volt Warning	Alarm content

5.3 MODULE INFORMATION DISPLAY

Module information including output port status, software version, hardware version and release time can be displayed on this screen as bellow:

Table 6 Module Information Display

Display Content	Description
OUT: 1 2 3 4 	Output port number
Software Version: V1.3	Outputs status
Hardware Version: V2.1	Software version
Issue Date: 2017-09-20	Hardware version
	Issue date



6 PROTECTION

6.1 WARNING

When controller detects the warning signals, alarm indicator flashes and LCD displays the warning information.

Table 7 Module Warning Types

No.	Type	Description
1	Over Volt Warning	When the module detects that the genset voltage has exceeded the pre-set value, it will initiate a warning alarm and the corresponding alarm information will be displayed on LCD.
2	Under Volt Warning	When the module detects that the genset voltage has fallen below the pre-set value, it will initiate a warning alarm and the corresponding alarm information will be displayed on LCD.
3	Over Frequency Warning	When the module detects that the genset frequency has exceeded the pre-set value, it will initiate a warning alarm and the corresponding alarm information will be displayed on LCD.
4	Under Frequency Warning	When the module detects that the genset frequency has fallen below the pre-set value, it will initiate a warning alarm and the corresponding alarm information will be displayed on LCD.
5	Over Power Warning	When the module detects that the genset power (power is positive) has exceeded the pre-set value, it will initiate a warning alarm and the corresponding alarm information will be displayed on LCD.
6	Over Current Warning	When the module detects that the genset current has exceeded the pre-set value, it will initiate a warning alarm and the corresponding alarm information will be displayed on LCD.
7	Current Pre-alarm	When module detects genset current is above the current pre-alarm limit, it will initiate a warning alarm and the corresponding alarm information will be displayed on LCD.
8	Reverse Power Warning	When the module detects that the genset reverse power value (power is negative) has exceeded the pre-set value, it will initiate a warning alarm and the corresponding alarm information will be displayed on LCD.
9	Differential Protection	When module detects differential current is above the pre-set current pre-alarm limit, it will initiate a warning alarm and the corresponding alarm information will be displayed on LCD.

6.2 TRIP ALARM

When controller detects trip alarm, it will send signals to trip the generator and the corresponding alarm information will be displayed on LCD.

Table 8 Trip Alarms

No.	Type	Description
1	Over Voltage Trip	When the module detects that the genset voltage has exceeded the pre-set value, it will initiate a trip alarm and the corresponding alarm information will be displayed on LCD.
2	Under Voltage Trip	When the module detects that the genset voltage has fallen below the pre-set value, it will initiate a trip alarm and the corresponding alarm information will be displayed on LCD.
3	Over Frequency Trip	When the module detects that the genset frequency has exceeded the pre-set value, it will initiate a trip alarm and the corresponding alarm information will be displayed on LCD.
4	Under Frequency Trip	When the module detects that the genset frequency has fallen below the pre-set value, it will initiate a trip alarm and the corresponding alarm information will be displayed on LCD.
5	Over Power Trip	When the module detects that the genset power (power is positive) has exceeded the pre-set value, it will initiate a trip alarm and the corresponding alarm information will be displayed on LCD.
6	Over Current Trip	When the module detects that the genset current has exceeded the pre-set value, it will initiate a warning alarm and the corresponding alarm information will be displayed on LCD.
7	Differential Protection Trip	When the module detects differential current is above the pre-set limit, it will initiate a warning alarm and the corresponding alarm information will be displayed on LCD.
8	Reverse Power Trip	When the module detects that the genset reverse power value (power is negative) has exceeded the pre-set value, it will initiate a warning alarm and the corresponding alarm information will be displayed on LCD.
9	Loss of Phase Trip	When the module detects that genset voltage phase loss, it will initiate trip alarm signals and the corresponding alarm information will be displayed on LCD.
10	Reverse Phase Sequence Trip	When the module detects that genset voltage phase sequence wrong, it will initiate trip alarm signals and the corresponding alarm information will be displayed on LCD.

7 WIRING CONNECTION

HMP300 controller panel is as below:

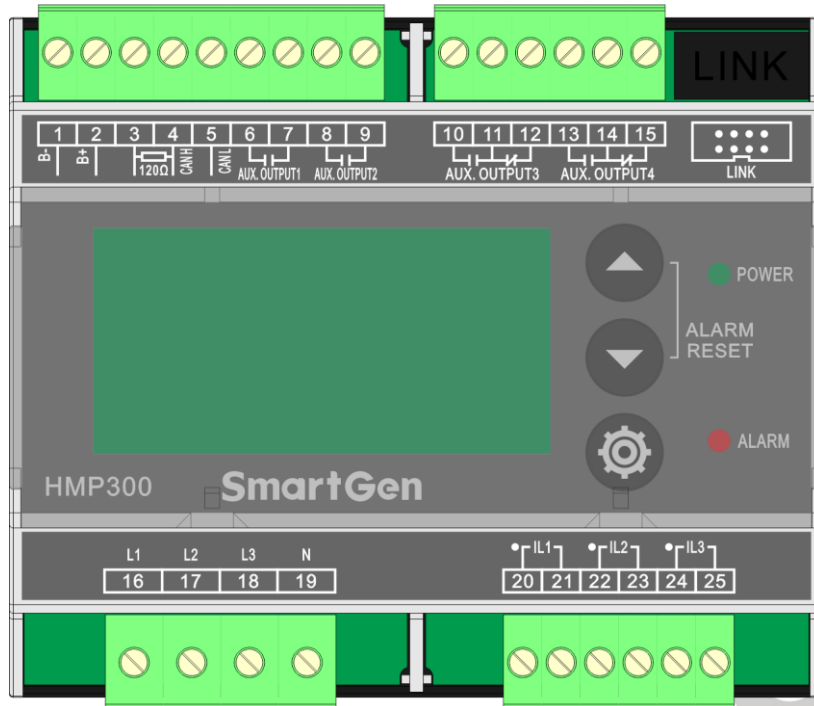

Fig. 1 HMP300 Panel Diagram



Table 9 Terminal Wiring Connection

No.	Function	Cable Size	Remarks
1	B-	1.5mm ²	Connected with negative of starter battery, engine starter battery can be used directly.
2	B+	1.5mm ²	Connected with positive of starter battery, engine starter battery can be used directly.
3	120Ω	1.0mm ²	After short connecting with CANL, it doesn't need to externally connect with 120Ω.
4	CANH	1.0mm ²	CANBUS Communication port, which supports J1939-81 power data communication protocol.
5	CANL	1.0mm ²	
6	Aux. Output 1	1.0mm ²	Relay normally open volt free contact, rated 5A, and volt free contact output.
7		1.0mm ²	
8	Aux. Output 2	1.0mm ²	Relay normally open volt free contact, rated 5A, and volt free contact output.
9		1.0mm ²	
10	Aux. Output 3	1.0mm ²	Relay normally open volt free contact, rated 10A, and volt free contact output.
11		1.0mm ²	
12		1.0mm ²	
13	Aux. Output 4	1.0mm ²	Relay normally open volt free contact, rated 10A, and volt free contact output.
14		1.0mm ²	
15		1.0mm ²	
16	Gen L1 Phase Volt Monitoring Input	1.0mm ²	Connect with output U Phase of generator (2A fuse is recommended).
17	Gen L2 Phase Volt Monitoring Input	1.0mm ²	Connect with output V Phase of generator (2A fuse is recommended).
18	Gen L3 Phase Volt Monitoring Input	1.0mm ²	Connect with output W Phase of generator (2A fuse is recommended).
19	Gen N Wire Input	1.0mm ²	Connect with output N Wire of generator.
20	CT A-Phase Monitoring Input	2.5mm ²	External connected current transformer secondary coil (rated 5A).
21		2.5mm ²	
22	CT B-Phase Monitoring Input	2.5mm ²	External connected current transformer secondary coil (rated 5A).
23		2.5mm ²	
24	CT C-Phase Monitoring Input	2.5mm ²	External connected current transformer secondary coil (rated 5A).
25		2.5mm ²	
LINK			Test software interface. Connect with PC test software via SG72 module.

Details see **8.2**.

8 SCOPES AND DEFINITIONS OF PROGRAMMABLE PARAMETERS

8.1 CONTENTS AND SCOPES OF PARAMETERS

Table 10 Parameter Setting Contents and Scopes

No	Items	Range	Default	Description
Voltage Settings				
1	AC System	(0-3)	0	0: 3P4W 1: 3P3W 2: 2P3W 3: 1P2W
2	Rated Voltage	(30-30000)V	230	Provide standard for over/under voltage and voltage on load. If voltage transformer is used, this value is primary voltage of transformer. When AC system is 3P3W, this setting value is line voltage; for other supply AC systems, it is phase voltage.
3	Voltage Transformer Enabled	(0-1) 0: Disabled 1: Enabled	0	Disabled
4	Primary Voltage	(30-30000)V	100	Primary voltage of voltage transformer.
5	Secondary Voltage	(30-1000)V	100	Secondary voltage of voltage transformer.
6	Over Volt Warning Enabled	(0-1) 0: Disabled 1: Enabled	1	When it is enabled, module starts to detect over voltage warning.
7	Over Volt Warning Value	(0-200)%	110%	When generator voltage has exceeded the set value and warning delay is expired, module will initiate over voltage warning alarm.
8	Over Volt Warning Delay	(0-3600)s	3	Time duration from alarm is detected to it initiates alarm.
9	Over Volt Trip Enabled	(0-1) 0: Disabled 1: Enabled	1	When it is enabled, module starts to detect over voltage trip.
10	Over Volt Trip Value	(0-200)%	120	When generator voltage has exceeded the set value and trip delay is expired, module will initiate over voltage trip alarm.
11	Over Volt Trip Delay	(0-3600)s	2	Time duration from alarm is detected to it initiates alarm.
12	Under Volt Warning Enabled	(0-1) 0: Disabled 1: Enabled	1	When it is enabled, module starts to detect under voltage warning.
13	Under Volt Warning Value	(0-200)%	84	When generator voltage has fallen below the set value and warning delay is expired,



No	Items	Range	Default	Description
				module will initiate under voltage warning alarm.
14	Under Volt Warning Delay	(0-3600)s	3	Time duration from alarm is detected to it initiates alarm.
15	Under Volt Trip Enabled	(0-1) 0: Disabled 1: Enabled	1	When it is enabled, module starts to detect under voltage trip.
16	Under Volt Trip Value	(0-200)%	80	When generator voltage has fallen below the set value and trip delay is expired, module will initiate under voltage trip alarm.
17	Under Volt Trip Delay	(0-3600)s	2	Time duration from alarm is detected to it initiates alarm.
18	Loss of Phase Detection Enabled	(0-1)	0	0: Disabled 1: Enabled
19	Phase Sequence Wrong Detection Enabled	(0-1)	0	
20	Under Volt Threshold Voltage	(0-200)%	60	When threshold voltage is exceeded, module starts to detect under voltage alarm.
21	Voltage On Load	(0-200)%	90	When voltage is over this threshold, it meets the on-load conditions.
Frequency Settings				
22	Rated Frequency	(50.0-60.0) Hz	50.0	Provide standard for over/under frequency and frequency on load.
23	Frequency On Load	(0-200)%	90	When frequency is over this value, it meets the on-load conditions.
24	Over Frequency Warning Enabled	(0-1) 0: Disabled 1: Enabled	1	When it is enabled, module starts to detect over frequency warning.
25	Over Frequency Warning Value	(0-200)%	110	When generator frequency has exceeded the set value and warning delay is expired, module will initiate over frequency warning alarm.
26	Over Frequency Warning Delay	(0-3600)s	3	Time duration from alarm is detected to it initiates alarm.
27	Over Frequency Trip Enabled	(0-1) 0: Disabled 1: Enabled	1	When it is enabled, module starts to detect over frequency trip.
28	Over Frequency Trip Value	(0-200)%	114	When generator frequency has exceeded the setting value and trip delay is expired, module will initiate over frequency trip alarm.
29	Over Frequency Trip	(0-3600)s	2	Time duration from alarm is detected to it



No	Items	Range	Default	Description
	Delay			initiates alarm.
30	Under Frequency Warning Enabled	(0-1) 0: Disabled 1: Enabled	1	When it is enabled, module starts to detect under frequency warning.
31	Under Frequency Warning Value	(0-200)%	84	When generator frequency has fallen below the set value and warning delay is expired, module will initiate under frequency warning alarm.
32	Under Frequency Warning Delay	(0-3600)s	3	Time duration from alarm is detected to it initiates alarm.
33	Under Frequency Trip Enabled	(0-1) 0: Disabled 1: Enabled	1	When it is enabled, module starts to detect under frequency trip.
34	Under Frequency Trip Value	(0-200)%	80	When generator frequency has fallen below the set value and trip delay is expired, module will initiate under frequency trip alarm.
35	Under Frequency Trip Delay	(0-3600)s	2	Time duration from alarm is detected to it initiates alarm.
Current Settings				
36	Rated Full-load Current	(5-6000)A	500	It is generator's rated current, and used for provide standard for load current.
37	Current Transformer Ratio/5	(5-6000)/5	500	External connected current transformer ratio.
38	Over Current Warning Enabled	(0-1) 0: Disabled 1: Enabled	1	When it is enabled, module starts to detect over current warning.
39	Over Current Warning Value	(0-200)%	110	When generator current has exceeded the set value and warning delay is expired, module will initiate over current warning alarm.
40	Over Current Warning Delay	(0-3600)s	3	Time duration from alarm is detected to it initiates alarm.
41	Over Current Trip Enabled	(0-1) 0: Disabled 1: Enabled	1	When it is enabled, module starts to detect over current trip.
42	Over Current Trip Value	(0-200)%	114	When generator current has exceeded the set value and trip delay is expired, module will initiate over current trip alarm.
43	Over Current Trip Delay	(0-3600)s	2	Time duration from alarm is detected to it initiates alarm.
44	Current Pre-alarm	(0-1) 0: Disabled 1: Enabled	1	When it is enabled, module starts to detect current pre-alarm.



No	Items	Range	Default	Description
45	Current Pre-alarm Value	(0-200)%	100	When current is over this value and lasts for the pre-set pre-alarm delay, module will initiate current pre-alarm.
46	Current Pre-alarm Delay	(0-3600)s	3	Time duration from alarm is detected to it initiates alarm.
47	Differential Current Warning Enabled	(0-1) 0: Disabled 1: Enabled	0	When this is enabled, module starts to detect differential current warning. NOTE: after enabled, controller only displays differential current information, while other measured data and alarms don't.
48	Differential Current Warning Value	(4-40)%	10	When current is over this value and has lasted for the preset warning delay, module will issue warning alarm.
49	Differential Current Warning Delay	(0-20.0)s	2.0	Time duration from alarm is detected to it initiates alarm.
50	Differential Current Trip Enabled	(0-1) 0: Disabled 1: Enabled	0	When this is enabled, module starts to detect differential current trip. NOTE: after enabled, controller only displays differential current information, while other measured data and alarms don't.
51	Differential Current Trip Value	(4-40)%	20	When current is over this value and has lasted for the preset trip delay, module will issue trip alarm.
52	Differential Current Trip Delay	(0-20.0)s	1.0	Time duration from alarm is detected to it initiates alarm.
Power Settings				
53	Rated Power	(0-6000)kW	276	It is generator's rated power, and used for provide standard for power alarm.
54	Rated Reactive Power	(0-6000)kvar	200	Generator's rated reactive power.
55	Over Power Warning Enabled	(0-1) 0: Disabled 1: Enabled	1	When it is enabled, module starts to detect over power warning.
56	Over Power Warning Value	(0-200)%	110	When active power (positive) has exceeded the set value and warning delay is expired, module will initiate over power warning alarm.
57	Over Power Warning Delay	(0-3600)s	3	Time duration from alarm is detected to it initiates alarm.
58	Over Power Trip Enabled	(0-1) 0: Disabled 1: Enabled	1	When it is enabled, module starts to detect over power trip.
59	Over Power Trip Value	(0-200)%	114	When active power (positive) has exceeded the set value and trip delay is expired, module will initiate over power trip alarm.



No	Items	Range	Default	Description
60	Over Power Trip Delay	(0-3600)s	2	Time duration from alarm is detected to it initiates alarm.
61	Reverse Power Warning Enabled	(0-1) 0: Disabled 1: Enabled	1	When it is enabled, module starts to detect reverse power warning.
62	Reverse Power Warning Value	(0-200)%	20	When reverse power (negative) has exceeded the set value and warning delay is expired, module will initiate reverse power warning alarm.
63	Reverse Power Warning Delay	(0-3600)s	3	Time duration from alarm is detected to it initiates alarm.
64	Reverse Power Trip Enabled	(0-1) 0: Disabled 1: Enabled	1	When it is enabled, module starts to detect reverse power trip.
65	Reverse Power Trip Value	(0-100)%	30	When reverse power (negative) has exceeded the set value and trip delay is expired, module will initiate reverse power trip alarm.
66	Reverse Power Trip Delay	(0-3600)s	2	Time duration from alarm is detected to it initiates alarm.
Outputs Settings				
67	Aux. Output 1 Setting	(0-30)	0	Default: not used
68	Aux. Output 1 Type	(0-1)	0	0: Normally open; 1: Normally close
69	Aux. Output 2 Setting	(0-30)	0	Default: not used
70	Aux. Output 2 Type	(0-1)	0	0: Normally open; 1: Normally close
71	Aux. Output 3 Setting	(0-30)	0	Default: not used
72	Aux. Output 3 Type	(0-1)	0	0: Normally open; 1: Normally close
73	Aux. Output 4 Setting	(0-30)	0	Default: not used
74	Aux. Output 4 Type	(0-1)	0	0: Normally open; 1: Normally close
Module Settings				
75	Module Address	(1-254)	1	Module address when remote monitoring control.
76	CANBUS Baud Rate	(0-1) 0: 250Kbps 1: 500Kbps 2: 125Kbps 3: 50Kbps	0	CANBUS communication baud rate configuration.
77	Language Selection	(0-1)	0	0: Simplified Chinese; 1: English
78	Password Setting	(0-9999)	00318	It is used to enter into parameter settings.

8.2 DEFINED CONTENTS OF PROGRAMMABLE OUTPUT PORTS 1~4







Table 11 Defined Contents of Programmable Output Ports 1-4

No.	Items	Description
0	Not Used	Output port is deactivated when "Not Used" is selected.
1	Common Alarm	Output when alarms occurred.
2	Common Warning Alarm	Output when warning alarms occurred.
3	Common Trip Alarm	Output when trip alarms occurred.
4	Over Volt Trip Alarm	Output when over voltage trip alarms occurred.
5	Under Volt Trip Alarm	Output when under voltage trip alarms occurred.
6	Loss of Phase Trip Alarm	Output when loss of phase trip alarms occurred.
7	Reverse Phase Sequence Trip Alarm	Output when reverse phase sequence trip alarm is occurred.
8	Over Frequency Trip Alarm	Output when over frequency trip alarm is occurred.
9	Under Frequency Trip Alarm	Output when under frequency trip alarm is occurred.
10	Over Current Trip Alarm	Output when over current trip alarm is occurred.
11	Over Current Pre-alarm	Output when over current pre-alarm is active.
12	Over Power Trip Alarm	Output when generator over power trip alarm is occurred.
13	Reserved	Reserved
14	Reverse Power Trip Alarm	Output when generator reverse power trip alarm is occurred.
15	Over Volt Warning	Output when generator over voltage warning alarm is occurred.
16	Under Volt Warning	Output when generator under voltage warning alarm is occurred.
17	Allow to Output On-load	Output when module meets the set on-load conditions.
18	Reserved	Reserved
19	Over Frequency Warning	Output when generator over frequency warning alarm is occurred.
20	Under Frequency Warning	Output when generator under frequency warning alarm is occurred.
21	Reserved	Reserved
22	Over Current Warning	Output when generator over current warning alarm is occurred.
23	Differential Protection Warning	Output when differential protection warning occurs.
24	Over Power Warning	Output when generator over power warning alarm is occurred.
25	Differential Protection Trip	Output when differential protection trip occurs.
26	Reverse Power Warning	Output when generator reverse power warning alarm is occurred.
27	Custom Output	Separately customized column A and column B output functions, when one is active, module will start output. Detailed to see Table 12 as bellow.
28	Reserved	Reserved
29	Reserved	Reserved
30	Reserved	Reserved

Table 12 Custom Output Port List

No.	Custom Output Column A	Custom Output Column B
00	Over Volt Warning Alarm	Over Volt Warning Alarm
01	Under Volt Warning Alarm	Under Volt Warning Alarm
02	Over Frequency Warning Alarm	Over Frequency Warning Alarm
03	Under Frequency Warning Alarm	Under Frequency Warning Alarm
04	Over Power Warning	Over Power Warning
05	Over Current Warning	Over Current Warning
06	Reverse Power Warning	Reverse Power Warning
07	Reverse Phase Sequence Trip Alarm	Reverse Phase Sequence Trip Alarm
08	Over Volt Trip Alarm	Over Volt Trip Alarm
09	Under Volt Trip Alarm	Under Volt Trip Alarm
10	Over Frequency Trip Alarm	Over Frequency Trip Alarm
11	Under Frequency Trip Alarm	Under Frequency Trip Alarm
12	Over Power Trip Alarm	Over Power Trip Alarm
13	Over Current Trip Alarm	Over Current Trip Alarm
14	Reverse Power Trip Alarm	Reverse Power Trip Alarm
15	Loss of Phase Trip Alarm	Loss of Phase Trip Alarm
16	Over Current Warning + Over Current Trip	Over Current Warning + Over Current Trip
17	Differential Protection Warning	Differential Protection Warning
18	Differential Protection Trip	Differential Protection Trip

9 PARAMETERS SETTING

After module is power up, press  to enter into the password screen. Input correct password (default password is "0318") to enter into the parameter setting menu and select parameter item via  and  buttons. Then press  to start setting.  is to increase value, and  is to decrease value. After the setting is finished, press  again to confirm it.

Parameters also can be set through PC software via SG72 module. Password is not needed for parameter setting on PC software. If it needs to set more parameters (such as voltage/current calibration) or the password is forgotten, please contact the factory.

NOTES:

- Over voltage set value must be higher than under voltage set value, otherwise over voltage and under voltage condition may occur simultaneously.
- For alarms not needed, please select "Disabled" in the alarm enabled selection.

10 TYPICAL APPLICATION

10.1 Module Typical Application

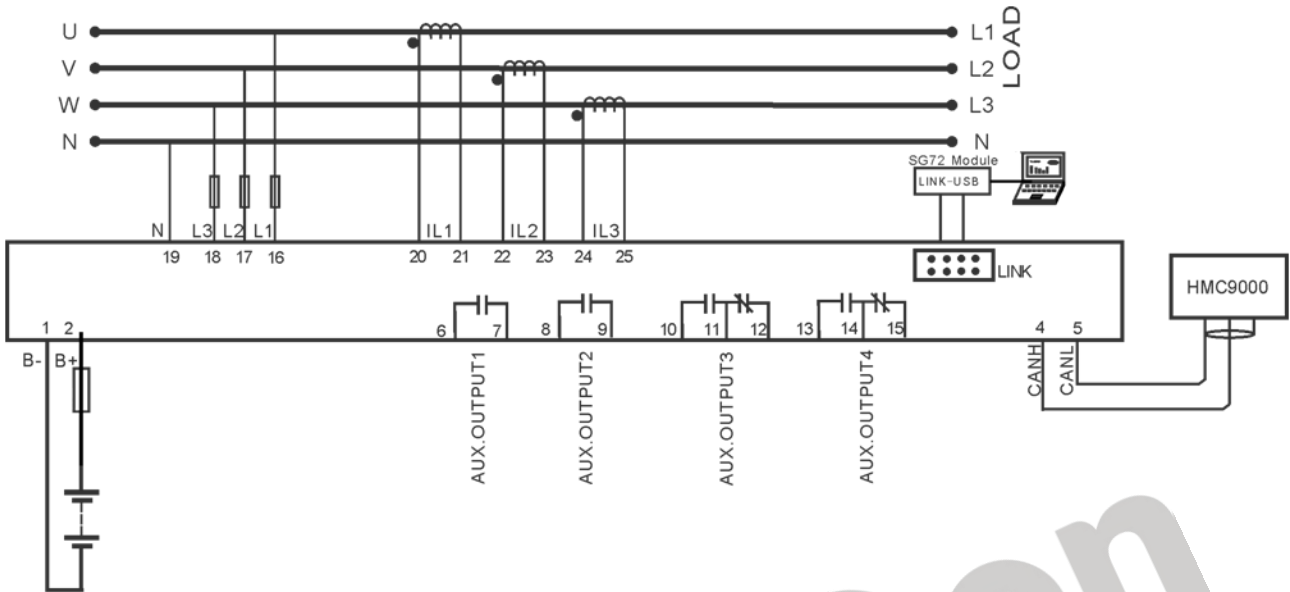

Fig. 2 HMP300 Typical Application Diagram

10.2 Differential Current Protection Application

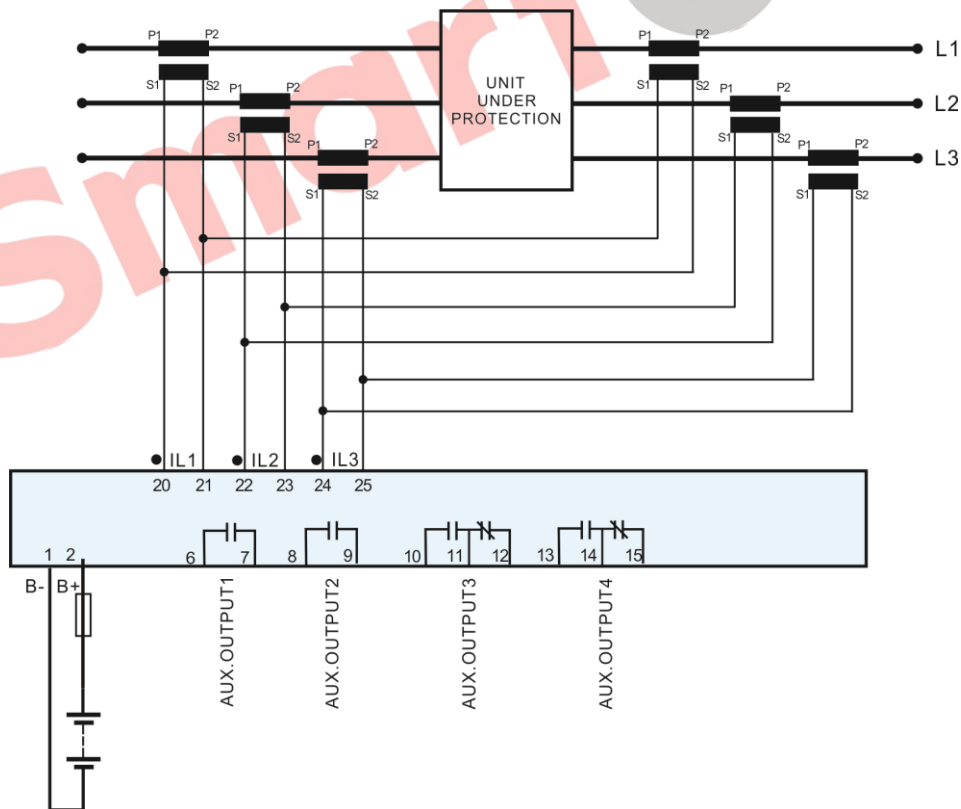

Fig. 3 Differential Protection Application Diagram

NOTE: CTs on the two sides must have same parameter characteristics, and cable load on the two sides also must be equal.

11 INSTALLATION

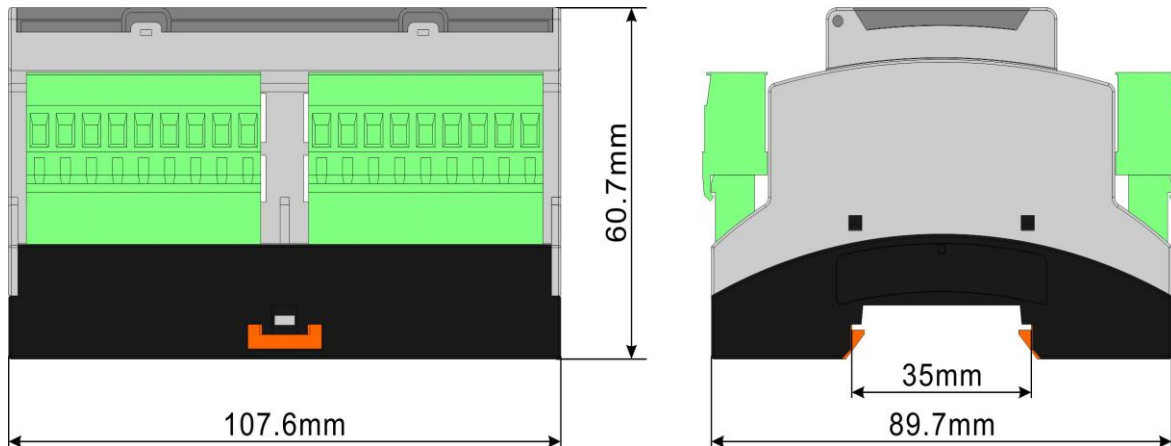

Fig. 4 Overall and Cutout Dimensions

ATTENTION:

– OUTPUT AND EXPAND RELAYS

All outputs of controller are relay contact output type. If it needs to expand the relays, please add freewheel diode to both ends of expand relay's coils (when coils of relay have DC current) or, increase resistance-capacitance return circuit (when coils of relay have AC current), in order to prevent disturbance for controller or other equipments.

– AC INPUT

Current input of controller must be connected to outside current transformer. And the current transformer's secondary current must be 5A. At the same time, the phases of current transformer and input voltage must be correct. Otherwise, the collected current and active power may be not correct.

NOTE: When there is load current, transformer's secondary side is prohibited to open circuit.

– WITHSTAND VOLTAGE TEST

When controller has been installed on control panel, if it needs the high voltage test, please disconnect controller's all terminal connections, in order to prevent high voltage going into controller and damaging it.