



SmartGen
ideas for power

AIN24-2

ANALOG INPUT MODULE

USER MANUAL

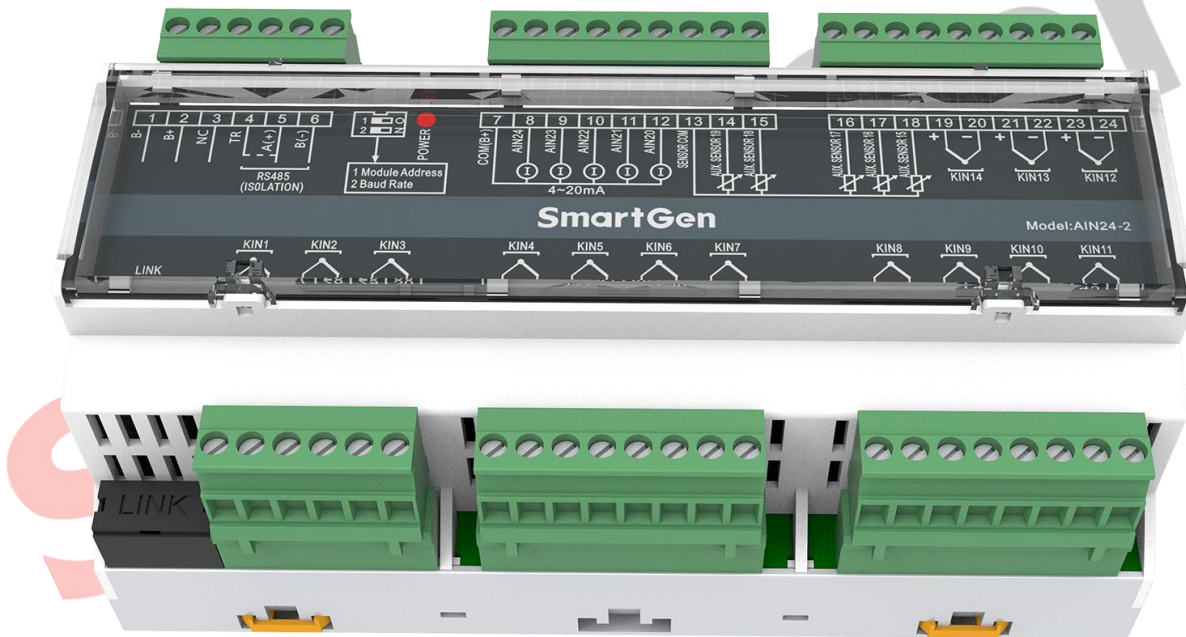

SMARTGEN (ZHENGZHOU) TECHNOLOGY CO.,LTD.



Chinese trademark

SmartGen English trademark

SmartGen – make your generator *smart*

SmartGen Technology Co., Ltd.

No.28 Jinsuo Road, Zhengzhou, Henan Province, China

Tel: +86-371-67988888/67981888/67992951

+86-371-67981000(overseas)

Fax: +86-371-67992952

Email: sales@smartgen.cn

Web: www.smartgen.com.cn

www.smartgen.cn



All rights reserved. No part of this publication may be reproduced in any material form (including photocopying or storing in any medium by electronic means or other) without the written permission of the copyright holder.

SmartGen Technology reserves the right to change the contents of this document without prior notice.

Table 1 – Software Version

Date	Version	Content
2021-10-26	1.0	Original release.

Table 2 – Notation Clarification

Symbol	Instruction
 NOTE	Highlights an essential element of a procedure to ensure correctness.
 CAUTION	Indicates a procedure or practice, which, if not strictly observed, could result in damage or destruction of equipment.
 WARNING	Indicates a procedure or practice, which could result in injury to personnel or loss of life if not followed correctly.



CONTENTS

1	OVERVIEW	4
2	PERFORMANCE AND CHARACTERISTICS.....	4
3	TECHNICAL PARAMETERS.....	4
4	WIRE CONNECTION.....	5
5	ELECTRICAL CONNECTION DIAGRAM	7
6	CASE DIMENSIONS	7
7	TROUBLE SHOOTING	7

SmartGen

1 OVERVIEW

AIN24-2 Analog Input Module is a module which has 14-way K-type thermocouple sensor, 5-way resistance type sensor and 5-way (4-20)mA current type sensor. The sampling data are transmitted to the master controller via RS485 port.

2 PERFORMANCE AND CHARACTERISTICS

- With 32-bit ARM based SCM, high integration of hardware and more reliable;
- Must be used with master controller together;
- RS485 communication baud rate can be set as 9600bps or 19200bps via dial switch;
- Module address can be set as 1 or 2;
- Wide power supply range DC(8~35)V, suitable to different battery voltage environment;
- 35mm guide rail mounting type;
- Modular design, pluggable terminal, compact structure and easy installation.

3 TECHNICAL PARAMETERS

Table 3 – Technical Parameters

Item	Content
Working Voltage	DC(8~35)V, continuous power supply
Power Consumption	<0.5W
K-type Thermocouple Measurement Accuracy	1°C
(4-20)mA Current Measurement Accuracy	Class 1
Case Dimension	161.6mm x 89.7mm x 60.7mm
Rail Dimension	35mm
Working Temperature	(-25~+70)°C
Working Humidity	(20~93)%RH
Storage Temperature	(-40~+80)°C
Weight	0.33kg



4 WIRE CONNECTION

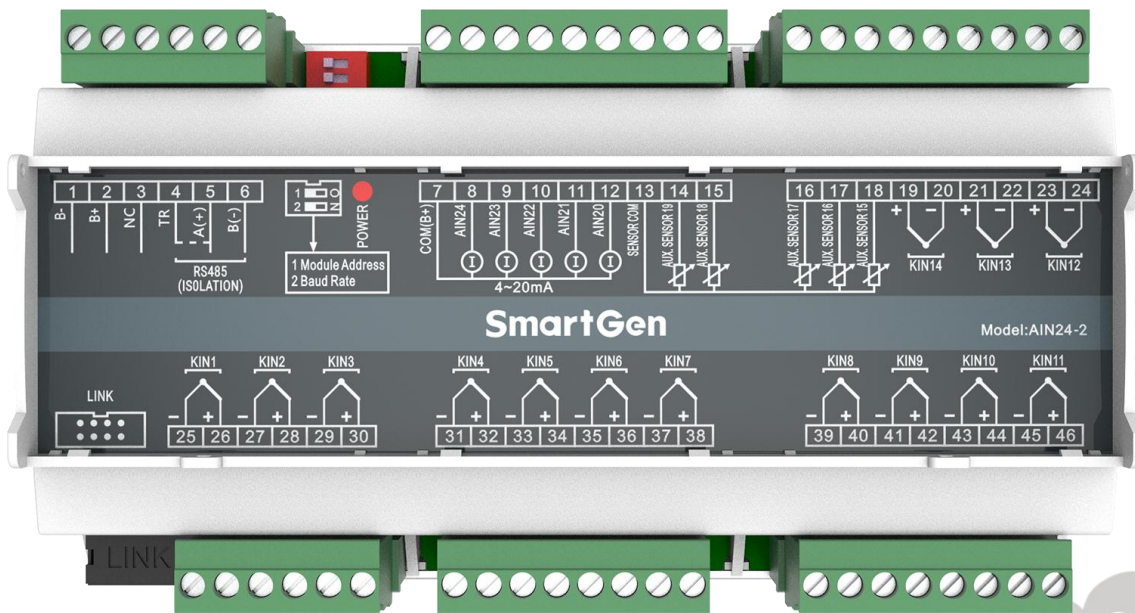

Fig. 1 – AIN24-2 Panel Drawing

Table 4 – Terminal Connection

No.	Function	Cable Size	Description
1	B-	1.0mm ²	DC power supply negative input.
2	B+	1.0mm ²	DC power supply positive input.
3	NC		No Contact.
4	TR	0.5mm ²	Short connect Terminal 4 and Terminal 5 if the matched resistance is required.
5	RS485 A(+)	0.5mm ²	The RS485 port for communication with master controller. 120Ω shielding wire with its one end grounded is recommended.
6	RS485 B(-)		
7	COM (B+)	1.0mm ²	4-20mA current sensor COM terminal (B+)
8	AIN24	0.5mm ²	4-20mA current sensor terminal
9	AIN23	0.5mm ²	4-20mA current sensor terminal
10	AIN22	0.5mm ²	4-20mA current sensor terminal
11	AIN21	0.5mm ²	4-20mA current sensor terminal
12	AIN20	0.5mm ²	4-20mA current sensor terminal
13	SENSOR COM	0.5mm ²	Resistance sensor COM terminal (B+)
14	AUX.SENSOR 19	0.5mm ²	Resistance sensor terminal
15	AUX.SENSOR 18	0.5mm ²	Resistance sensor terminal
16	AUX.SENSOR 17	0.5mm ²	Resistance sensor terminal
17	AUX.SENSOR 16	0.5mm ²	Resistance sensor terminal
18	AUX.SENSOR 15	0.5mm ²	Resistance sensor terminal
19	KIN14+	0.5mm ²	"K-type" thermocouple sensor
20	KIN14-		



No.	Function	Cable Size	Description
21	KIN13+	0.5mm ²	"K-type" thermocouple sensor
22	KIN13-		
23	KIN12+	0.5mm ²	"K-type" thermocouple sensor
24	KIN12-		
25	KIN1-	0.5mm ²	"K-type" thermocouple sensor
26	KIN1+		
27	KIN2-	0.5mm ²	"K-type" thermocouple sensor
28	KIN2+		
29	KIN3-	0.5mm ²	"K-type" thermocouple sensor
30	KIN3+		
31	KIN4-	0.5mm ²	"K-type" thermocouple sensor
32	KIN4+		
33	KIN5-	0.5mm ²	"K-type" thermocouple sensor
34	KIN5+		
35	KIN6-	0.5mm ²	"K-type" thermocouple sensor
36	KIN6+		
37	KIN7-	0.5mm ²	"K-type" thermocouple sensor
38	KIN7+		
39	KIN8-	0.5mm ²	"K-type" thermocouple sensor
40	KIN8+		
41	KIN9-	0.5mm ²	"K-type" thermocouple sensor
42	KIN9+		
43	KIN10-	0.5mm ²	"K-type" thermocouple sensor
44	KIN10+		
45	KIN11-	0.5mm ²	"K-type" thermocouple sensor
46	KIN11+		
	SWITCH	The master controller can connect to two AIN24-2 modules at the same time. Address selection: It is module 1 when the switch 1 is connected to 12 while module 2 when connect to ON position. Baud rate selection: It is 9600bps when the switch 2 is connected to 12 while 19200bps when connect to ON position.	
	POWER	Power supply normal indicator; It is flashing when the communication is abnormal for over 10s.	

5 ELECTRICAL CONNECTION DIAGRAM

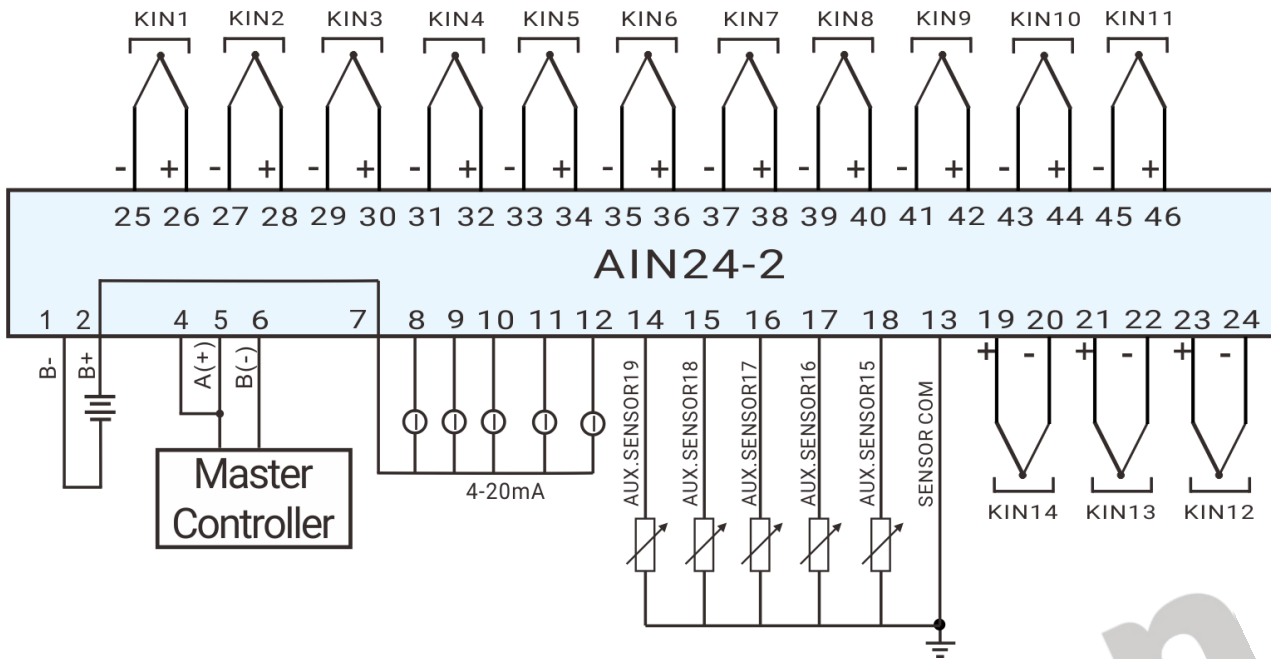

Fig.2 – AIN24-2 Electrical Connection Diagram

6 CASE DIMENSIONS

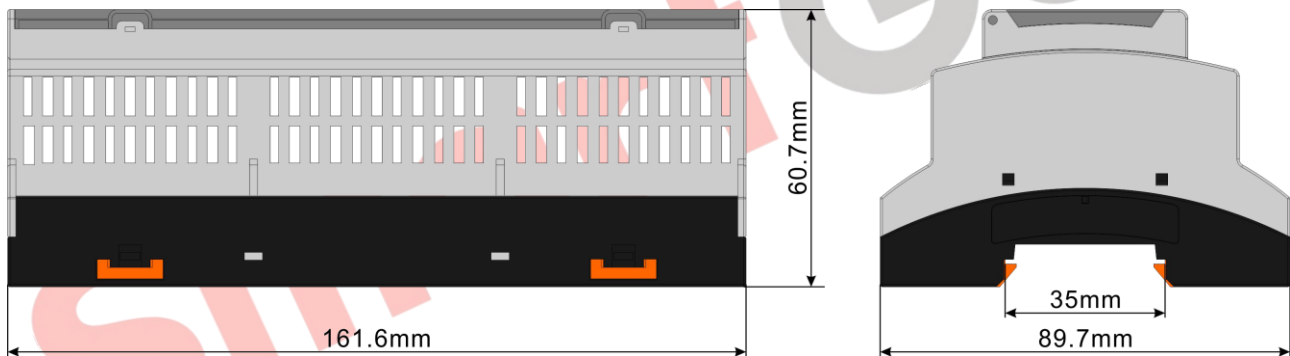

Fig.3 – Overall Dimensions

7 TROUBLE SHOOTING

Table 5 – Troubleshooting

Problem	Possible Solution
Controller no response with power	Check power voltage; Check controller connection wirings; Check DC fuse.
RS485 communication failure	Check if RS485 wires are connected correctly.