

# SmartGen

MAKING CONTROL SMARTER

## AIN16-C-2

### ANALOG INPUT MODULE

### USER MANUAL

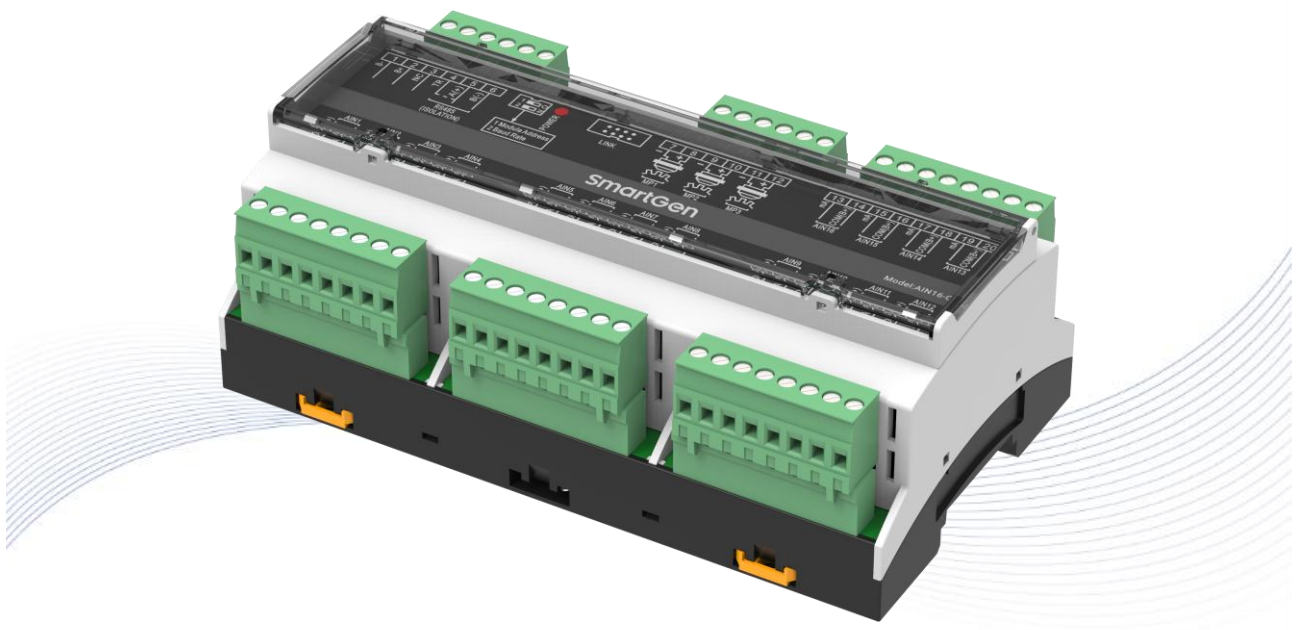

郑州众智科技股份有限公司  
SMARTGEN(ZHENGZHOU)TECHNOLOGY CO.,LTD.

SmartGen – make your generator *smart*

SmartGen Technology Co., Ltd.

No.28 Xuemei Street, Zhengzhou, Henan, China

Tel: +86-371-67988888/67981888/67992951

+86-371-67981000(overseas)

Fax: +86-371-67992952

Email: [sales@smartgen.cn](mailto:sales@smartgen.cn)

Web: [www.smartgen.com.cn](http://www.smartgen.com.cn)

[www.smartgen.cn](http://www.smartgen.cn)

All rights reserved. No part of this publication may be reproduced in any material form (including photocopying or storing in any medium by electronic means or other) without the written permission of the copyright holder.

Applications for the copyright holder's written permission to reproduce any part of this publication should be addressed to Smartgen Technology at the address above.



Any reference to trademarked product names used within this publication is owned by their respective companies.

SmartGen Technology reserves the right to change the contents of this document without prior notice.

**Table 1 - Software Version**

Date	Version	Content
2021-09-10	1.0	Original release.
2022-11-16	1.1	Update the logo of SmartGen.

**Table 2 - Notation Clarification**

Symbol	Instruction
 NOTE	Highlights an essential element of a procedure to ensure correctness.
 CAUTION	Indicates a procedure or practice, which, if not strictly observed, could result in damage or destruction of equipment.
 WARNING	Indicates a procedure or practice, which could result in injury to personnel or loss of life if not followed correctly.

## CONTENTS

1	OVERVIEW.....	3
2	PERFORMANCE AND CHARACTERISTICS.....	4
3	TECHNICAL PARAMETERS.....	4
4	CONNECTION.....	5
5	TYPICAL APPLICATION .....	7
6	CASE DIMENSIONS .....	8
7	TROUBLE SHOOTING .....	8

SmartGen

### 1 OVERVIEW

**AIN16-C-2 Analog Input Module** is a module which has 16 channels of 4mA-20mA sensor input and 3 channels of speed sensor input. The 4mA-20mA data and speed data are transmitted to the master controller for processing via RS485 port. Different alarm threshold values can be set for each

sensor via master controller.

## 2 PERFORMANCE AND CHARACTERISTICS

- With 32-bit ARM based SCM, high integration of hardware and more reliable;
- Must be used with master controller together;
- RS485 communication baud rate can be set as 9600bps or 19200bps via dial switch;
- Module address can be set as 1 or 2 via dial switch;
- Wide power supply range DC(18~35)V, suitable to different battery voltage environment;
- 35mm guide rail mounting type;
- Modular design, pluggable terminal, compact structure and easy installation.

## 3 TECHNICAL PARAMETERS

**Table 3 – Technical Parameters**

Item	Content
Working Voltage Range	DC18.0V~35.0V
Power Consumption	<0.5W
Input Sensor Type	(4-20)mA Current Type
Measurement Accuracy	Class 0.5
RS485 Communication Parameter	Baud rate: 9600bps, Stop bit: 2-bit, Data bit: 8-bit, Parity bit: no parity
Case Dimension	161.6mm x 89.7mm x 60.7mm
Rail Dimension	35mm
Working Temperature	(-25~+70)°C
Working Humidity	(20~93)%RH
Storage Temperature	(-30~+80)°C
Weight	0.33kg

4 CONNECTION

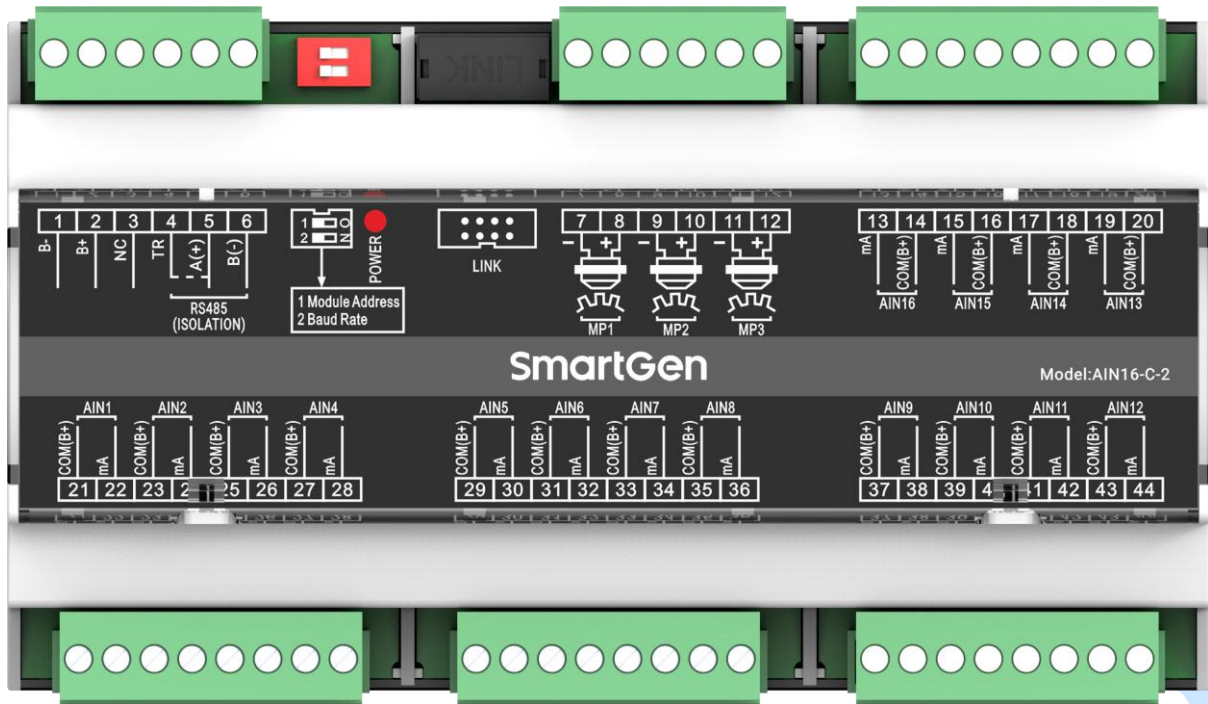

Fig.1 – AIN16-C-2 Panel Drawing

Table 4 – Terminal Connection

No.	Function	Cable Size	Description
1	B-	1.0mm <sup>2</sup>	DC power supply negative input.
2	B+	1.0mm <sup>2</sup>	DC power supply positive input.
3	NC		No Contact.
4	120Ω Terminal Matched Resistance	0.5mm <sup>2</sup>	Short connect Terminal 4 and Terminal 5 if the matched resistance is required.
5	A(+)	0.5mm <sup>2</sup>	The RS485 port for communication with master controller.
6	B(-)		
7	MP1(-)	0.5mm <sup>2</sup>	Connect with speed sensor (shielded wire is recommended). Speed sensor input (-), B- has been connected in the controller.
8	MP1(+)	0.5mm <sup>2</sup>	
9	MP2(-)	0.5mm <sup>2</sup>	Connect with speed sensor (shielded wire is recommended). Speed sensor input (-), B- has been connected in the controller.
10	MP2(+)	0.5mm <sup>2</sup>	
11	MP3(-)	0.5mm <sup>2</sup>	Connect with speed sensor (shielded wire is recommended). Speed sensor input (-), B- has been connected in the controller.
12	MP3(+)	0.5mm <sup>2</sup>	
13	AIN16(mA)	0.5mm <sup>2</sup>	(4-20)mA analog input.

No.	Function	Cable Size	Description
14	AIN16(Com(B+))		B+ voltage output (provide power supply for pressure transmitter).
15	AIN15(mA)	0.5mm <sup>2</sup>	(4-20)mA analog input.
16	AIN15(Com(B+))		B+ voltage output (provide power supply for pressure transmitter).
17	AIN14(mA)	0.5mm <sup>2</sup>	(4-20)mA analog input.
18	AIN14(mA)		B+ voltage output (provide power supply for pressure transmitter).
19	AIN13(mA)	0.5mm <sup>2</sup>	(4-20)mA analog input.
20	AIN13(Com(B+))		B+ voltage output (provide power supply for pressure transmitter).
21	AIN1(Com(B+))	0.5mm <sup>2</sup>	B+ voltage output (provide power supply for pressure transmitter).
22	AIN1(mA)		(4-20)mA analog input.
23	AIN2(Com(B+))	0.5mm <sup>2</sup>	B+ voltage output (provide power supply for pressure transmitter).
24	AIN2(mA)		(4-20)mA analog input.
25	AIN3(Com(B+))	0.5mm <sup>2</sup>	B+ voltage output (provide power supply for pressure transmitter).
26	AIN3(mA)		(4-20)mA analog input.
27	AIN4(Com(B+))	0.5mm <sup>2</sup>	B+ voltage output (provide power supply for pressure transmitter).
28	AIN4(mA)		(4-20)mA analog input.
29	AIN5(Com(B+))	0.5mm <sup>2</sup>	B+ voltage output (provide power supply for pressure transmitter).
30	AIN5(mA)		(4-20)mA analog input.
31	AIN6(Com(B+))	0.5mm <sup>2</sup>	B+ voltage output (provide power supply for pressure transmitter).
32	AIN6(mA)		(4-20)mA analog input.
33	AIN7(Com(B+))	0.5mm <sup>2</sup>	B+ voltage output (provide power supply for pressure transmitter).
34	AIN7(mA)		(4-20)mA analog input.
35	AIN8(Com(B+))	0.5mm <sup>2</sup>	B+ voltage output (provide power supply for pressure transmitter).
36	AIN8(mA)		(4-20)mA analog input.
37	AIN9(Com(B+))	0.5mm <sup>2</sup>	B+ voltage output (provide power supply for pressure transmitter).
38	AIN9(mA)		(4-20)mA analog input.
39	AIN10(Com(B+))	0.5mm <sup>2</sup>	B+ voltage output (provide power supply for pressure transmitter).
40	AIN10(mA)		(4-20)mA analog input.

No.	Function	Cable Size	Description
41	AIN11(Com(B+))	0.5mm <sup>2</sup>	B+ voltage output (provide power supply for pressure transmitter).
42	AIN11(mA)		(4-20)mA analog input.
43	AIN12(Com(B+))	0.5mm <sup>2</sup>	B+ voltage output (provide power supply for pressure transmitter).
44	AIN12(mA)		(4-20)mA analog input.
	SWITCH		Address selection: It is module 1 when the switch 1 is connected to terminal 12 while module 2 when connect to ON terminal. Baud rate selection: It is 9600bps when the switch 2 is connected to terminal 12 while 19200bps when connect to ON terminal.
	POWER		Power supply and communication normal indicator; It is flashing when the communication is abnormal, it is always illuminated when communication is normal.
	LINK		System upgrade port; modify the default parameters.

## 5 TYPICAL APPLICATION

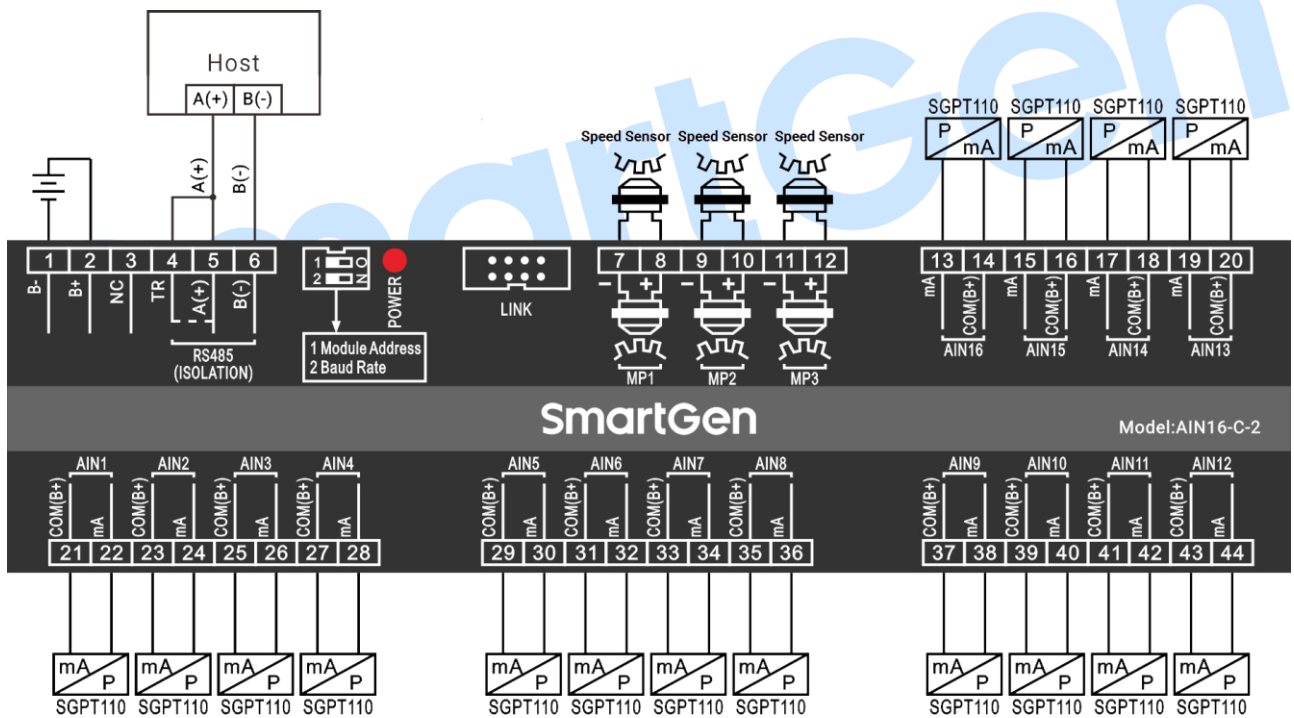

**Fig.2 – AIN16-C-2 Typical Application Diagram**

**6 CASE DIMENSIONS**

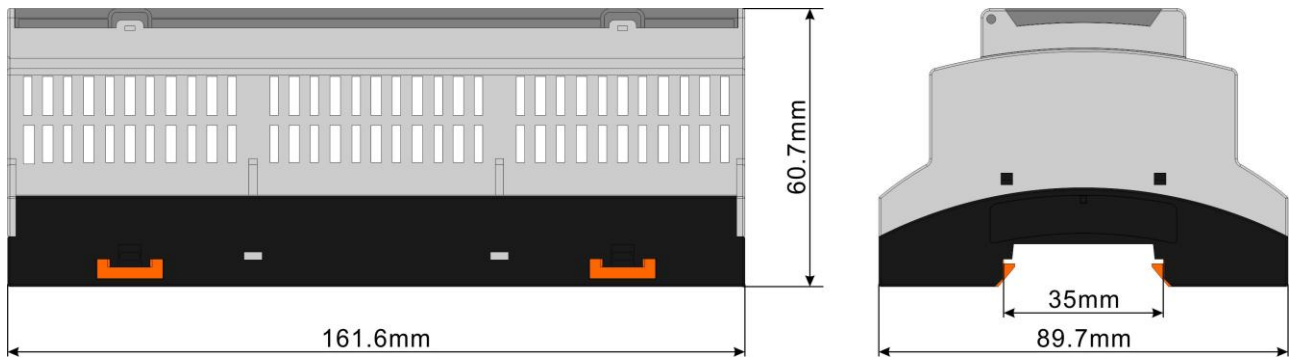

**Fig.3 – Overall Dimensions**

**7 TROUBLE SHOOTING**

Problem	Possible Solution
Controller no response with power	Check starting batteries; Check controller connection wirings;
RS485 communication failure	Check if RS485 wires are connected correctly; Check if 120Ω resistance is connected; Check if the baud rate and stop-bit of master controller are correct.