

SmartGen

MAKING CONTROL SMARTER

HEM8400 ENGINE CAN MONITORING CONTROLLER USER MANUAL



郑州众智科技股份有限公司
SMARTGEN(ZHENGZHOU)TECHNOLOGY CO.,LTD.

SmartGen 众智 Chinese trademark

SmartGen English trademark

SmartGen – make your generator *smart*

SmartGen Technology Co., Ltd.

No.28 Jinsuo Road, Zhengzhou, Henan Province, China

Tel: +86-371-67988888/67981888/67992951

+86-371-67981000(overseas)

Fax: +86-371-67992952

Web: www.smartgen.com.cn/

www.smartgen.cn/

Email: sales@smartgen.cn

All rights reserved. No part of this publication may be reproduced in any material form (including photocopying or storing in any medium by electronic means or other) without the written permission of the copyright holder.

Applications for the copyright holder’s written permission to reproduce any part of this publication should be addressed to SmartGen Technology at the address above.

Any reference to trademarked product names used within this publication is owned by their respective companies.



SmartGen Technology reserves the right to change the contents of this document without prior notice.

Table 1 Software Version

Date	Version	Content
2019-03-21	2.0	Initial release
2020-01-03	2.1	Fix a character.
2020-04-09	2.2	1. Add J1939 examples of controller and engine connection; 2. Update controller design sketch and case dimension drawing.
2020-04-15	2.3	Fix part of cable size.
2020-10-19	2.4	1. Modify the output port name of the controller in the example of J1939 connection between the controller and engine; 2. Add the example of connection between the controller and Weichai WISE15 electric-controlled engine.
2021-03-02	2.5	Modify translation problems and format.
2022-07-27	2.6	1. Update company logo; 2. Add input port: local/remote control, local (remote CAN2) description; 3. Add output port: preheat output description; 4. Add description of high temperature protection setting (ECU), low

Date	Version	Content
		oil pressure protection setting (ECU), shutdown inhibit enable, ECU communication address, throttle idle speed enable, boot screen enable and mode selection.

Table 2 Symbol Instruction

Symbol	Instruction
 NOTE	Highlights an essential element of a procedure to ensure correctness.
 CAUTION	Indicates a procedure or practice, which, if not strictly observed, could result in damage or destruction of equipment.
 WARNING	Indicates a procedure or practice, which could result in injury to personnel or loss of life if not followed correctly.

SmartGen

CONTENTS

1	OVERVIEW.....	5
2	PERFORMANCE AND CHARACTERISTICS.....	5
3	SPECIFICATION	6
4	OPERATION.....	7
4.1	KEY FUNCTION DESCRIPTION	7
4.2	CONTROLLER PANEL.....	8
5	LCD DISPLAY	9
5.1	MAIN DISPLAY.....	9
5.2	USER MENU AND PARAMETER SETTINGS.....	12
5.3	START/STOP OPERATION.....	14
5.4	SPEED REGULATION OPERATION.....	15
5.5	ENGINE DIAGNOSIS OPERATION	16
6	PROTECTIONS	17
6.1	WARNING ALARMS.....	17
6.2	SHUTDOWN ALARMS	18
7	WIRING CONNECTION.....	19
8	SCOPES AND DEFINITIONS OF PROGRAMMABLE PARAMETERS.....	22
8.1	CONTENTS AND SCOPES OF PARAMETERS.....	22
8.2	DEFINABLE CONTENTS OF AUXILIARY OUTPUT PORT 1-2.....	27
8.3	DEFINABLE CONTENTS OF DIGITAL INPUT PORTS.....	29
8.4	SENSORS SELECTION.....	31
9	SENSORS SETTING.....	32
10	TYPICAL APPLICATION	33
11	INSTALLATION	34
11.1	FIXING CLIPS.....	34
11.2	OVERALL DIMENSION AND PANEL CUTOUT	34
12	CONNECTIONS OF CONTROLLER AND J1939 ENGINE.....	35
12.1	CUMMINS QSL9	35
12.2	CUMMINS QSX15-CM570	35
12.3	CUMMINS QSM11.....	36
12.4	DETROIT DIESEL DDEC III/IV	36
12.5	MTU ADEC (SMART MODULE).....	36
12.6	MTU ADEC (SAM MODULE).....	37
12.7	SCANIA.....	37
12.8	WEICHAJ.....	37
12.8.1	BOSCH COMMON RAIL ELECTRIC-CONTROLLED ENGINE.....	37
12.8.2	WISE15 ELECTRIC-CONTROLLED ENGINE	38
13	FAULT FINDING	39

1 OVERVIEW

HEM8400 Engine CAN Monitoring Controller is an intelligent instrument and controlling device that combined microelectronic technique, electric measurement technique, digital-analog hybrid signal processing technique, CAN communication technique, vehicle controlling technique and engine electronic control technique. It is the ideal product for engineering vehicles' CAN communication and electric device control with its high integration and powerful CAN gateway functions (can replace Murphy display totally).

2 PERFORMANCE AND CHARACTERISTICS

- With 32-bit ARM microprocessor as the core, 4.3-inch LCD display, touch buttons operation and English/Chinese language can be selected;
- Two CANBUS ports, one is connecting with engine ECU, and the other one is standby;
- RS485 communication port enables data communication via ModBus protocol through PC software;
- Through CANBUS port can read real time data of engine, such as speed, water temperature, oil pressure, oil temperature, total fuel consumption and instant fuel consumption;
- With a reset zero button for integrated panel engine, press and hold it for more than 3s to reset subtotal time and fuel consumption;
- With a fault diagnosis button for integrated panel engine, press it enter into diagnostic mode, if ECU alarms occur in this mode, users can check corresponding fault alarm information through flicker times of engine red light, and press it again to exit diagnostic mode;
- Hand throttle switch: push button on the panel, press it after engine start to activate hand throttle, which can accurately control engine speed;
- With J1939 international standard 9-pin engine diagnostic port;
- Users can change parameters settings, and changed parameters will be memorized into internal FLASH storage simultaneously to avoid losing data if power down;
- Real-time calendar, RTC, and running time accumulation functions;
- Diesel engine total start times display;
- 99 pieces of shutdown alarm records can be cyclic stored and records can be checked on the site;
- Use hard screen acrylic material to protect screen with strong wear-resistance and scratch resistance;
- Rubber panel and buttons with strong performance to work in high/low temperature;
- Widely power supply range (10~35) VDC, which can adapt to various starting battery voltage environments;
- There is rubber seal ring between shell and control panel. IP65 protective performance can achieve.

3 SPECIFICATION











Table 3 Technical Parameters

Parameter	Details
Working Voltage	DC10.0V to 35.0V, uninterruptible power supply
Overall Consumption	<5W (Standby mode: ≤3.5W)
Crank Relay Output	16A DC28V power supply output
ECU Power Relay Output	16A DC28V power supply output
Programmable Relay Output 1-2	7A DC28V power supply output
Analog Sensor	Resistance Input Range: 0-6000Ω Resolution: 0.1 Accuracy: 1Ω (below 300Ω)
Case Dimension	247mm × 191mm × 71mm
Panel Cutout	214mm × 160mm
Mounting Screw Dimension	Φ4
Working Temperature	(-25~+70)°C
Working Humidity	(20~93)%RH
Storage Temperature	(-25~+70)°C
Protection Level	IP65 front panel
Weight	0.90kg
Insulation Intensity	Apply AC2.2kV voltage between high voltage terminal and low voltage terminal. The leakage current is not more than 3mA within 1min.

4 OPERATION

4.1 KEY FUNCTION DESCRIPTION

Table 4 Key Function Description





Icons	Keys	Description
	Stop	Stop the running engine; Reset shutdown alarms when engine alarms occur.
	Start	Start engine in standby status.
	Power	In standby status, press and hold this key to turn off the power; In power off status, press and hold this key to turn on the power.
Diag	Diagnosis	It can put the controller in diagnostic mode, and its indicator lights up; Press it again and it exits diagnostic mode, and its indicator lights off.
	Paging Up	In Diagnostic mode, if multiple ECU alarms occur, it can check the flashing status of the last alarm.
	Paging Down	In Diagnostic mode, if multiple ECU alarms occur, it can check the flashing status of the next alarm.
on/off	Hand Throttle Control	After the engine starts, it can put the engine in hand throttle mode, its indicator lights up, and speed can be adjusted on throttle knob. Press it again and the engine exits hand throttle mode, its indicator lights off, and speed cannot be adjusted at this moment.
	Zero Clearing	Press it for more than 3s and "subtotal time", "subtotal fuel consumption" and "subtotal avg. fuel consumption" become "0".
	Home/Set	In main menu page, it can enter parameter setting interface; in other pages, it can make it faster to return the main menu page.
	Up/Increase	1) Screen scroll; 2) Move up cursor and increase value in setting menu.
	Down/Decrease	1) Screen scroll; 2) Move down cursor and decrease value in setting menu.
	Throttle Knob	In hand throttle mode, forward/backward rotate this knob to increase/decrease target speed; Press the knob and it can return to 'Idle Speed'.

4.2 CONTROLLER PANEL



Fig.1 HEM8400 Front Panel Indication

Table 5 Indicator Description

Indicators	Description
	Engine shutdown alarm indication, when diagnostic mode is active, if ECU alarms occur, users can check corresponding fault alarm information through flicker times of this indicator. (engine red light)
	Engine warning alarm indication, when controller detects warning alarm signals, this indicator flashes. (engine yellow light)
	Engine waiting for start indication, when engine preheat starts, ECU initiates corresponding preheat command.
	Charging indication, after charging indication input accessing to the controller, when charge, it will light off, otherwise, it will light on.

5 LCD DISPLAY

5.1 MAIN DISPLAY

When system power is connected (controller has no power right now), press power key  for more than 2s, then controller starts power up, right now, after entering boot password, controller will get into normal running interface as bellow:

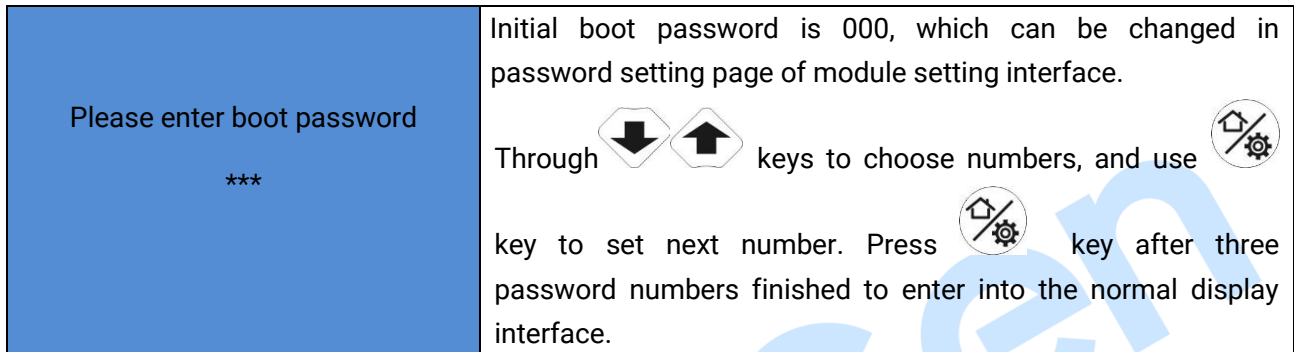
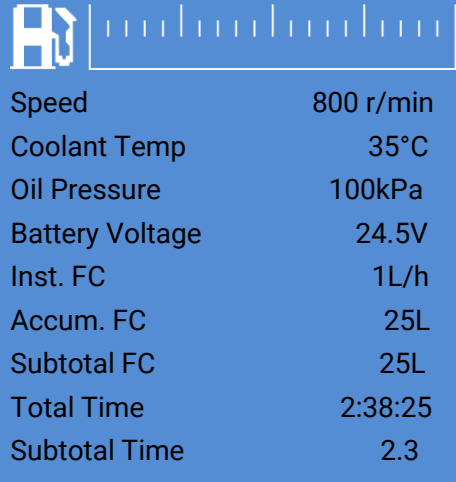

Fig.2 Start Interface

Interface display can be divided into multi pages: Main Screen display, Engine Data display, Alarm Data display, Event log Data display, and Others information display.

- **Main Screen** includes the following contents:

Table 6 Display Content Description

Main Screen Display Content		
Display Content	Description	Data Sources
	Engine fuel level indication	Fuel level sensor data
	Engine running speed	ECU data analysis
	Engine coolant temp display	ECU data analysis
	Engine oil pressure display	ECU data analysis
	System power supply volt	Controller gathered battery volt.
	Engine instant fuel consump.	ECU data analysis
	Engine total fuel consump.	ECU data analysis
	Fuel used after engine start	FC calculation after engine start
	Total engine running time	Engine run time accumulation
	Running time after engine start	Time accumulation after engine start
	Oil filter running time	Run time after new oil filter changed
	Diesel filter running time	Run time after new diesel filter changed.
	At Rest	Engine status
Engine Page Display Content		
Display	Description	Data Sources
Engine		
Oil Pressure Sensor	68kPa	
Water Temp Sensor	65°C	Oil temp display
Oil Temp	25°C	Fuel temp display
Fuel Temp	25°C	Fuel pressure display
Fuel Pressure	100kPa	Inlet temp display
Inlet Temp	25°C	Outlet temp display
Outlet Temp	25°C	Turbo pressure display
Turbo Pressure	100kPa	Coolant pressure display
Coolant Pressure	30kPa	Coolant level sensor display
Coolant Level	80%	ECU data analysis
Subtotal Avg FC	5L/h	Subtotal avg. FC display
Starts	12	Start times display
		Start times accumulation

NOTE: Different engines contain different data.

- **Alarm** page concludes:
Display all warnings and shutdown information.

NOTE: For ECU alarms and shutdown alarms, which can display most of alarms content and SPN codes, if the alarm information that not been displayed, please check the engine manual according to SPN alarm code.

- **Event log** page concludes:
Make records about all alarms and the real time when alarm occurs.
- **Others** page concludes:
Time and date, software version, hardware version, input/output status.

SmartGen

5.2 USER MENU AND PARAMETER SETTINGS

Press  key and enter user menu:

- Parameter

After entering the correct password (factory default password is 00318) you can enter parameter settings interface.

- Module settings
- Timer settings
- Engine settings
- Sensor settings (flexible sensor 1-2, fuel level sensor setting)
- Input port settings
- Output port settings
- ECU info display settings

Table 7 Parameter Setting Example (Screen 1)



<ul style="list-style-type: none"> >Return >Module Settings <li style="background-color: #0070C0; color: white;">>Timer Settings >Engine Settings >Sensor Settings >Input Port Settings >Output Port Settings >ECU Info Display Settings 	<p>Screen 1:</p> <p>Use   to change settings and  to enter settings (Screen 2).</p>
<ul style="list-style-type: none"> >Return >Pre-heat Delay >Cranking Time >Crank Rest Time >Safety On Time >Cooling Time >ETS Solenoid Hold >Fail to Stop Delay >Power Off Delay 	

Table 8 Parameter Setting Example (Screen 2)



<ul style="list-style-type: none"> >Return >Module Settings >Timers Settings >Engine Settings >Sensor Settings >Input Port Settings >Output Port Settings 	<p>Screen 2:</p> <p>Use   to change settings and  to enter settings (Screen 3).</p>
<ul style="list-style-type: none"> >Return <li style="background-color: #D3D3D3;">>Pre-heat Delay >Cranking Time >Crank Rest Time >Safety On Delay >Cooling Time >ETS Solenoid Hold >Fail to Stop Delay >Power Off Delay 	

Table 9 Parameter Setting Example (Screen 3)







<ul style="list-style-type: none"> >Return <li style="background-color: #D3D3D3;">>Pre-heat Delay >Cranking Time >Crank Rest Time >Safety On Delay >Cooling Time >ETS Solenoid Hold >Fail to Stop Delay >Power Off Delay 	<p>Screen 3:</p> <p>Use   to change settings and  to enter settings (Screen 3).</p>
<p>00010s</p>	

Table 10 Parameter Setting Example (Screen 4)

<ul style="list-style-type: none"> >Return >Pre-heat Delay >Cranking Time >Crank Rest Time >Safety On Delay >Cooling Time >ETS Solenoid Hold >Fail to Stop Delay >Power Off Delay 	<p>Screen 4:</p> <p>Use   to change settings and  to move setting numbers and confirm setting data.</p>
<p>00010s</p>	

NOTE: press  and it can exist parameter settings directly.

5.3 START/STOP OPERATION

- a) Press start key, then engine is cranking.
- b) Preheat relay energizes (if configured), “preheat delay XX s” information will be displayed on LCD;
- c) After the preheat delay, starting relay is engaged. If the engine fails to fire during this cranking attempt then the starting relay stop outputting; “crank rest time” begins and wait for the next crank attempt.
- d) Should this start sequence continue beyond the set number of attempts, the start sequence will be terminated, and crank failure alarm will be initiated.
- e) In case of successful crank attempt, the “safety on” timer is activated. As soon as this delay is over, engine enters into normal running status.
- f) During the engine normal running process, when hand throttle is active, users can adjust engine speed through hand throttle knob.
- g) Press stop key, engine enters into stopping process.
- h) Engine enters “ETS solenoid hold”. ECU power off and ETS delay timer is energized.
- i) After ETS delay is over, it enters into “after stop” delay.
- j) Engine is placed into its standby mode after its “wait for stop” delay expired.

5.4 SPEED REGULATION OPERATION

a) After controller normal running, press **on/off** key (hand throttle is active), controller's main screen is showing as bellow,



 	
Speed	800 r/min
Coolant Temp	35°C
Oil Pressure	100kPa
Battery Voltage	24.5V
Inst. FC	1L/h
Accum. FC	25L
Subtotal FC	25L
Total Time	2:18:25
Subtotal Time	2.3
Hand throttle is active	
Target speed 800r/min	
At Rest	

Fig.3 GOV Interface

Initial target speed value is initial throttle speed value that user-defined.

- b) Target speed changes along with regulating throttle knob, then engine speed will be controlled by the controller on the basis of target speed value. The speed resolution (throttle knob each turn of a grid) is the setting throttle resolution, if adjusted target speed by throttle knob is over the max pre-set throttle speed, it will be forced to equal to the max speed value; if adjusted target speed by throttle knob is below the pre-set minimum throttle speed, it will be forced to equal to the minimum speed value;
- c) Press throttle knob, engine target speed value will be forced to equal to the minimum setting speed value;
- d) Press **on/off** again to exit hand throttle mode.

5.5 ENGINE DIAGNOSIS OPERATION

- a) Press **Diag** key to enter into **Diagnosis Mode** if controller with ECU alarms;
- b) After system enters into diagnosis mode, if the first ECU alarm is shutdown alarm, engine red light will flash once at first; if ECU alarm is warning alarm, engine yellow light will flash once at first;
- c) After alarm types were indicated, engine detailed fault information can be checked according to the red light flash frequency, for example, red light first time flashes twice, second time flashes 3 times, and third time flashes 5 times, then fault code (indicator) data is 235, and corresponding information is low coolant level alarm;
- d) If ECU fault occurs, fault information is the same failure, and then the light flashes twice;
- e) If there are other ECU alarms, please repeat step b-c;
- f) Again press **Diag** key to exit diagnosis mode;
- g) If ECU has no alarms, press **Diag** key, both engine red light and yellow light are light off.

SmartGen

6 PROTECTIONS

6.1 WARNING ALARMS

When controller detects warning alarms, it only sends warnings but not shuts down, and corresponding warning alarm types are displayed on LCD. If controller detects more than one ECU alarms (if more than 5 pieces), LCD will display max 5 ECU alarms.

Table 11 Warning Alarms

No	Type	Description
1	Battery Over Volt	When the controller detects that the battery voltage has exceeded the pre-set value, it will initiate a warning alarm
2	Battery Under Volt	When the controller detects that the battery voltage has fallen below the pre-set value, it will initiate a warning alarm
3	Oil Filter Maintenance Due	When the running time is arrived at preset oil filter maintenance time, it will initiate a warning alarm.
4	Diesel Filter Maintenance Due	When the running time is arrived at preset diesel filter maintenance time, it will initiate a warning alarm.
5	ECU Warning	When the controller received engine warning signals via J1939, it will initiate a warning alarm and fault code and name will be displayed.
6	Low Fuel Level	When the controller detects that the fuel level has fallen below the pre-set value, it will initiate a warning alarm.
7	Fuel Level Open Circuit	When the controller detects that the fuel level sensor open circuit, it will initiate a warning alarm.
8	Flexible Sensor 1-2 Open Circuit	After sensors are enabled, when the controller detects corresponding sensor is open circuit. It will initiate a warning alarm.
9	Flexible Sensor 1-2 High	After sensors are enabled, when the controller detects that the sensor value has exceeded the pre-set upper limit value, it will initiate a warning alarm.
10	Flexible Sensor 1-2 Low	After sensors are enabled, When the controller detects that the sensor value has fallen below the pre-set lower limit value, it will initiate a warning alarm.
11	Input Port 1-5 Warn	When digital input port is set as warning and it is active, it will initiate a warning alarm.
12	Air Filter Block	When air filter block input is active, it will initiate a warning alarm.
13	Low Water Level	When low water level input is active, it will initiate a warning alarm.
14	Crank Failure	If the number of controller start attempts exceeds pre-set start times, it will initiate a warning alarm.
15	High Temp Warn (ECU)	When controller detects ECU temperature is higher than set value, it will initiate a warning signal.
16	Low Oil Pressure Warn (ECU)	When controller detects ECU oil pressure is lower than set value, it will initiate a warning signal.

6.2 SHUTDOWN ALARMS

When controller detects shutdown alarms, detailed alarms information will be displayed on LCD alarm page.

NOTE: When shutdown is disabled, if controller detects shutdown alarms, it only displays shutdown alarm information but not control ECU shutdown, users need to press “Stop” key to shutdown ECU; when it is enabled, if controller detects shutdown alarms, it will control ECU shutdown.

Table 12 Shutdown Alarms

No	Type	Description
1	ECU Shutdown	When the controller received engine shutdown signals via J1939, it will initiate a shutdown alarm and fault code and name will be displayed.
2	ECU Comm. Failure	When the engine start up but controller didn't via J1939 receive engine warning signals, it will initiate a shutdown alarm.
3	Flexible Sensor 1-2 High	After sensors are enabled, When the controller detects that the sensor value has exceeded the pre-set upper limit value, it will initiate a shutdown alarm.
4	Flexible Sensor 1-2 Low	After sensors are enabled, When the controller detects that the sensor value has fallen below the pre-set lower limit value, it will initiate a shutdown alarm.
5	Input Port 1-5 Shut.	When digital input port is configured as “shutdown” and after it is active, it will initiate a shutdown alarm.
6	Alarm Shutdown Input	When the input port of “Alarm Shutdown Input” is active, it will initiate a shutdown alarm.
7	High Temp Shut. (ECU)	When controller detects ECU temperature is higher than set value, it will initiate a shutdown alarm.
8	Low OL Shut. (ECU)	When controller detects ECU oil pressure is lower than set value, it will initiate a shutdown alarm.

7 WIRING CONNECTION



Fig.4 Controller Back Panel

Table 13 Terminal Wiring Description

No.	Functions	Cable Size	Remark
A Plug Terminal (Back Panel)			
1	Ground Loop	1.0mm ²	ECU ground loop
2	NC	1.0mm ²	NC
3	Aux. Input 5	1.0mm ²	Digital input port
4	Aux. Input 4	1.0mm ²	Digital input port
5	GND	1.0mm ²	GND
6	Aux. Input 2	1.0mm ²	Digital input port
7	Aux. Input 3	1.0mm ²	Digital input port
8	Air Filter Block Alarm Input	1.0mm ²	Air filter block alarm input
9	Charging Indicator Input	1.0mm ²	Digital input port
10	Shutdown Indicator Input (red light)	1.0mm ²	Digital input port
11	Warning Indicator Input (yellow light)	1.0mm ²	Digital input port
12	Waiting for Start Indicator Input	1.0mm ²	Digital input port
13	Diagnosis Paging Up Input	1.0mm ²	Output port control, the max contact capacity is 7A
14	NC	1.0mm ²	NC
15	NC	1.0mm ²	NC
16	GND	1.0mm ²	GND
17	NC	1.0mm ²	NC
18	NC	1.0mm ²	NC
19	NC	1.0mm ²	NC
20	Aux. Input 1	1.0mm ²	Digital input port
21	Low Water Level Warning	1.0mm ²	Low water level warning input port
22	GND	1.0mm ²	GND
23	Flexible Sensor 2	1.0mm ²	Analog input port
24	Diagnosis Output	1.0mm ²	Output after diagnosis is active
25	Diagnosis Paging Down	1.0mm ²	Diagnosis paging down output
26	NC	1.0mm ²	NC
27	RS485 (B)	0.5mm ²	RS485 (B)
28	RS485 (A)	0.5mm ²	RS485 (A)
29	RS485 (SCR)	0.5mm ²	RS485 (SCR)
30	NC	1.0mm ²	NC
31	32/33 Relay Output COM	1.5mm ²	32/33 relay output common port
32	Aux. Output 1	1.5mm ²	Output port control, the max contact capacity is 7A
33	Aux. Output 2	1.5mm ²	Output port control, the max contact capacity is 7A

No.	Functions	Cable Size	Remark
34	Fuel Level Sensor Input	1.0mm ²	Analog input port
35	Flexible Sensor 1	1.0mm ²	Analog input port
B Plug Terminal (Back Panel)			
1	Crank Output	1.5mm ²	Connecting with crank output capacity 16A
2	CAN2(SCR)	0.5mm ²	Standby CANBUS
3	CAN2(L)	0.5mm ²	Standby CANBUS
4	CAN2(H)	0.5mm ²	Standby CANBUS
5	CAN1(SCR)	0.5mm ²	Engine J1939 CANBUS
6	Crank Output	1.5mm ²	Connecting with crank output capacity 16A
7	B+	1.5mm ²	Working power supply DC B+
8	B-	1.5mm ²	Working power supply DC B-
9	CAN1(L)	0.5mm ²	Engine J1939 CANBUS
10	ECU Power Supply	1.5mm ²	Connecting with ECU power output capacity 16A
11	ECU Power Supply	1.5mm ²	Connecting with ECU power output capacity 16A
12	B+	1.5mm ²	Working power supply DC B+
13	B-	1.5mm ²	Working power supply DC B-
14	CAN1(H)	0.5mm ²	Engine J1939 CANBUS

8 SCOPES AND DEFINITIONS OF PROGRAMMABLE PARAMETERS

8.1 CONTENTS AND SCOPES OF PARAMETERS

Table 14 Parameter Setting Contents and Scopes

No.	Items	Parameters	Defaults	Description
Timer Settings				
1	Pre-heat Delay	(0-3600)s	0	Time of pre-powering heat plug before starter is powered up.
2	Cranking Time	(3-60)s	8	Time of each starter power on.
3	Crank Rest Time	(3-60)s	10	The waiting time before second power up when engine crank failure.
4	Safety On Delay	(0-3600)s	10	Period of running time after engine crank success.
5	Start Idle Time	(0-3600)s	0	The time engine runs at idling speed when starts. The controller performs this stage only when the input port "Fire Input" is active.
6	Warming Up Time	(0-3600)s	0	After the engine enters high-speed running, the warning up time before normal running. The controller performs this stage only when the input port "Fire Input" is active.
7	Cooling Time	(0-3600)s	10	Cooling time for engine before stopping.
8	Stop Idle Time	(0-3600)s	0	The time engine runs at idling speed when stops. The controller performs this stage only when the input port "Fire Input" is active.
9	ETS Solenoid Hold	(0-3600)s	20	ECU power off time after pressing stop key.
10	Fail to Stop Time	(0-3600)s	0	Time from engine ETS solenoid hold time expired to stop completely.
11	Power Off Delay	(15-150)s	35	The delay time for power off after pressing power key.
Engine Settings				
1	Engine Type	(0-39)	1	Default: J1939 Engine When connected to J1939 engine, choose the corresponding type.
2	SPN Alarm Version	(1-3)	1	Selection for SPN alarm version.
3	Battery Rated Volt	(0-60.0)V	24.0	Provide judgment standard for battery over voltage/under voltage.
4	Crank Attempts	(1-30)times	1	Max. crank attempts. When reach this

No.	Items	Parameters	Defaults	Description
				number, controller will send crank failure signal.
5	Disconnect Speed	(1-1000)r/min	350	When engine speed is higher than the set value, starter will be disconnected.
6	Battery Over Volt Warn	(0-200)%	125	When battery volt is higher than preset volt percentage, controller will send battery voltage high warning alarm.
7	Battery Under Volt Warn	(0-200)%	80	When battery volt is lower than preset volt percentage, controller will send battery voltage low warning alarm.
8	Throttle Start Speed	(0-2000)r/min	800	The minimum engine speed of throttle can be adjusted.
9	Throttle Max. Speed	(0-3000)r/min	2500	The max engine speed of throttle can be adjusted.
10	Throttle Resolution	(0-100)r/min	50	Resolution of the throttle knob each turn of a grid.
11	SPN Alarm Mask Code 1	(0-65535)	0	It can shield corresponding SPN alarm.
12	SPN Alarm Mask Code 2	(0-65535)	0	It can shield corresponding SPN alarm.
13	SPN Alarm Mask Code 3	(0-65535)	0	It can shield corresponding SPN alarm.
14	ECU Comm. Fail Act	(0-1)	0	0: Warning; 1: Shutdown
15	Shutdown Inhibit	(0-1)	1	0: Disable; 1: Enable
16	ECU Comm. Address	(0-255)	7	It is used for setting ECU communication address.
17	Throttle Idle Speed	(0-1)	1	0: Disable; 1; Enable
Module Settings				
1	Module Address	(1-254)	1	It is used for setting RS485 communication address.
2	Language	(0-2)	0	0: Simplified Chinese 1: English 2: Traditional Chinese
3	Password	(0-9999)	00318	For entering advanced parameters setting.
4	Oil Filter 1 st Maintenance	(1-5000)h	200	First maintenance time of oil filter setting.
5	Oil Filter Maintenance Time	(1-5000)h	250	Oil filters normal maintenance interval setting.
6	Diesel Filter 1 st Maintenance	(1-5000)h	200	First maintenance time of diesel filters setting.
7	Diesel Filter Maintenance Time	(1-5000)h	250	Diesel filters normal maintenance interval setting.

No.	Items	Parameters	Defaults	Description
8	Boot Password Setting	(0-999)	0	Press start key and enter start password to get into controller main screen.
9	Boot Password Enable	(0-1)	0	0: Disable; 1: Enable
10	Date & Time			Users can manually calibrate date and time.
11	Boot Screen	(0-1)	0	0: Disable; 1: Enable
12	Mode Selection	(0-1)	0	0: Local Mode; 1: Remote Mode
Fuel Level Sensor				
1	Curve Type	(0-15)	3	SGD
2	Low Level Warning	(0-100)%	10	When the value of external level sensor bellows the default value, controller will initiate corresponding alarm. (It is always detected)
3	Warning Delay	(0-3600)s	2	When the value of level sensor is below preset warning value, controller will initiate corresponding alarm after delay.
Flexible Sensor 1-2				
1	Sensor Type	(0-3)	0	0: Not used 1: Pressure 2: Temperature 3: Level
2	Curve Type	(0-15)	0	Changed according to sensor type. Sensor types details please to see Table 19.
3	Alarm Speed Set	(0-3000)r/min	1200	When controller detects engine speed exceeds preset alarm speed, system starts detecting and initiating alarms.
4	Upper Limit Shut Enabled	(0-1)	1	Sensor upper limit shutdown enabled setting.
5	Upper Limit Shut Value	(0-6000)	98	Sensor upper limit shutdown value setting.
6	Stop Delay	(0-3600)s	5	Sensor upper limit stop delay setting.
7	Lower Limit Shut Enabled	(0-1)	0	Sensor lower limit shutdown enabled setting.
8	Lower Limit Shut Value	(0-400)	0	Sensor lower limit shutdown value setting.
9	Stop Delay	(0-3600)s	5	Sensor lower limit stop delay setting.
10	Upper Limit Warning Enabled	(0-1)	1	Sensor upper limit warning enabled setting.
11	Upper Limit Warning Value	(0-6000)	92	Sensor upper limit warning value setting.
12	Warning Delay	(0-3600)s	2	Sensor upper limit warning delay setting.
13	Lower Limit	(0-1)	0	Sensor lower limit warning enabled setting.

No.	Items	Parameters	Defaults	Description
	Warning Enabled			
14	Lower Limit Warning Value	(0-4000)	0	Sensor lower limit warning value setting.
15	Warning Delay	(0-3600)s	2	Sensor lower limit warning delay setting.
High Temp. Protection Setting (ECU)				
1	Alarm Speed Set	(0-3000)r/min	1200	When controller measures the engine speed is higher than set value, system will detect alarm.
2	Upper Limit Shut. Enable	(0-1)	0	Shutdown enable setting of ECU high temperature upper limit.
3	Upper Limit Shut. Value	(0-300)	98	Shutdown value setting of ECU high temperature upper limit.
4	Stop Delay Time	(0-3600)s	5	Stop delay setting of ECU high temperature.
5	Upper Limit Warn Enable	(0-1)	0	Warn enable setting of ECU high temperature upper limit.
6	Upper Limit Warn Value	(0-300)	92	Warn value setting of ECU high temperature upper limit.
7	Upper Limit Warn Return Delay	(0-300)	85	Warn return value setting of ECU high temperature upper limit.
8	Warn Delay	(0-3600)s	2	Warn Delay value setting of ECU high temperature upper limit.
Low Oil Pressure Protection Setting (ECU)				
1	Alarm Speed Set	(0-3000)r/min	1200	When controller measures the engine speed is higher than set value, system will detect alarm.
2	Lower Limit Shut. Enable	(0-1)	0	Shutdown enable setting of ECU low oil pressure lower limit.
3	Lower Limit Shut. Value	(0-1000)	103	Shutdown value setting of ECU low oil pressure lower limit.
4	Stop Delay Time	(0-3600)s	5	Stop delay setting of ECU low oil pressure.
5	Lower Limit Warn Enable	(0-1)	0	Warn enable setting of ECU low oil pressure lower limit.
6	Lower Limit Warn Value	(0-1000)	124	Warn value setting of ECU low oil pressure lower limit.
7	Lower Limit Warn Return Delay	(0-1000)	138	Warn return value setting of ECU low oil pressure lower limit.
8	Warn Delay	(0-3600)s	2	Warn Delay value setting of ECU low oil pressure lower limit.
Digital Input Ports				
Digital Input Port 1				
1	Content Setting	(0-50)	0	Not used.

No.	Items	Parameters	Defaults	Description
2	Active Type	(0-1)	0	0: Close 1: Open
Digital Input Port 2				
1	Content Setting	(0-50)	0	Not used.
2	Active Type	(0-1)	0	0: Close 1: Open
Digital Input Port 3				
1	Content Setting	(0-50)	0	Not used.
2	Active Type	(0-1)	0	0: Close 1: Open
Digital Input Port 4				
1	Content Setting	(0-50)	0	Not used.
2	Active Type	(0-1)	0	0: Close 1: Open
Digital Input Port 5				
1	Content Setting	(0-50)	0	Not used.
2	Active Type	(0-1)	0	0: Close 1: Open
Auxiliary Outputs				
Aux. Output Port 1				
1	Content Setting	(0-50)	0	Not used.
2	Active Type	(0-1)	0	0: Normally Open; 1: Normally Close.
Aux. Output Port 2				
1	Content Setting	(0-50)	0	Not used.
2	Active Type	(0-1)	0	0: Normally Open; 1: Normally Close.

8.2 DEFINABLE CONTENTS OF AUXILIARY OUTPUT PORT 1-2

Table 15 Definable Contents of Auxiliary Output Port 1-2

No.	Type	Description
0	Not Used	
1	User Configured	See Table 16 <i>Users-defined Functions of Auxiliary Output Ports</i>
2	Audible Alarm	Output when alarms occur.
3	ECU Power Supply	Output after controller is powered up, and disconnect when ETS.
4	Preheat Output	When fuel outputs, preheat output is active.
5	Crank Relay Output	Output when controller starts up.
6	Reserved	Reserved
7	ETS Output	Output when controller stops.
8	Reserved	Reserved
9	Reserved	Reserved
10	Common Alarm	Output when controller has warning/shutdown alarms.
11	Common Shutdown Alarm	Output when controller has shutdown alarms.
12	Common Warning Alarm	Output when controller has warning alarms.
13	Input 1 Active	Output when digital input port 1 is active.
14	Input 2 Active	Output when digital input port 2 is active.
15	Input 3 Active	Output when digital input port 3 is active.
16	Input 4 Active	Output when digital input port 4 is active.
17	Input 5 Active	Output when digital input port 5 is active.
18	Reserved	Reserved
19	Reserved	Reserved
20	Reserved	Reserved
21	Crank Success Output	Output after engine crank successfully.
22	Normal Running Output	Output after engine running normally.
23	ECU Comm. Failure Shut	Output when ECU fails to communicate shutdown occurs.
24	Battery Under Volt Warning	Output when battery under voltage warning occurs.
25	Battery Over Volt Warning	Output when battery over voltage warning occurs.
26	Reserved	Reserved
27	Reserved	Reserved
28	Reserved	Reserved
29	Crank Failure Alarm	Output when controller fails to start alarm occurs.
30	Reserved	Reserved
31	Reserved	Reserved
32	Sensor 1 Open Warning	Output when flexible sensor 1 is open circuit.
33	Sensor 1 Warning	Output when flexible sensor 1 is high/low warning occurs.
34	Sensor 1 Shutdown	Output when flexible sensor 1 is high/low shutdown occurs.
35	Sensor 2 Open Warning	Output when flexible sensor 2 is open circuit.
36	Sensor 2 Warning	Output when flexible sensor 2 is high/low warning occurs.

No.	Type	Description
37	Sensor 2 Shutdown	Output when flexible sensor 2 is high/low shutdown occurs.
38	Fuel Level Open Warning	Output when fuel level sensor is open circuit.
39	Fuel Level Warning	Output when low fuel level warning occurs.
40	Reserved	Reserved
41-50	Reserved	Reserved

Table 16 Users-defined Functions of Auxiliary Output Ports

No.	Item	Content	Remark
1	Function Selection	(0-50)	
2	Output Type	0 Close 1 Open	
3	Active Speed	(0-2000)r/min	
4	Delay Output Time	(0-100.0)s	
5	Output Time	(0-3600)s	

NOTE: Active Speed, delay output time, output time settings can only be set via PC software.

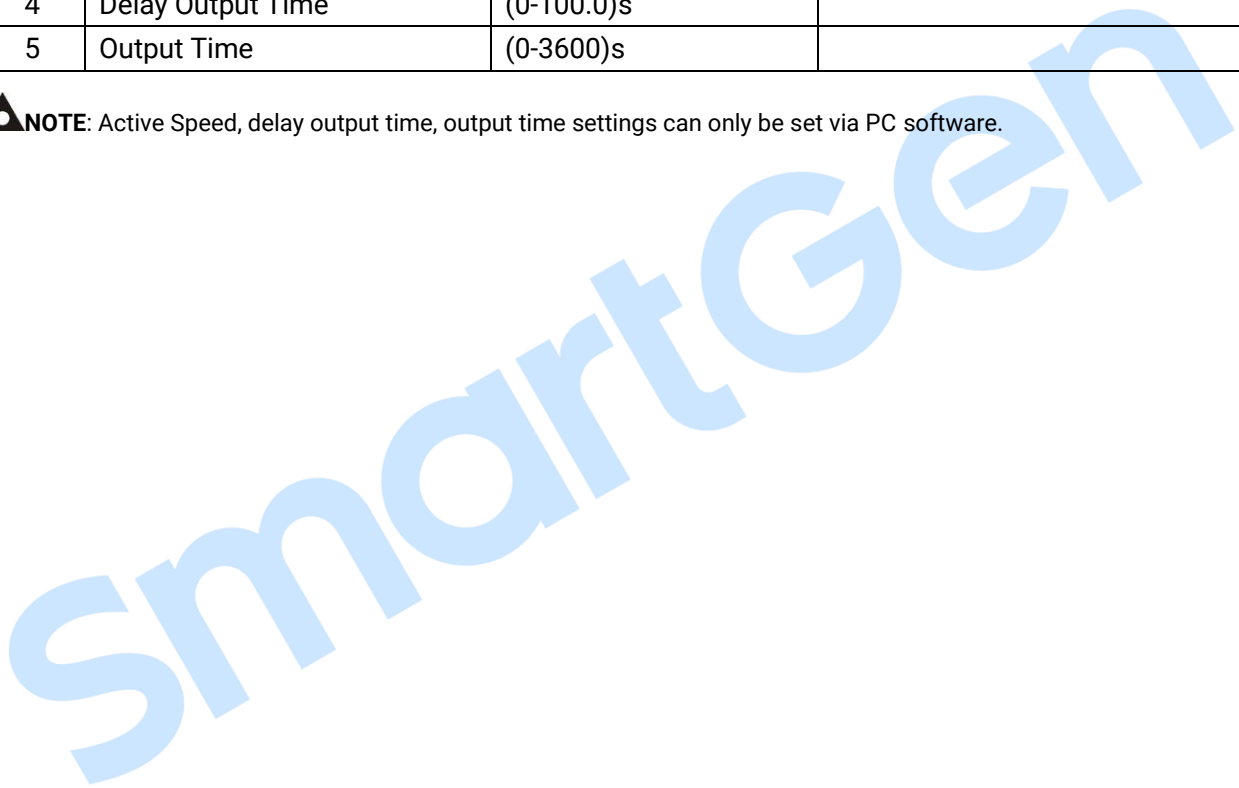

8.3 DEFINABLE CONTENTS OF DIGITAL INPUT PORTS

Table 17 Definable Contents of Digital Input Ports

No.	Type	Description
0	Not Used	
1	User Configured	Details to <i>Table 18 User-defined Functions of Digital Input Ports.</i>
2	Alarm Mute	Through this key to mute alarms if audible alarms occurred.
3	Alarm Reset	Trough this key to reset alarms if shutdown alarms occurred.
4	Reserved	Reserved
5	Reserved	Reserved
6	Idle Mode	When input is active, it returns to the initiating speed (idle speed value).
7	Manual Throttle Control	When input is active, speed can be adjusted manually.
8	Speed Raise Input	When input is active, for speed raise once (step length is throttle resolution), self-reset button can be connected.
9	Speed Drop Input	When input is active, for speed drop once (step length is throttle resolution), self-reset button can be connected.
10	Reserved	Reserved
11	Reserved	Reserved
12	Simulate Stop Key	An external button (not self-locking) can be connected to simulate the panel button being pressed.
13	Simulate Start Key	
14	Reserved	Reserved
15	Reserved	Reserved
16	Reserved	Reserved
17	Alarm Shutdown Input	When input is active, the engine will alarm shutdown.
18	Reserved	Reserved
19	Remote Start	When the input is active, the engine can start automatically without speed regulation. When the input is inactive, the engine can stop automatically.
20	Fire Input	When the input is active, the engine can start automatically and raise to the max. speed according to the running stage. When the input is inactive, the engine can stop automatically.
21	Remote Mode	When the input is active, remote control module can control the local start/stop of the engine; when the input is inactive, remote control module cannot control the local module.
22	Reserved	Reserved
23	Reserved	Reserved
24	Reserved	Reserved
25	Reserved	Reserved
26	Reserved	Reserved
27	Reserved	Reserved
28	Reserved	Reserved

No.	Type	Description
29	Reserved	Reserved
30	Local/Remote (CAN2 Communication)	When it is active, start, stop, speed adjusting can be controlled via CAN2; when it is inactive, only local control is available.
31-50	Reserved	Reserved

Table 18 User-defined Functions of Digital Input Ports

No.	Item	Content	Remark
1	Setting	(0-50)	Details to see Table 17 <i>Definable Contents of Digital Input Ports</i>
2	Active Type	(0-1)	0: Close to activate 1: Open to activate
3	Active Speed	(0-2500)r/min	Alarm is active when speed exceeded this value.
4	Active Action	(0-2)	0: Warning 1: Shutdown 2: No Action
5	Input Delay	(0-20.0)s	

NOTE: User-defined input ports character strings can be set only via PC software.

8.4 SENSORS SELECTION

Table 19 Sensors Selection

No.	Type	Content	Remark
1	Pressure Sensor	0 Not Used 1 Reserved 2 Custom Resistance Curve 3 VDO 10Bar 4 CURTIS 5 VOLVO-EC 6 DATCON 10Bar 7 SGX 8 SGD 9 SGH 10-15 Reserved	Defined resistance's range is 0~1kΩ, default is reserved.
2	Temp Sensor	0 Not Used 1 Reserved 2 Custom Resistance Curve 3 VDO 4 CURTIS 5 VOLVO-EC 6 DATCON 7 SGX 8 SGD 9 SGH 10 PT100 11-15 Reserved	Defined resistance's range is 0~1kΩ, default is reserved.
3	Fuel Level Sensor	0 Not Used 1 Custom Resistance Curve 2 Reserved 3 SGD 4 SGH 5-15 Reserved	Defined resistance's range is 0~1kΩ, default is SGD sensor.

9 SENSORS SETTING

- a) When reselect sensors, the sensor curve will be transferred into the standard value. For example, if temperature sensor is SGH (120°C resistor type), its sensor curve is SGH (120°C resistor type); if select the SGD (120°C resistor type), the temperature sensor curve is SGD curve.
- b) When there is difference between standard sensor curves and using sensor, user can adjust it in “curve type” and input target curvilinear coordinate.
- c) When input the sensor curve, X value (resistor) must be input from small to large, otherwise, mistake occurs.
- d) The headmost or backmost values in the vertical coordinates can be set as same as below,

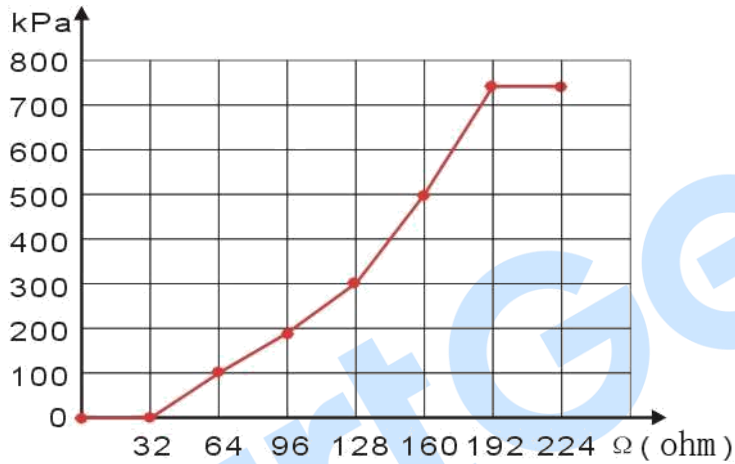

Fig.5 Oil Pressure Sensor Curve

Table 20 Normal Pressure Unit Conversion Form

Item	N/m ² (pa)	kgf/cm ²	bar	psi
1Pa	1	1.02x10 ⁻⁵	1x10 ⁻⁵	1.45x10 ⁻⁴
1kgf/cm ²	9.8x10 ⁴	1	0.98	14.2
1bar	1x10 ⁵	1.02	1	14.5
1psi	6.89x10 ³	7.03x10 ⁻²	6.89x10 ⁻²	1

10 TYPICAL APPLICATION

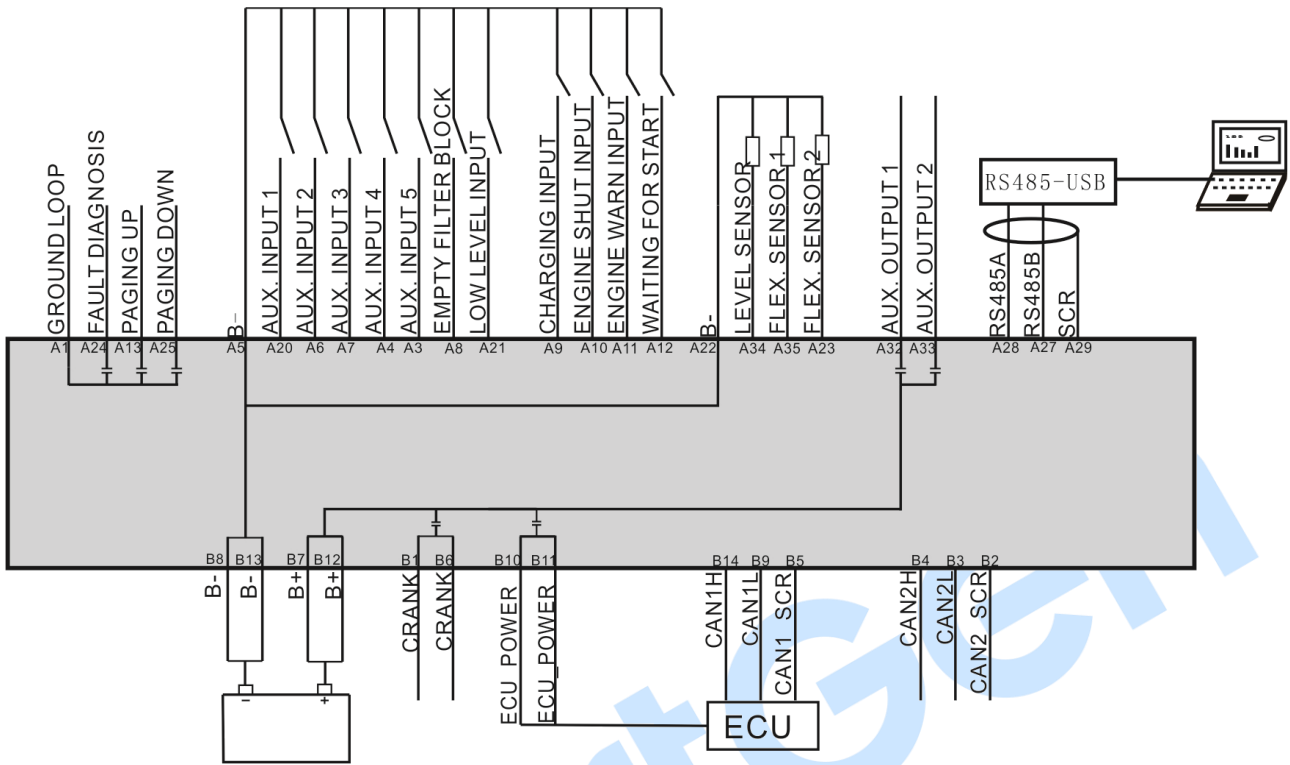

Fig.6 HEM8400 Typical Application Diagram

11 INSTALLATION

11.1 FIXING CLIPS

- 1) The module is held into the panel fascia using the supplied fixing bolts.
- 2) Use 4 pieces $\Phi 4$ screws and nuts fixed on the 4 corresponding screw holes.
- 3) Care should be taken not to over tighten the screws of fixing clips.

11.2 OVERALL DIMENSION AND PANEL CUTOUT

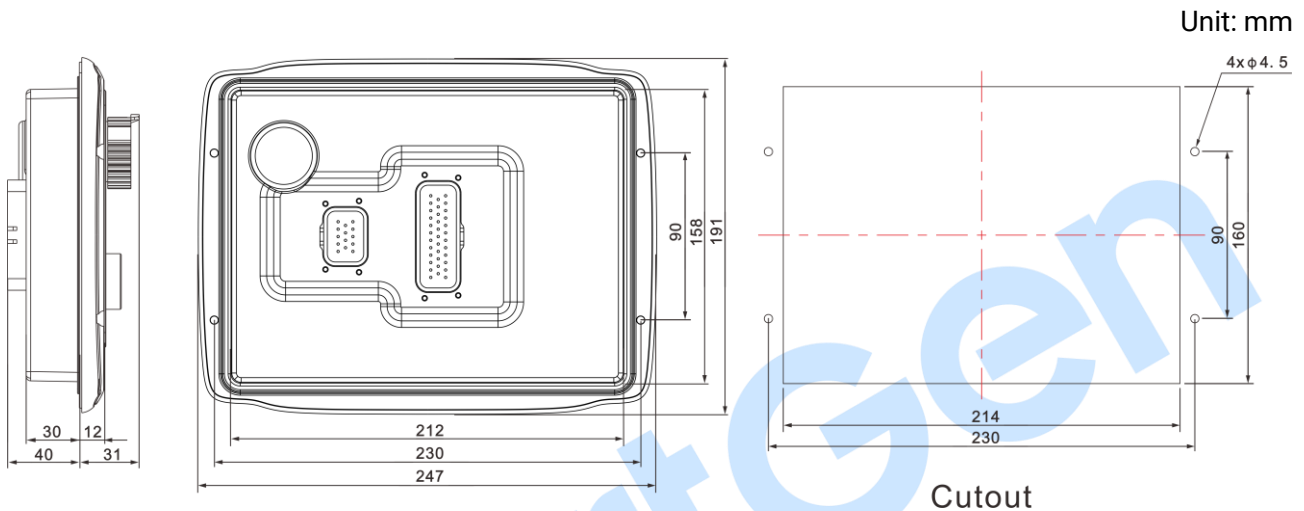

Fig. 7 Overall Dimension and Panel Cutout

HEM8400 controller can suit for widely range of battery voltage DC (10~35)V. Negative of battery must be connected with the shell of starter stable. The wire's diameter must be over 2.5mm^2 and which is connected to B+ and B- of controller power. If floating charger configured, please firstly connect output wires of charger to battery's positive and negative directly, then, connect wires from battery's positive and negative to controller's positive and negative input ports in order to prevent charger disturbing the controller's normal working.

a) **Output and Expand Relays**

All outputs of controller are relay contact output type. If need to expand the relays, please add freewheel diode to both ends of expand relay's coils (when coils of relay have DC current) or, increase resistance-capacitance loop (when coils of relay have AC current), in order to prevent disturbance to controller or others equipment.

b) **Withstand Voltage Test**

When controller had been installed in control panel, if need the high voltage test, please disconnect controller's all terminal connections, in order to prevent high voltage into controller and damage it.

12 CONNECTIONS OF CONTROLLER AND J1939 ENGINE

12.1 CUMMINS QSL9

It is suitable for CM850 engine control module.

Table 21 50-Pin Connector

Terminals of controller	50 pins connector	Remark
ECU Power	39	
Starting relay output	-	Connected to starter coil directly.

Table 22 9-Pin Connector

Terminals of controller	9 pins connector	Remark
CAN_SCR	SAE J1939 shield-E	CAN communication shielding line (connected with ECU terminal only).
CAN(H)	SAE J1939 signal-C	Using impedance 120Ω connecting line.
CAN(L)	SAE J1939 return-D	Using impedance 120Ω connecting line.

Engine type: Cummins-CM850.

12.2 CUMMINS QSX15-CM570

It is suitable for CM570 engine control module. Engine type is QSX15 etc.

Table 23 50-Pin Connector

Terminals of controller	50 pins connector	Remark
ECU Power	38	Injection switch.
Starting relay output	-	Connected to starter coil directly.

Table 24 9-Pin Connector

Terminals of controller	9 pins connector	Remark
CAN_SCR	SAE J1939 shield-E	CAN communication shielding line (connected with ECU terminal only).
CAN(H)	SAE J1939 signal-C	Using impedance 120Ω connecting line.
CAN(L)	SAE J1939 return-D	Using impedance 120Ω connecting line.

Engine type: Cummins QSX15-CM570.

12.3 CUMMINS QSM11

Table 25 Engine OEM Connector

Terminals of controller	OEM connector of engine	Remark
ECU Power	38	
Starting relay output	-	Connected with starter coil directly.
CAN_SCR	-	CAN communication shielding line.
CAN(H)	46	Using impedance 120Ω connecting line.
CAN(L)	37	Using impedance 120Ω connecting line.

Engine type: Common J1939.

12.4 DETROIT DIESEL DDEC III/IV

Table 26 Engine CAN Port

Terminals of controller	CAN port of engine	Remark
ECU Power	Expansion 30A relay, providing battery voltage for ECU.	
Starting relay output	-	Connected to starter coil directly.
CAN_SCR	-	CAN communication shielding line.
CAN(H)	CAN(H)	Using impedance 120Ω connecting line.
CAN(L)	CAN(L)	Using impedance 120Ω connecting line.

Engine type: Common J1939.

12.5 MTU ADEC (SMART MODULE)

It is suitable for MTU engine with ADEC (ECU8) and SMART module.

Table 27 ADEC (X1 Port)

Terminals of controller	ADEC (X1 port)	Remark
ECU Power	X1 10	X1 9 shall connect negative of battery.
Starting relay output	X1 34	X1 33 shall connect negative of battery.

Table 28 SMART (X4 Port)

Terminals of controller	SMART (X23 port)	Remark
CAN_SCR	X4 3	CAN communication shielding line.
CAN(H)	X4 1	Using impedance 120Ω connecting line.
CAN(L)	X4 2	Using impedance 120Ω connecting line.

Engine type: mtu-ADEC.

12.6 MTU ADEC (SAM MODULE)

Suitable for MTU engine with ADEC (ECU7) and SAM module.

Table 29 ADEC (X1 Port)

Terminals of controller	ADEC (X1 port)	Remark
ECU Power	X1 43	X1 28 shall connect negative of battery.
Starting relay output	X1 37	X1 22 shall connect negative of battery.

Table 30 SAM (X23 Port)

Terminals of controller	SAM (X23 Port)	Remark
CAN_SCR	X23 3	CAN communication shielding line.
CAN(H)	X23 2	Using impedance 120Ω connecting line.
CAN(L)	X23 1	Using impedance 120Ω connecting line.

Engine type: Common J1939.

12.7 SCANIA

It is suitable for S6 engine control module. Engine type is DC9, DC12, and DC16.

Table 31 B1 Connector

Terminals of controller	B1 connector	Remark
ECU Power	3	
Starting relay output	-	Connected to starter coil directly.
CAN_SCR	-	CAN communication shielding line.
CAN(H)	9	Using impedance 120Ω connecting line.
CAN(L)	10	Using impedance 120Ω connecting line.

Engine type: Scania.

12.8 WEICHAI

12.8.1 BOSCH COMMON RAIL ELECTRIC-CONTROLLED ENGINE

It is suitable for Weichai BOSCH common rail electric-controlled engine.

Table 32 Engine Port

Terminals of controller	Engine port	Remark
ECU Power	1.40	Connected to engine ignition lock.
Starting relay output	1.61	
CAN_SCR	-	CAN communication shielding line.
CAN(H)	1.35	Using impedance 120Ω connecting line.
CAN(L)	1.34	Using impedance 120Ω connecting line.

Engine type: GTSC1.

12.8.2 WISE15 ELECTRIC-CONTROLLED ENGINE

It is suitable for Weichai WISE15 electric-controlled engine.

Table 33 Engine Port

Terminals of controller	Engine port	Remark
ECU Power	1.59	Connected to engine ignition lock.
Starting relay output	1.58	
CAN_SCR	-	CAN communication shielding line.
CAN(H)	1.42	Using impedance 120Ω connecting line.
CAN(L)	1.43	Using impedance 120Ω connecting line.

Engine type: GTSC1.

▲NOTE: If there is any problem in the communication between the controller and ECU, please contact our service personnel.



13 FAULT FINDING

Table 34 Fault Finding

Symptoms	Possible Solutions
Controller no response with power	Check starting batteries; Check controller connection wirings; Check DC fuse.
Shutdown alarm in running	Check related switch and its connections according to the information on LCD; Check programmable inputs.
Fail to start	Check fuel oil circuit and its connections; Check starting batteries; Check speed sensor and its connections; Refer to engine manual.
Starter no response	Check starter connections; Check starting batteries.