

# SmartGen

MAKING CONTROL SMARTER

## HGM8140

### GENSET CONTROLLER

### USER MANUAL



HGM8140D DISPLAY MODULE

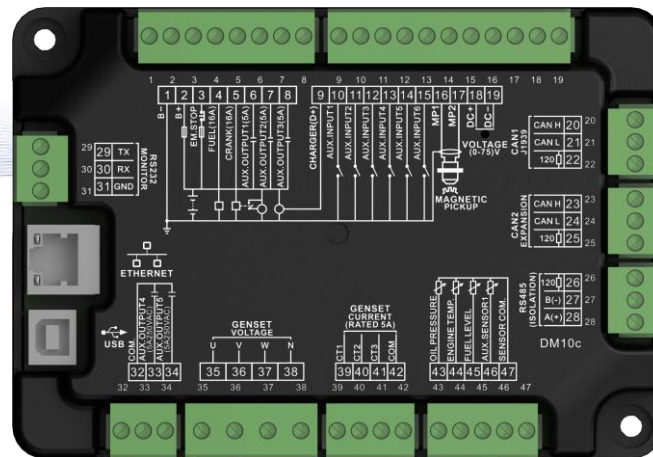

HGM8140M MAIN MODULE

郑州众智科技股份有限公司  
SMARTGEN(ZHENGZHOU)TECHNOLOGY CO.,LTD.

All rights reserved. No part of this publication may be reproduced in any material form (including photocopying or storing in any medium by electronic means or other) without the written permission of the copyright holder.

SmartGen reserves the right to change the contents of this document without prior notice.

**Table 1 Software Version**

Date	Version	Note
2018-11-27	1.0	Original Release;
2019-03-21	1.1	1. Table 8 32-34 & 43-47 Function Change; 2. Fig.8 Connection Diagram Change; 3. Fig.12 Overall and Installation Dimensions Change;
2019-09-12	1.2	1. Fix No.20-25, 27-28 function description in Table 8; 2. Fix Aux. Input 6 parameters in Table 10; 3. Delete an item in Table 5 and Table 6; 4. Add No.27-31 items in Table 12;
2023-04-12	1.3	1. Add installation panel thickness description; 2. Update company logo and address information; 3. Add No.30 "Fuel Pump Fault Alarm" in Table 4; 4. Add No.5-8 in Table 5; 5. Add parameter item 94-105 in Table 10; 6. Change No.25-27 to "Gen Overvoltage Warning", "Gen Undervoltage Warning", "Dummy Load Control" in Table 11; 7. Change No.16 to "Reserved", add No.32-35 in Table 12.
2023-12-28	1.4	Modify the current value of output ports 4&5 in Table 8 of terminal definition descriptions.

## CONTENT

1 OVERVIEW .....	5
2 PERFORMANCE AND CHARACTERISTICS .....	6
3 SPECIFICATION OPERATION .....	8
4 OPERATION .....	9
4.1 KEY FUNCTION.....	9
4.2 CONTROLLER PANEL.....	10
4.3 LCD DISPLAY.....	10
4.4 AUTO START/STOP OPERATION.....	11
4.5 MANUAL START/STOP OPERATION .....	12
4.6 EMERGENCY START UP .....	12
5 PROTECTION .....	13
5.1 WARNINGS .....	13
5.2 TRIP ALARM .....	15
5.3 TRIP AND STOP ALARMS.....	16
5.4 SHUTDOWN ALARMS .....	16
6 WIRINGS CONNECTION.....	19
6.1 HGM8140M GENSET CONTROLLER PANEL.....	19
6.2 HGM8140D GENSET CONTROLLER BACK PANEL .....	22
7 SCOPS AND DEFINITIONS OF PROGRAMMABLE PARAMETERS.....	23
7.1 CONTENTS AND SCOPES OF PARAMETERS.....	23
7.2 USER-DEFINED PERIOD OUTPUT .....	33
7.3 USER-DEFINED COMBINATION OUTPUT .....	34
8 PARAMETERS SETTING .....	39
9 SENSOR SETTING .....	40
10 COMMISSIONING.....	41
11 TYPICAL APPLICATION.....	42
12 INSTALLATION.....	44
12.1 FIXING CLIPS.....	44
12.2 OVERALL DIMENSION .....	44
13 CONNECTIONS OF CONTROLLER WITH J1939 ENGINE .....	46
13.1 CUMMINS ISB/ISBE .....	46
13.2 CUMMINS QSL9 .....	46
13.3 CUMMINS QSM11 (IMPORT) .....	47
13.4 CUMMINS QSX15-CM570 .....	47
13.5 CUMMINS GCS-MOVBUS .....	48
13.6 CUMMINS QSM11 .....	48
13.7 CUMMINS QSZ13.....	49
13.8 DETROIT DIESEL DDEC III/IV .....	49
13.9 DEUTZ EMR2 .....	50
13.10 JOHN DEERE .....	50
13.11 MTU MDEC .....	50

---

13.12 MTU ADEC (SMART MODULE).....	51
13.13 MTU ADEC (SAM MODULE) .....	51
13.14 PERKINS .....	52
13.15 SCANIA .....	52
13.16 VOLVO EDC3 .....	52
13.17 VOLVO EDC4 .....	53
13.18 VOLVO-EMS2.....	53
13.19 YUCHAI .....	54
13.20 WEICHAI .....	54
14 ETHERNET PORT .....	55
14.1 NETWORK CLIENT MODE.....	55
14.2 CONTROLLER AND NETWORK CABLE CONNECTION.....	55
15 TROUBLESHOOTING.....	56

SmartGen

## 1 OVERVIEW

**HGM8140** genset controller, integrated digital, intelligent, and networking technology, adopts “Main and Display “separated type mode. It is suitable for single unit automation and monitoring system to achieve automatic start/stop, data measurement, alarm protection as well as remote control, remote measurement and remote communication functions. HGM8140 controller, can be worked in (-40°C~+70°C), has LCD display, selectable Chinese, English and other languages interface, and it is reliable and easy to use. It is with SAE J1939 interface that can communicate with a number of ECU (ENGINE CONTROL UNIT) equipped with J1939.

**HGM8140** controller adopt micro-processor technology with precision parameters measuring, fixed value adjustment, time setting and set value adjusting and etc. Majority parameters can be configured from front panel, and all parameters can be configured by USB interface (or RS485, ETHERNET) to adjust via PC. It can be widely used in all types of automatic gen-set control system with compact structure, advanced circuits, simple connections and high reliability.

SmartGen

## 2 PERFORMANCE AND CHARACTERISTICS

**HGM8140 genset controller:** used for single set automation, it controls generator to auto start/stop by detecting DC input voltages or remote start signals.

**HGM8140 controller contains two modules:** HGM8140M (main module) and HGM8140D (display module). Two modules can connect by RS232 or CAN BUS communication.

**HGM8140M (main module):** it is used for collecting genset parameters, monitoring and protecting genset, and realizing genset auto start/stop function.

**HGM8140D (display module):** it is used for displaying genset's parameters, adjusting parameters and controlling genset by the keys on the front panel of controller.

Main features are as follows:

- 132x64 LCD with backlight, selectable language interface (Chinese, English and Spanish), push-button operation.
- Hard-screen acrylic material been used to protect screen with great wear-resisting and scratch-resisting functions.
- Silicone panel and pushbuttons can be used in extreme temperature environment.
- RS485 communication interface enable "Three remote functions" (remote control, remote measuring and remote communication) according to MODBUS protocol.
- ETHERNET communication port can achieve multi-monitoring modes.
- Equipped with CAN BUS port and can communicate with J1939 genset. Not only can monitor frequently-used data (such as water temperature, oil pressure, speed, fuel consumption and so on) of ECU machine, but also control starting up, shutdown, raising speed and dropping speed via CAN BUS port (need controller with CANBUS interface).
- HGM8140M can connect with HGM8140D module via RS232 or CANBUS port, which is convenient to use in special occasions. HGM8140D can be set as RS232 port display module or CAN port display module via front panel keys operation. HGM8140D module also be set as enabled/disabled control, if it is able to control, HGM8140M can be controlled by it, otherwise, remote control function is disabled.
- Suitable for 3-phase 4-wire, 3-phase 3-wire, single phase 2-wire, and 2-phase 3-wire systems with voltage 120/240V and frequency 50Hz/60Hz;
- Collects and shows 3-phase voltage, current, power parameter and frequency of generator or mains.

### **Mains**

Line voltage (Uab, Ubc, and Uca)

Phase voltage (Ua, Ub, and Uc)

Frequency Hz

Phase sequence

### **Load**

Current IA, IB, IC

Each phase and total active power kW

Reactive power kvar

Power factor PF

Load output percentage %

Apparent power kVA

Accumulate total generator power kWh

- For generator, controller has over and under voltage, over and under frequency, over current and over power detection functions.
- Precision measure and display parameters about Engine.

Temp. (WT)	°C/°F	
Oil Pressure (OP)	kPa/psi/bar	
Fuel Level (FL)	%	Fuel Quantity Left L
Speed (RPM)	r/min	
Voltage of Battery	V	
Voltage of Charger	V	
Hour count accumulation		
Start times accumulation		
- Protection: automatic start/stop of the gen-set, ATS (Auto Transfer Switch) control with perfect fault indication and protection function.
- With ETS (energize to stop), idle control, pre-heat control and rise/drop speed control functions, which are all relay outputs.
- Parameter setting: parameters can be modified and stored in internal FLASH memory and cannot be lost even in case of power outage; most of them can be adjusted using front panel of the controller and also can be modified using PC via USB or RS485 port.
- Multiple temperature, pressure, oil pressure sensor can be used and self-defined directly.
- Multiple crank disconnect conditions (speed sensor, oil pressure, generator frequency) are optional.
- All display interfaces can be adjusted.
- With emergency start function, which can be achieved by input port (Emergency Start) or press manual button and start button simultaneously on the panel. This function is used in the status of very low temperature in the winter and start genset manually in a very long time.
- With battle mode, all shutdown alarms except for emergency shutdown and over speed alarms are inhibited.
- With flywheel tooth number automatic recognition function.
- Widely power supply range DC(8~35)V, suitable to different starting battery voltage environment.
- All parameters used digital adjustment, instead of conventional analog modulation with normal potentiometer, more reliability and stability.
- With maintenance function. Types (date and running time) can be optional and actions (warning or shutdown) can be set when maintenance time out.
- Event log function. Maximum 99 event logs can be memorized.
- Data analysis function. 5 circular logs and genset detailed data in one minute before shutdown alarms.
- Real-time clock, scheduled start & stop generator (can be set as start genset once a day/week/month whether with load or not)
- Waterproof security level IP65 due to rubber seal installed between the controller enclosure and panel fascia;
- Modular design, anti-flaming ABS plastic enclosure, pluggable connection terminals and embedded installation way; compact structure with easy mounting.

3 SPECIFICATION OPERATION

Table 2 Technical Parameters









Items	Content
Working Voltage	DC8.0V to 35.0V, uninterruptible power supply
Overall Consumption	<3W (Standby mode: ≤2W)
AC Input:	
3 Phase 4 Wire	15V AC - 360V AC (ph-N)
3 Phase 3 Wire	30V AC - 620V AC (ph-ph)
Single Phase 2 Wire	15V AC - 360V AC (ph-N)
2 Phase 3 Wire	15V AC - 360V AC (ph-N)
Alternator Frequency	50Hz/60Hz
Speed Sensor Voltage	1.0 V to 24 V (RMS)
Speed Sensor Frequency	Maximum 10,000 Hz
Start Relay Output	16A DC28V power supply output
Fuel Relay Output	16A DC28V power supply output
Flexible Relay Output 1	5A DC28V power supply output
Flexible Relay Output 2	5A DC28V power supply output
Flexible Relay Output 3	5A DC28V power supply output
Flexible Relay Output 4	5A AC 250V volt free output
Flexible Relay Output 5	5A AC250V volt free output
Case Dimensions	HGM8140D: 136mm x110mmx41mm (panel-mount) HGM8140M: 150mmx104mmx41mm (mounted inside cabinet)
Panel Cutout	HGM8140D: 121mmx93mm
CT Secondary Current	Rated 5A
Working Temperature	(-40~+70)°C
Working Humidity	(20~93)%RH
Storage Temperature	(-40~+70)°C
Protection Level	IP65 when rubber seal installed between the controller enclosure and panel fascia.
Insulation Intensity	Apply AC2.2kV voltage between high voltage terminal and low voltage terminal. The leakage current is not more than 3mA within 1 min.
Weight	HGM8140D: 0.28kg HGM8140M: 0.43kg



## 4 OPERATION

### 4.1 KEY FUNCTION

**Table 3 Key Description**

Icons	Keys	Description
	Stop/Reset	Stop running genset in Auto/Manual mode; Reset alarms when genset in alarming status; Lamp test (press at least 3 seconds) in stop mode; During stopping process, press it again to stop genset immediately; Return back to homepage after press it in main interface and exist parameter settings after pressing it in parameter setting interface.
	Start	Start genset in <b>Manual</b> mode; jump to the next status in starting process.
	Manual Mode	Press this key and controller enters in <b>Manual</b> mode.
	Auto Mode	Press this key and controller enters in <b>Auto</b> mode.
	Close/Open	Close/Open breaker in manual mode. Reset "Trip" alarms for pressing over 3s.
	Menu/Confirm	Enter into menu interface; moving cursor to conform setting information in parameter setting interface.
	Up/Increase	1) Screen scroll; 2) Up cursor and increase value in setting menu.
	Down/Decrease	1) Screen scroll; 2) Down cursor and decrease value in setting menu.

**⚠CAUTION:** Default password is "0318", it is can be changed by the operator in case of other person adjust the advanced configuration of controller freely. Please keep the password in your mind after change it. If forget, please to contact with SmartGens's service personnel, and send all the information in the page of "Controller Information".

**⚠NOTE:** press any key can mute alarms.

## 4.2 CONTROLLER PANEL



**Fig. 1 HGM8140D Front Panel**

**NOTE:** Part of indicator lights illustration:

Alarm Indicators: slowly flash when warn alarms; fast flash when shutdown alarms; light is off when no alarms.

## 4.3 LCD DISPLAY

There are three display interfaces: default interface; OEM plant interface and terminal users interface. The default interface is unchangeable and the other two interfaces can be defined by the users. For example, main display content of default interface is as follows:

★**Main screen** show pages: use  to scroll the pages.

★**Home page**, including as below,  
Avg. phase voltage, frequency, max. current on load and etc.

★**Gen**, including as below,  
Phase voltage, Line voltage, frequency, phase sequence.

★**Load**, including as below,  
Current, each phase and total active power, total reactive power, total apparent power, and power factor.

★**Engine**, including as below,  
Speed, temperature of engine, engine oil pressure, liquid (fuel) level, battery voltage, charger voltage and etc.

★**Alarm**, including as below,  
All warning alarms and shutdown alarms are displayed.

```
Gens(L-L) 380 380 380V
Gens(L-N) 220 220 220V
GensFreq: 50.0Hz
Phase    0° 120° 240°
Stop mode
```

Fig.2 Gen Page Example

```
Amp    0.0 0.0 0.0 A
Power  0    0    0kW
Power  0.0kW    0.0kvar
PF    0.00    PS    0.0kVA
Stop mode
```

Fig.3 Load Page Example

## 4.4 AUTO START/STOP OPERATION

Press  , its indicator lights, and controller enters Auto mode.

### Starting Sequence,





- 1) HGM8140: Generator enters into “start delay” as soon as “Remote Start” input is active or DC input volt is below pre-set start volt.
- 2) Start Delay timer is shown on LCD.
- 3) When start delay is over, preheat relay outputs (if this be configured), “preheat start delay XX s” is shown on LCD.
- 4) When preheat delay is over, fuel relay outputs 1s and then start relay output; if engine crank fails during “cranking time”, the fuel relay and start relay deactivated and enter into “crank rest time” to wait for next crank.
- 5) If engine crank fails within setting times, the fifth line of LCD turn black and Fail to Start message appears on fifth line of LCD display at the same time.
- 6) In case of successful crank attempt, “safety on timer” starts. During this period, low oil pressure, high water temperature, under speed, charge failure alarms and auxiliary inputs (if configured) are disabled. As soon as this delay is over, “start idle delay” is initiated (if configured).
- 7) During “start idle delay”, under speed, under frequency, under voltage alarms are inhibited. When this delay is over, “warming up delay” starts (if configured).
- 8) When “warming up delay” is over, if generator state is normal, its indicator will be illuminated. If voltage and frequency has reached on-load requirements, the closing relay will be energized, generator will accept load, generator power indicator will turn on, and generator will enter Normal Running state; if voltage and frequency are abnormal, the controller will initiate shutdown alarm (shutdown alarm will be displayed on LCD alarm page).

### Stopping Sequence:



- 1) HGM8140: Generator enters into “stop delay” as soon as “Remote Start on Load” is inactive and DC input volt exceeds pre-set shutdown voltage.
- 2) When stop delay is over, close generator relay is un-energized; generator enters into “cooling down time”. After “transfer rest time”, close mains relay is energized. Mains on load and generator indicator extinguished while mains indicator lights.
- 3) Idle relay is energized as soon as entering “stop idle delay” (if configured).
- 4) If enter “ETS hold delay”, ETS relay is energized. Fuel relay is deactivated.
- 5) Then enter gen-set “Fail to stop time”, auto decides whether generator is stopped or not automatically.

- 6) Enter "generator at rest" as soon as "after stop time" is over. If genset fail to stop, controller will initiate alarms (fail to stop warning shown on LCD).

## 4.5 MANUAL START/STOP OPERATION

- 1) **HGM8140:** Manual mode is selected by pressing the  button; a LED besides the button will illuminate to confirm the operation; press  button to start the genset, it can automatically judge crank success and accelerate to high speed running. If high temperature, low oil pressure, over speed and abnormal voltage occur during genset running, controller can effectively protect genset to stop (detail procedures please refer to No.5~8 of Auto start sequence). After genset is normal running, press  button, and genset on load
- 2) Manual stop: pressing  key can stop the running genset. (detail procedures please refer to No.4~6of Auto stop sequence)

## 4.6 EMERGENCY START UP

Simultaneously press  and  or in manual mode will force generator to crank. Successful start will not be judged according to crank disconnect conditions, operator will have to crank the starter motor manually; when operator decides that the engine has fired, he/she should release the button or disconnect manual force to start input and start output will be deactivated, safety on delay will be initiated.

5 PROTECTION

5.1 WARNINGS

When controllers detect the warning signals, alarm only and not stop the genset, besides, the LCD displays the warning information.

**Table 4 Controller Warning Alarms**

No.	Type	Description
1	Loss of Speed Signal	When the controller detects that the engine speed is 0 and the delay is 0, it will initiate a warning alarm and the corresponding alarm information will be displayed on LCD.
2	Gen Over Current	When the controller detects that the genset current has exceeded the pre-set value (action selected warning), it will initiate a warning alarm and the corresponding alarm information will be displayed on LCD.
3	Fail to Stop	After "Fail to stop" delay/ETS delay has expired, if gen-set does not stop completely, it will initiate a warning alarm and the corresponding alarm information will be displayed on LCD.
4	Low Fuel Level	When the controller detects that the fuel level has fallen below the pre-set value or low fuel level input is active, it will initiate a warning alarm and the corresponding alarm information will be displayed on LCD.
5	Charge Alt. Failure	When the controller detects that charger voltage has fallen below the battery voltage, it will initiate a warning alarm and the corresponding alarm information will be displayed on LCD.
6	Battery Under Volt	When the controller detects that genset battery voltage has fallen below the pre-set value, it will initiate a warning alarm and the corresponding alarm information will be displayed on LCD.
7	Battery Over Volt	When the controller detects that genset battery voltage has exceeded the pre-set value, it will initiate a warning alarm and the corresponding alarm information will be displayed on LCD.
8	Low Coolant Level	When the controller detects the low coolant level input is active, it will initiate a warning alarm and the corresponding alarm information will be displayed on LCD.
9	Temp. Sensor Open Circuit	When the controller detects that the temperature sensor is open circuit and the action select "Warn", it will initiate a warning alarm and the corresponding alarm information will be displayed on LCD.
10	Oil Pressure Sensor Open Circuit	When the controller detects that the oil pressure sensor is open circuit and the action select "Warn", it will initiate a warning alarm and the corresponding alarm information will be displayed on LCD.
11	Maintenance Due	Maintenance type can be set as genset running time, or date. when genset running time has exceeded the user setting maintenance time or the current date is over the setting date, it will initiate a warning alarm and the corresponding alarm information will be displayed on LCD.

No.	Type	Description
12	High Temperature	When it is enabled and the controller detects that config. sensor temperature (sensor type: temperature sensor) has exceeded the pre-set value, it will initiate a warning alarm and the corresponding alarm information will be displayed on LCD.
13	Low Oil Pressure	When it is enabled and the controller detects that config. sensor oil pressure (sensor type: oil pressure sensor) has fallen below the pre-set value, it will initiate a warning alarm and the corresponding alarm information will be displayed on LCD.
14	Digital Input	When the switching input is selected as user-defined and action is warning, when input port is active, the controller will initiate corresponding warning alarms.
15	Fail to Charge	When controller detects the fail to charge warn input is active, it will send alarm signals and the corresponding alarm information will be displayed on LCD.
16	Over Power	When controller detects the genset power value (power is positive) is higher than the set value and the action select warn, it will send warn signals.
17	ECU Warn	When controller gets the warn signals from engine via J1939, it will send warn signals.
18	RS232 Communication Fail	When multi display modules are connected and RS232 port communication fail warning is active, controller will initiate warning alarms if RS232 port display fail to communication, and the corresponding information will displayed on the LCDs of other CAN port display modules.
19	CAN Exp. Communication Fail	When multi display modules are connected and CAN Expansion displays communication fail warning is active, controller will initiate warning alarms if CAN display module fail to communication, and the corresponding information will displayed on the LCDs of other display modules.
20	Flexible Sensor 1 Open	When the controller detects that the sensor is open circuit and the action select "Warn", it will initiate a warning alarm and the corresponding alarm information will be displayed on LCD.
21	Flexible Sensor 1 High	When it is enabled, and controller detects the sensor value is higher than the setting threshold value, controller will initiate warning signals.
22	Flexible Sensor 1 Low	When it is enabled, and controller detects the sensor value is lower than the setting threshold value, controller will initiate warning signals.
23	Reverse Power	When reverse power detection is active, and controller detects the reverse power value of genset(power is negative) is over than setting threshold, and selection is warn, controller will initiate warning signals.
24	High Temp. Input	When it is enabled and high temperature shutdown is prohibited or high temperature of input port shutdown is prohibited, controller will initiate a warning alarm and the corresponding alarm information will be displayed on LCD.
25	Low Oil Pressure	When it is enabled and low oil pressure shutdown is prohibited or low

No.	Type	Description
	Input	oil pressure of input port shutdown is prohibited, controller will initiate a warning alarm and the corresponding alarm information will be displayed on LCD.
26	Gen Over Volt	When controller detects genset voltage is higher than the pre-set warning value, it will issue warning signal.
27	Gen Under Volt	When controller detects genset voltage is less than the pre-set warning value, it will issue warning signal.
28	Gen Over Freq	When controller detects genset frequency is higher than the pre-set warning value, it will issue warning signal.
29	Gen Under Freq	When controller detects genset frequency is less than the pre-set warning value, it will issue warning signal.
30	Fuel Pump Fault	When fuel pump outputs, if controller can't detect fuel level change during set fuel pump detecting time, it will issue warning signal.

## 5.2 TRIP ALARM

On initiation of the trip condition the controller will de-energize the 'Close Generator' Output without stop the generator.

**Table 5 Controller Trip Alarms**

No.	Type	Description
1	Gen Over Current	When the controller detects that the genset current has exceeded the pre-set value and the action select "Trip", it will initiate a trip alarm.
2	Reverse Power	If reverse power detection is enabled, when the controller detects that the reverse power value (power is negative) has fallen below the pre-set value and the action select "Trip", it will initiate a trip alarm.
3	Over Power	If over power action type is set as trip, when the controller detects that the over power value (power is positive) has exceeded the pre-set value, it will initiate a trip alarm.
4	Digital Input	When digit input port is selected as user-defined and it is set as "Trip" and the alarm is active, it will initiate a trip alarm.
5	Over Voltage	If gen over voltage action type is set as trip, when controller detects that genset voltage has fallen below the pre-set value, it will initiate a trip alarm.
6	Under Voltage	If gen under voltage action type is set as trip, when controller detects that genset voltage has exceeded the pre-set value, it will initiate a trip alarm.
7	Over Frequency	If gen over frequency action type is set as trip, when controller detects that genset frequency has exceeded the pre-set value, it will initiate a trip alarm.
8	Under Frequency	If gen under frequency action type is set as trip, when controller detects that genset frequency has fallen below the pre-set value, it will initiate a trip alarm.

**5.3 TRIP AND STOP ALARMS**

When controller detects shutdown alarm, it will send signal to open breaker and shuts down generator, and alarms type will be displayed on the LCD.

**Table 6 Controller Trip & Stop Alarms**

No.	Type	Description
1	Gen Over Current	When the controller detects that the genset current has exceeded the pre-set value and the action select "Trip and Stop", it will initiate a trip and stop alarm.
2	Reverse Power	If reverse power detection is enabled, when the controller detects that the reverse power value (power is negative) has fallen below the pre-set value and the action select "Trip and Stop", it will initiate a trip and stop alarm.
3	Over Power	If over power detection is enabled, when the controller detects that the over power value (power is positive) has exceeded the pre-set value and the action select "Trip and Stop", it will initiate a trip and stop alarm.
4	Digital Input	When digit input port is selected as user-defined and it is set as "Trip and Stop" and the input is enabled, it will initiate a trip alarm.

**5.4 SHUTDOWN ALARMS**

When controller detects shutdown alarm, it will send signal to open breaker and shuts down generator, and alarms type will be displayed on the LCD.

**Table 7 Controller Shutdown Alarms**

No.	Type	Description
1	Emergency Stop	When the controller detects an emergency stop alarm signal, it will initiate a shutdown alarm, and the corresponding shutdown alarm information will be displayed on LCD.
2	High Temperature	When high temperature shutdown alarm is enabled, and controller detects temperature value is higher than the set value, it will send stop signals and the corresponding alarm information will be displayed on LCD.
3	Low Oil Pressure	When low oil pressure shutdown alarm is enabled, and controller detects oil pressure is lower than the set value, it will send stop signals and the corresponding alarm information will be displayed on LCD.
4	Over Speed	When controller detects the speed value is higher than the set value, it will send stop signals and the corresponding alarm information will be displayed on LCD.
5	Under Speed	When controller detects the speed value is lower than the set value, it will send stop signals and the corresponding alarm information will be displayed on LCD.
6	Loss of Speed Signal	When controller detects speed value equals to 0, and delay value isn't 0 (action select "Shutdown"), it will send stop signals and the



No.	Type	Description
		corresponding alarm information will be displayed on LCD.
7	Gen Over Voltage	When controller detects the voltage value is higher than the set value, it will send stop signals and the corresponding alarm information will be displayed on LCD.
8	Gen Under Voltage	When controller detects the frequency value is lower than the set value, it will send stop signals and the corresponding alarm information will be displayed on LCD.
9	Gen Over Current	When controller detects the current value is higher than the set value and the delay value is not 0, it will send stop signals and the corresponding alarm information will be displayed on LCD.
10	Fail to Start	If genset start failure within setting of start times, controller will send stop signals and the corresponding alarm information will be displayed on LCD.
11	Gen Over Frequency	When controller detects the frequency value is higher than the set value, it will send stop signals and the corresponding alarm information will be displayed on LCD.
12	Gen Under Frequency	When controller detects the frequency value is lower than the set value, it will send stop signals and the corresponding alarm information will be displayed on LCD.
13	No Power Supply	When controller detects genset frequency is 0, it will initiate shutdown alarm and corresponding alarm information will be displayed on LCD.
14	Low Fuel Level	When controller detects fuel level value lower than the pre-set value and the low fuel level input is enabled, controller send stop signals and the corresponding alarm information will be displayed on LCD.
15	Low Coolant Level	When controller detects low coolant level input is active, controller send stop signals and the corresponding alarm information will be displayed on LCD.
16	Temp. Sensor Open Circuit	When controller detects sensor, which connected to temperature sensor, is open circuit, it will send stop signals and the corresponding alarm information will be displayed on LCD.
17	Oil Pressure Sensor Open Circuit	When controller detects sensor, which connected to oil pressure sensor, is open circuit, it will send stop signals and the corresponding alarm information will be displayed on LCD.
18	Maintenance Due	Maintenance type can be set as genset running time, or date. When genset running time has exceeded the user setting maintenance time or the current date is over the setting date, and the action is "Shutdown", controller will initiate a warning alarm and the corresponding alarm information will be displayed on LCD. Setting maintenance parameter after filling in the password can restore maintenance alarm.
19	Digital Input	When digit input port is selected as user-defined and it is set as "Shutdown Alarm" and the input is enabled, it will initiate a shutdown alarm and corresponding information will be displayed on the LCD.
20	Over Power	When controller detects the power value (power is positive) is higher

No.	Type	Description
		than the max. set value and the action select "shutdown", it will send stop signals.
21	Reverse Power	When controller detects the reverse power value (power is negative) is higher than the max. set value and the action select "shutdown", it will send stop signals.
22	ECU Alarm Shutdown	After engine start, controller receives data signals, via J1939, controller send stop signals.
23	ECU Comm. Fail	After engine start, controller dose not receive data signals, via J1939, controller send stop signals.
24	Flexible Sensor 1 Open Circuit	When the controller detects that the sensor is open circuit and the action select "Shutdown Alarm", it will initiate a shutdown alarm and the corresponding alarm information will be displayed on LCD.
25	Flexible Sensor 1 High	When it is enabled, and controller detects the sensor value is higher than the setting threshold value, controller will initiate shutdown alarm signals.
26	Flexible Sensor 1 Low	When it is enabled, and controller detects the sensor value is lower than the setting threshold value, controller will initiate shutdown alarm signals.
27	High Temp. Shutdown Input	When it is enabled, controller will initiate a shutdown alarm signals and the corresponding alarm information will be displayed on LCD.
28	Low Oil Pressure Shutdown Input	When it is enabled, controller will initiate a shutdown alarm signals and the corresponding alarm information will be displayed on LCD.

**▲NOTE:** ECU warns and shutdown alarms illustration, if there are detailed alarms display, controller will check engine based on the content. Otherwise, please look up engine Manuel to get the information based on the SPN code.

6 WIRINGS CONNECTION

6.1 HGM8140M GENSET CONTROLLER PANEL

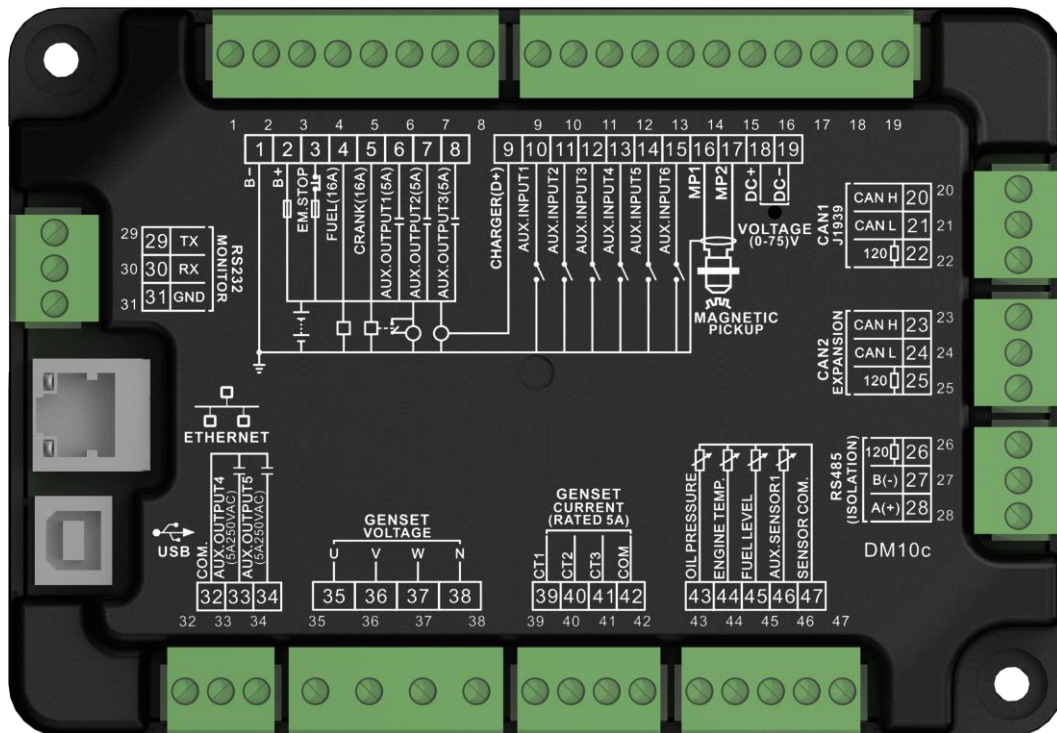

Fig.4 HGM8140M Controller Panel

Table 8 Terminal Wiring Connection Description

No.	Function	Cable Size	Remarks	
1	B-	2.5mm <sup>2</sup>	Connected with negative of starter battery.	
2	B+	2.5mm <sup>2</sup>	Connected with positive of starter battery. If wire length is over 30m, better to double wires in parallel. Max. 20A fuse is recommended.	
3	Emergency Stop	2.5mm <sup>2</sup>	Connect with B+ via emergency stop button.	
4	Fuel Relay Output	1.5mm <sup>2</sup>	B+ is supplied by 3 terminal, rated 16A .	
5	Start Relay Output	1.5mm <sup>2</sup>	B+ is supplied by 3 terminal, rated 16A. Connect with boost coil of starter.	
6	Aux. Output 1	1.5mm <sup>2</sup>	B+ is supplied by 2 terminal, rated 7A.	
7	Aux. Output 2	1.5mm <sup>2</sup>	B+ is supplied by 2 terminal, rated 7A.	
8	Aux. Output 3	1.5mm <sup>2</sup>	B+ is supplied by 2 terminal, rated 7A.	
9	Charger(D+)	1.0mm <sup>2</sup>	Connected with charger starter's D+ (WL) terminals. Being hang up If there is no this terminal.	
10	Aux. Input 1	1.0mm <sup>2</sup>	Grounding (B-) is active.	Setting items please to see Table 12.
11	Aux. Input 2	1.0mm <sup>2</sup>	Grounding (B-) is active.	
12	Aux. Input 3	1.0mm <sup>2</sup>	Grounding (B-) is	

No.	Function	Cable Size	Remarks
			active.
13	Aux. Input 4	1.0mm <sup>2</sup>	Grounding (B-) is active.
14	Aux. Input 5	1.0mm <sup>2</sup>	Grounding (B-) is active.
15	Aux. Input 6	1.0mm <sup>2</sup>	Grounding (B-) is active.
16	Speed Sensor Input		Connect with speed sensor, shielded wire is recommended.
17	Speed Sensor Input, (internal of controller connect with battery negative electrode.)	0.5mm <sup>2</sup>	
18	DC Volt	DC+ 1.0mm <sup>2</sup>	DC(0-75)V input
19	Monitoring Input	DC- 1.0mm <sup>2</sup>	
20	CAN1	CAN H	120Ω shielded wire is recommended, single end is GND connected; Short connect Terminal 20 and 22 and connect to 120Ω terminal resistor.
21		CAN L	
22		120Ω	
23	CAN2	CAN H	120Ω shielded wire is recommended, single end is GND connected; Short connect Terminal 23 and 25 and connect to 120Ω terminal resistor.
24		CAN L	
25		120Ω	
26	RS485	120Ω	120Ω shielded wire is recommended, single end is GND connected; Short connect Terminal 26 and 28 and connect to 120Ω terminal resistor.
27		B(-)	
28		A(+)	
29	RS232	TX	Connect with HGM8140D monitoring module.
30		RX	
31		GND	
32	Relay Output COM	2.5mm <sup>2</sup>	Relay normally open, volt free, rated 5A, volt free output.
33	Aux. Relay Output 4	2.5mm <sup>2</sup>	
34	Aux. Relay Output 5	2.5mm <sup>2</sup>	
35	Genset U-phase voltage monitoring input	1.0mm <sup>2</sup>	Connected to U-phase output of genset (2A fuse recommended).
36	Genset V-phase voltage monitoring input	1.0mm <sup>2</sup>	Connected to V-phase output of genset (2A fuse recommended).
37	Genset W-phase voltage monitoring input	1.0mm <sup>2</sup>	Connected to W-phase output of genset (2A fuse recommended).
38	Genset N-wire Input	1.0mm <sup>2</sup>	Connected to N-wire output of genset.
39	CT A-phase monitoring input	1.5mm <sup>2</sup>	Outside connected to secondary coil of CT (5A rated).

No.	Function	Cable Size	Remarks
40	CT B-phase monitoring input	1.5mm <sup>2</sup>	Outside connected to secondary coil of CT (5A rated).
41	CT C-phase monitoring input	1.5mm <sup>2</sup>	Outside connected to secondary coil of CT (5A rated).
42	CT Common Ground	1.5mm <sup>2</sup>	Details to see <b><i>Installation Instructions.</i></b>
43	Oil Pressure Sensor Input	1.0mm <sup>2</sup>	Connected to oil pressure resistor sensor.
44	Temp. Sensor Input	1.0mm <sup>2</sup>	Connected to water/cylinder temp. resistor sensor.
45	Level Sensor Input	1.0mm <sup>2</sup>	Connected to liquid level resistor type sensor.
46	Aux. Sensor 1 Input	1.0mm <sup>2</sup>	Connected to users-defined resistor type sensor.
47	Sensor Common	1.0mm <sup>2</sup>	Internally disconnected with B-

Setting items please to see *Table 13.*

**▲NOTE:** USB ports in controller rear panel are programmable parameter ports, user can directly configure controller via PC.

6.2 HGM8140D GENSET CONTROLLER BACK PANEL

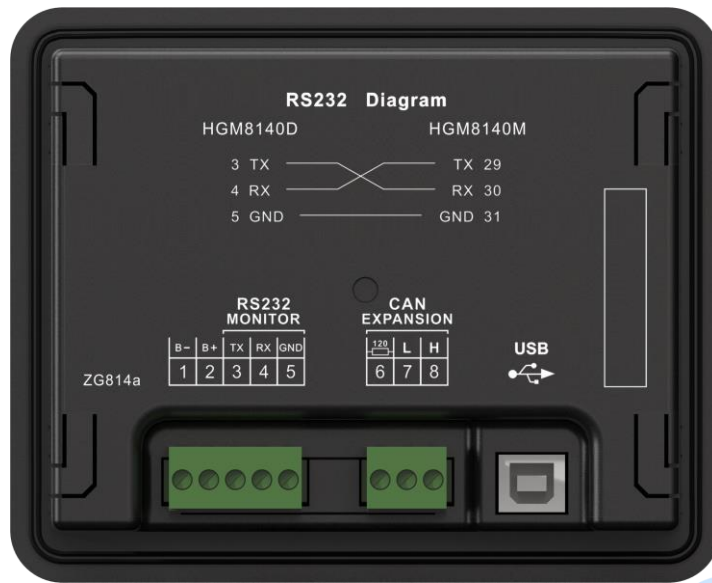

Fig.5 HGM8140D Back Panel

Table 9 Terminal Wiring Description

No.	Function		Cable Size	Remarks
1	B-		2.5mm <sup>2</sup>	Connected with negative of starter battery.
2	B+		2.5mm <sup>2</sup>	Connected with positive of starter battery. If wire length is over 30m, better to double wires in parallel. Max. 20A fuse is recommended.
3	RS232	TX	0.5mm <sup>2</sup>	Connected with HGM8140M module.
4		RX	0.5mm <sup>2</sup>	
5		GND	0.5mm <sup>2</sup>	
6	SCR		/	Connected with HGM8140M module.
7	CAN	CANL	1.0mm <sup>2</sup>	
8		CANH	1.0mm <sup>2</sup>	

7 SCOPS AND DEFINITIONS OF PROGRAMMABLE PARAMETERS

7.1 CONTENTS AND SCOPES OF PARAMETERS

Table 10 Parameters Settings and Scope

No.	Items	Parameters	Defaults	Description
01	Start Delay	(0~3600)s	1	Time from mains abnormal or remote start signal is active to start genset.
02	Stop Delay	(0~3600)s	1	Time from mains normal or remote start signal is inactive to stop genset.
03	Start	(1-10) times	3	Max. start times if crank unsuccessfully. When start times reach to the max. value, fail to start signal will be initiated by controller.
04	Pre-heat Delay	(0~300)s	0	Time of pre-powering heat plug before starter is powered up.
05	Cranking Time	(3~60)s	8	Time of starter power on
06	Crank Rest Time	(3~60)s	10	The waiting time before second power up when engine start fail.
07	Safety On Delay	(1-60)s	10	Alarms for low oil pressure, high temperature, under speed, under frequency /voltage, charge fail are inactive.
08	Start Idle Time	(0~3600)s	0	Idle running time of genset when starting.
09	Warming Up Time	(0~3600)s	10	Warming up time between genset switch on and high speed running.
10	Cooling Time	(3~3600)s	10	Radiating time before genset stop, after it unloads.
11	Stop Idle Time	(0~3600)s	0	Idle running time when genset stop.
12	ETS Solenoid Hold	(0~120)s	20	Stop electromagnet's power on time when genset is stopping.
13	Fail to Stop Delay	(0~120)s	0	Time between ending of genset idle delay and stopped when "ETS time" is set as 0; Time between ending of ETS hold delay and stopped when "ETS Hold output time" is not 0.
14	Switch Close Time	(0-10.0)s	5.0	Gen/Mains close pulse width, and 0s means continuously output.
15	Flywheel Teeth	(10.0~300.0)	118.0	Tooth number of the engine, for judging of starter separation conditions and inspecting of engine speed. See the installation instructions.
16	Gen Abnormal Delay	(0-20.0)s	10.0	Alarm delay of generator over voltage and under voltage.
17	Gen Over Volt	(30-620)V	264	When generator voltage has exceeded the

No.	Items	Parameters	Defaults	Description
	Shutdown			set value and the "Gen abnormal delay" has expired, Gen Over Voltage Shutdown alarm is active. When set the value as 620V, the controller does not detect over voltage signal.
18	Gen Under Volt Shutdown	(30-620)V	196	When generator voltage has fallen below the set value and the "Gen abnormal delay" has expired, Gen Under Voltage Shutdown is active. When set the value as 30V, the controller does not detect under voltage signal.
19	Under Speed Shutdown	(0-6000)RPM	1200	When engine speed has fallen below the set value for 10s, Under Speed is active. It will initiate a shutdown alarm signal.
20	Over Speed Shutdown	(0-6000) RPM	1710	When engine speed has exceeded the set value for 2s, Over Speed is active. It will initiate a shutdown alarm signal.
21	Under Shutdown Freq	(0-75.0)Hz	45.0	When generator frequency has fallen below the set value but Not equal to 0 for 10s, Under Frequency is active. It will initiate a shutdown alarm signal.
22	Over Shutdown Freq	(0-75.0)Hz	57.0	When generator frequency has exceeded the set value for 2s, Over Frequency is active. It will initiate a shutdown alarm signal.
23	High Shutdown Temp.	(0-300)°C	98	When the temperature value of the external temperature sensor exceeds the set value, "High Temperature" timer is initiated. Detecting only after safety on delay has expired. (this only concerns external temperature sensor).
24	Low Oil Pressure Shutdown	(0-1000)kPa	103	When the external pressure sensor value falls below this set value, "Low Oil Pressure" timer is initiated. Detecting only after safety on delay has expired. If the set value is 0, low oil pressure signal will not be sent (this only concerns pressure sensor and does not concern low oil pressure warning signal via configurable input port)
25	Low Fuel Level	(0-100)%	10	When the liquid level of the external sensor falls below the set value and lasts more than 10s, "Low Fuel Level" signal is initiated. (it is warning only)
26	Loss of Speed	(0-20.0)s	5.0	If the set value is 0, only warning and not to



No.	Items	Parameters	Defaults	Description
	Signal			shut down the generator.
27	Charge Alternator Failure	(0-30)V	6.0	During generator is normal running, when alternator D+(WL) voltage has fallen below the set value and remains for 5s, It will initiate a shutdown alarm signal.
28	Battery Voltage Over	(12-40)V	33.0	When battery voltage has exceeded the set value and remains for 20s, it will initiate a warning alarm signal. Only warning and not to shut down the generator.
29	Battery Voltage Under	(4-30)V	8.0	When battery voltage has fallen below the set value and remains for 20s, it will initiate a warning alarm signal. Only warning and not to shut down the generator.
30	Current Transformer	(5-6000)/5	500	The ratio of external CT.
31	Full Load Rating	(5-6000)A	500	Generator's rated current, used for load over current calculating.
32	Over Current Percentage	(50-130)%	120	When the load current has exceeded the set value, "over current" delay is initiated.
33	Over Current Delay	(0-3600)s	30	Definite time-lag delay value. When load current has exceeded the set value and the "over current" delay has expired, over current alarm is initiated. When the set value is 0, only warning and not to shut down the generator.
34	Fuel Pump On	(0-100)%	25	When fuel level has fallen below the set value for 10s, "Fuel Pump On" alarm is initiated.
35	Fuel Pump Off	(0-100)%	80	When fuel level has exceeded the set value for 10s, "Fuel Pump Off" alarm is initiated.
36	Relay Output 1	(0-99)	2	Factory default: Energized To Stop, details to see <i>Table 11</i> .
37	Relay Output 2	(0-99)	3	Factory default: Idle Speed Control, details to see <i>Table 11</i> .
38	Relay Output 3	(0-99)	5	Factory default: Close Generator, details to see <i>Table 11</i> .
39	Relay Output 4	(0-99)	6	Factory default: Reserved, details to see <i>Table 11</i> .
40	Relay Output 5	(0-99)	00	Factory default: Not Used, details to see <i>Table 11</i> .
41	Digital Input 1	(0-31)	1	Factory default: High Temperature Alarm Input, details to see <i>Table 12</i> .
42	Digital Input 1 Delay	(0-20.0)s	2.0	

No.	Items	Parameters	Defaults	Description
43	Digital Input 2	(0-31)	2	Factory default: Low Oil Pressure Warning Input, details to see <i>Table 12</i> .
44	Digital Input Delay 2	(0-20.0)s	2.0	
45	Digital Input 3	(0-31)	10	Factory default: Remote Start Input, details to see <i>Table 12</i> .
46	Digital Input Delay 3	(0-20.0)s	2.0	
47	Digital Input 4	(0-31)	11	Factory default: Low Fuel Level Warn, details to see <i>Table 12</i> .
48	Digital Input Delay 4	(0-20.0)s	2.0	
49	Digital Input 5	(0-31)	12	Factory default: Low Coolant Level Warn, details to see <i>Table 12</i> .
50	Digital Input Delay 5	(0-20.0)s	2.0	
51	Digital Input 6	(0-31)	0	Factory default: User-defined, details to see <i>Table 12</i> .
52	Digital Input Delay 6	(0-20.0)s	2.0	
53	High Temp Warning	(0-300)°C	95	When the external temperature sensor value exceeds this set value, "High Temp Warning" timer is initiated. Detecting only after safety on delay has expired. Return value (default: 93) and delay value (default: 5s) also can be set.
54	Low Oil Pressure Warning	(0-1000)kPa	124	When the external oil pressure sensor value falls below this set value, "Low Oil Pressure Warning" timer is initiated. Detecting only after safety on delay has expired. Return value (default: 138) and delay value (default: 5s) also can be set.
55	Power On Mode	(0-2)	0	0: Stop Mode 1: Manual Mode 2: Auto Mode
56	Module Address	(1-254)	1	Communication address of controller.
57	Passwords	(0-9999)	0318	Details to see <i>Note 4</i>
58	Crank Disconnect	(0-6)	2	There are 3 conditions of disconnecting starter with engine: Generator Frequency, Speed, and Oil Pressure. Aiming to separating the start motor and genset as soon as possible.
59	Disconnect Gen Speed	(0-3000)RPM	360	When generator speed is higher than the set value, starter will be disconnected.

No.	Items	Parameters	Defaults	Description
60	Disconnect Gen Frequency	(10-30)Hz	14	When generator frequency higher than the set value, starter will be disconnected.
61	Disconnect Engine Oil Pressure	(0-400)kPa	200	When generator oil pressure higher than the set value, starter will be disconnected.
62	High Temp. Shut Inhibit Enabled	(0-1)	0	Factory default: when high temperature occurs, shutdown alarm is initiated. Note 2
63	Low OP Shut Inhibit Enabled	(0-1)	0	Factory default: when low oil pressure occurs, shutdown alarm is initiated. Note 3
64	AC System	(0-3)	0	0: 3P4W; 1: 2P3W 2: 1P2W; 3: 3P3W
65	Temperature Sensor Curve	(0-12)	8	SGX, details to see <i>Table 13</i> .
66	Pressure Sensor Curve	(0-12)	8	SGX , details to see <i>Table 13</i> .
67	Fuel Level Sensor Curve	(0-7)	3	SGD, details to see <i>Table 13</i> .
68	Poles	(2-64)	4	Number of generator poles, which can be used to speed calculating for gens without speed sensors.
69	Temp. Sensor Open Circuit Action	(0-2)	1	0:Not used ; 1:Warn; 2:Shutdown
70	Oil Pressure Sensor Open Circuit Action	(0-2)	1	When disconnect conditions include oil pressure and engine oil pressure is higher than disconnect oil pressure delay, the genset is regarded as start successfully and starter will disconnect.
71	Disconnect Oil Pressure Delay	(0-20.0)s	0.0s	When crank disconnect condition conclude oil pressure, if engine oil pressure and delay value exceed pre-set crank disconnect values, genset start successfully and starter will disconnect.
72	Scheduled Run	(0-1)	0	0: Disabled; 1:Enabled
73	Scheduled Period	(0-1)	0	Monthly, weekly and daylily can be optional, Start time and duration time can be adjusted.
74	Auto Start Inhibited	(0-1)	0	0: Disabled; 1:Enabled
75	Auto Start Inhibited	(0-2)	0	Monthly, weekly and daylily can be optional, Prohibit start time and duration time can be adjusted.
76	Over Power Set	(0-4)	1	0 Inactive; 1 Warning; 2 Shutdown; 3: Trip and Stop; 4: Trip. When the power exceeds preset limit, and the duration is greater than the delay value, over power alarm is active. Both return

No.	Items	Parameters	Defaults	Description
				value and delay value can be set.
77	Boot Screen	(0-1)	0	0: Disenable 1: Enable Boot Interface delay can be adjusted
78	Maintenance Password	(0-9999)	0	Password to enter into the maintenance setting page.
79	Date Setting	Controller's date setting		
80	Custom Sensor Curve	(0-3)	0	0 Not used; 1 Custom temperature sensor; 2 Custom pressure sensor; 3 Custom level sensor; Choose sensor which need to be set, input every point (8 points need to be input) resistance and corresponding value(or current, voltage) of curve.
81	Engine Type	(0-39)	0	Conventional J1939 engine.
82	SPN Alarming Version	(0-3)	0	Alarming Version 1.
83	Custom Theme	(0-2)	0	0: Default Theme; 1: OEM plant Theme; 2: Terminal Users Theme.
84	RS232 Display	(0-1)	1	0: Disabled; 1: Enabled; Enable control and comm. failed warning enable both can be set.
85	CAN-1 Display	(0-1)	1	0: Disabled; 1: Enabled; Enable control and comm. failed warning enable both can be set.
86	CAN-2 Display	(0-1)	0	0: Disabled; 1: Enabled; Enable control and comm. failed warning enable both can be set.
87	CAN-3 Display	(0-1)	0	0: Disabled; 1: Enabled; Enable control and comm. failed warning enable both can be set.
88	Reverse Power	(0-4)	0	0: Inactive; 1: Warning; 2: Shutdown; 3: Trip and Stop; 4: Trip. When power is negative, and larger than the set, and this lasts for over delay time, this alarm is active. Return value and delay value can be set.
89	Aux. Sensor 1	(0-3)	0	0: Not Used; 1: Temperature Sensor; 2: Pressure Sensor; 3: Fuel Level Sensor;
90	Gen Over Volt. Warning	(30-620)V	253	When gen voltage is higher than this and lasts for 5s, over voltage is considered and over volt warning is initiated. When it is set

No.	Items	Parameters	Defaults	Description
				to 620V, over voltage signal is not detected.
91	Gen Under Volt Warning	(30-620)V	193	When sample voltage is lower than this and lasts for 5s, under voltage is considered and under volt warning is initiated. When it is set to 30V, under voltage signal is not detected.
92	Gen Over Freq. Warning	(0-75.0)Hz	55.0	When gen freq. is higher than this and last for 5s, over freq. is considered and over freq. warning is initiated.
93	Gen Under Freq. Warning	(0-75.0)Hz	42.0	When gen freq. is lower than this, but not 0 and lasts for 5s, under freq. is considered and under freq. alarm is initiated.
94	Cycle Start Enable	(0-1)	0	0: Disabled; 1: Enabled.
95	Master Select	(0-1)	0	0: Slave; 1: Master.
96	Cycle Time Enable	(0-1)	0	0: Disabled; 1: Enabled. Cycle run time enable setting.
97	Master Run Time	(0-1440)min	720	When cycle run time is enabled, the time for cycle run of master and slave set.
98	Slave Run Time	(0-1440)min	720	
99	Max. Pump Output Time	(0-3600)min	60	When fuel pump outputs, if continuous output time exceeds the set value, turn off the pump.
100	Cycle Port Select	(0-1)	0	0: CAN; 1: TCP/IP.
101	ECU Comm. Address	(0-255)	3	ECU communication address.
102	Rated Speed	(0-6000)RPM	1500	Engine rated speed setting.
103	Idling Speed Set	(0-6000)RPM	750	Engine idling speed setting.
104	Speed Sampling	(0-1)	0	0: Controller Sampling; 1: ECU Sampling. It needs to be set via upper computer.
105	Fuel Pump Detect Time	(0-3600)min	1	It needs to be set via upper computer.

**NOTE1:** If "high temperature inhibit" is configured, or set auxiliary input as "inhibit high temperature stop" and this input is active, when temperature is higher than the preset value, or high temperature alarm input is active, controller will send warning signal only and not stop the unit.

**NOTE2:** If "low oil pressure inhibit" is configured, or set auxiliary input as "inhibit low oil pressure stop" and this input is active, when oil pressure is lower than the preset value, or low oil pressure alarm input is active, controller will send warning signal only and not stop the unit.

**NOTE3:** If default password (0318) isn't changed, it doesn't need to input when configuring parameters via PC software; if the password is changed for the first time via PC software, it need to input password in password window.

**NOTE4:** Between input correct password and LCD back light haven't got dark, input parameter numbers can enter parameter setting interface when enters "Password Input" again.

**NOTE5:** In teeth configuration interface, configure teeth status and power large than 20Hz, press start key for auto calculating teeth numbers and press confirm key for changing teeth numbers.

**Table 11 Relay Output Port 1-4 Contents**

No.	Item	Description
00	Not Used	Output port is deactivated when "Not Used" is selected.
01	Common Alarm	Include all shutdown alarms and warning alarms. When there is warning alarm only, it is not self-lock; when a shutdown alarm occurs, it is self-lock until the alarm is reset.
02	Energize to Stop	Suitable for genset with electromagnet and will active after "stop idle delay". It is deactivated when the "ETS Solenoid delay" expires.
03	Idle Control	Used for engine which has idles. Close before starting and open in warming up delay; Close during stop idle delay and open when stop is completed.
04	Preheat Control	Close before starting and open before power up.
05	Close Gen Output	When close time is 0, it's continuous output.
06	Reserved	
07	Breaker Open	When close time is 0, it's disabled.
08	Speed Raise Relay	Close when the generator enters into Warming Up delay (close time: Warming Up Delay).
09	Speed Drop Relay	Close when the generator enters into Stop Idle delay/Energized to Stop delay (close time: Stop Idle Delay).
10	Run Output	Action when genset is normal running while deactivated when engine speed is lower than the "crank disconnect speed".
11	Fuel Pump Control	Close when fuel level is lower than the "Fuel Pump On" value or when low fuel level warning input is active; Open when fuel level is higher than the "Fuel Pump Off" and low fuel level warning input is deactivated;
12	High Speed Control	Close when the generator enters into Warming Up delay while open after cooling delay.
13	Auto Mode	The controller is in automatic mode.
14	Shutdown Alarm	Output when shutdown alarms appears.
15	Audible Alarm	When warning and shutdown alarms appear, audible alarm output is fixed as 300s. When "alarm mute" or any keys on the panel configurable input port is active, it can remove the alarm.
16	Heater Control	Controlled by the upper or lower limit of temperature sensor.
17	Fuel Output	Activate when genset start, and break off when waiting for stop steady.
18	Start Output	Genset output only in crank output status.
19	ECU Stop	Apply for engine with electronic injection ECU, which is used for controlling ECU shutdown.
20	ECU Power Supply	Apply for engine with electronic injection ECU, which is used for controlling ECU power supply.
21	ECU Warning	It is indicate that ECU has sent a warning alarm signal.
22	ECU Shutdown	It is indicate that ECU has sent a shutdown alarm signal.

No.	Item	Description
23	ECU Communication Failure	It is indicate that controller cannot communicate with ECU.
24	Reserved	
25	Gen Over Volt Warn	Action when gen over voltage warning, over voltage trip alarm occurs.
26	Gen Under Volt Warn	Action when gen under voltage warning, under voltage trip alarm occurs.
27	Dummy Load Control	No rated power setting and calculate percentage according to rated current. When loading current has fallen below the 20% of rated current, output port is active; has exceeded the 60% of rated current, output port is inactive.
28	Reserved	
29	Reserved	
30	Custom Period 1	Detailed function description please to see the following content.
31	Custom Period 2	
32	Custom Period 3	
33	Custom Period 4	
34	Custom Period 5	
35	Custom Period 6	
36	Custom Combined 1	
37	Custom Combined 2	
38	Custom Combined 3	
39	Custom Combined 4	
40	Custom Combined 5	
41	Custom Combined 6	
42	Reserved	
43	Reserved	
44	Reserved	
45	Reserved	
46	Reserved	
47	Reserved	
48	Reserved	
49	Cooler Control	It is controlled by cooler of temperature sensor's limited threshold.
50	Common Trip and Stop	Action when common trip and stop alarm occurs.
51	Common Trip Alarm	Action when common trips alarm occurs.
52	Common Warning Alarm	Action when common warning alarm occurs.
53	Reserved	
54	Battery Volt High	Action when battery's over voltage warning alarm occurs.
55	Battery Volt Low	Action when battery's low voltage warning alarm occurs.
56	Reserved	
57	Emergency Stop Alarm	Action when emergency stop alarm occurs.
58	Fail to Start Alarm	Action when failed start alarm occurs.
59	Fail to Stop Alarm	Action when failed stop alarm occurs.

No.	Item	Description
60	Under Speed Shutdown	Action when under speed shuts down occurs.
61	Over Speed Shutdown	Action when over speed shutdown alarm occurs.
62	Reserved	
63	Over Freq Warning Shutdown	Action when generator over frequency shutdown alarm occurs.
64	Gen Over Volt Shutdown	Action when generator over voltage shutdown occurs.
65	Gen Under Freq Shutdown	Action when generator low frequency shutdown occurs.
66	Under Volt. Shutdown	Action when generator low voltage shutdown occurs.
67	Reserved	
68	Over Power Alarm	Action when controller detects generator has over power.
69	Reserved	
70	Gen Reverse Power	Action when controller detects generator has reverse power.
71	Over Current Alarm	Action when over current occurs.
72	Reserved	
73	High Temp Warn	Action when high-temperature warning occurs.
74	High Temp Shutdown	Action when high-temperature shutdown alarm occurs.
75	Temp Sensor Open	Action when the temperature sensor is open circuit.
76	Reserved	
77	Low Oil Pressure Warn	Action when low oil pressure warning occurs.
78	Low Oil Pressure Shutdown	Action when low oil pressure shutdown occurs.
79	Oil Pressure Sensor Open Circuit	Action when the oil pressure sensor is open circuit.
80	Reserved	
81	Reserved	
82	Reserved	
83	Flexible Sensor 1 High Warn	Action when the flexible sensor 1 high warning occurs.
84	Flexible Sensor 1 Low Warn	Action when the flexible sensor 1 low warning occurs.
85	Flexible Sensor 1 High Shutdown	Action when the flexible sensor 1 high shutdown occurs.
86	Flexible Sensor 1 Low Shutdown	Action when the flexible sensor 1 low shutdown occurs.
87	Flexible Sensor 1 Open Circuit	Action when the flexible sensor 1 is open circuit.
88	Reserved	
89	In Stop Mode	Action when system is in stop mode.
90	In Manual Mode	Action when system is in Manual mode.
91	Reserved	
92	Reserved	
93	Aux Input 1 Active	Action when input port 1 is active



No.	Item	Description
94	Aux Input 2 Active	Action when input port 2 is active
95	Aux Input 3 Active	Action when input port 3 is active
96	Aux Input 4 Active	Action when input port 4 is active
97	Aux Input 5 Active	Action when input port 5 is active
98	Aux Input 6 Active	Action when input port 1 is active
99	Reserved	

## 7.2 USER-DEFINED PERIOD OUTPUT

Defined Period output is composed by 2 parts, **period output S1** and **condition output S2**.



While **S1** and **S2** are **TRUE** synchronously, **OUTPUT**;

While **S1** or **S2** is **FALSE**, **NOT OUTPUT**.

**Period output S1** can set generator's one or more period output freely, can set the delayed time and output time after entering period.

**Condition output S2** can set as any conditions in output ports.

**▲NOTE:** when delay time and output time both are 0 in period output S1, it is TRUE in this period.

Output period: start

Delay output time: 2s

Output time: 3s

Condition output contents: output port 1 is active

Close when condition output active/inactive: close when active (disconnect when inactive);

Output port 1 active, after enter "starts time" and delay 2s, this defined period output is outputting, after 3s, stop outputting;

Output port 1 inactive, defined output period is not outputting.

## 7.3 USER-DEFINED COMBINATION OUTPUT

Defined combination output is composed by 3 parts, OR condition output SW1, OR condition output SW2, AND condition output SW3.

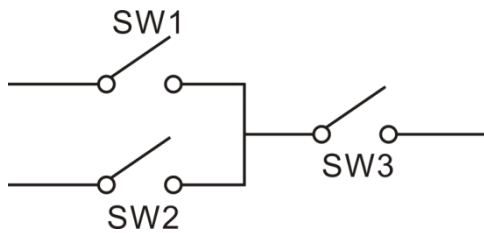

SW1 or SW2 is **TRUE**, while SW3 is **TRUE**, defined combination output is active;

SW1 and SW2 are **FALSE**, or SW3 is **FALSE**, defined combination output is deactivated.

**▲NOTE:** SW1, SW2, SW3 can be set as any contents except for “defined combination output” in the output setting.

**▲NOTE:** 3 parts of defined combination output (SW1, SW2, SW3) couldn't include or recursively include themselves.

Example,

Contents of OR condition output SW1: input port 1 is active;

Close when OR condition output SW1 is active/inactive: close when active (disconnect when inactive);

Contents of OR condition output SW2, input port 2 is active;

Close when OR condition output SW2 is active/inactive: close when active (disconnect when inactive);

Contents of AND condition output SW3: input port 3 is active;

Close when AND condition output SW3 is active/inactive: close when active (disconnect when inactive);

When input port 1 active or input port 2 active, if input port 3 is active, defined combination output is outputting; If input port 3 inactive, defined combination output is not outputting;

When input port 1 inactive and input port 2 inactive, whatever input port 3 is active or not, defined combination output is not outputting.

**Table 12 Defined Contents of Digit Input Port 1~5 (All active for GND (B~) connected)**

No.	Type	Description
0	User Configured	Including following functions, Indication: indicate only, not warning or shutdown. Warning: warn only, not shutdown. Shutdown: alarm and shutdown immediately Trip and stop: alarm, generator unloads and shuts down after hi-speed cooling Trip: alarm, generator unloads but not shutdown. Never: input inactive. Always: input is active all the time. From starting: detecting as soon as start. From safety on: detecting after safety on run delay.
1	High Temperature Warning	After safety on run delay, if this signals are active, genset will alarm and shutdown immediately.
2	Low Oil Pressure Warning	
3	External Warn Input	Only warning and not stop if this input is active.
4	External Shutdown Input	Genset will warn and shutdown immediately if the signal is active.
5	WTH STOP by Cool	When the gen-set is running normally and this signal is activated, if there is a water temperature high (WTH) situation, the controller will first cool down the generator and then stop it; if the signal is deactivated and a high temperature situation occurs, the controller will shut down the gen-set without cooling down.
6	Generator Closed Auxiliary	Connected to the auxiliary switch of the generator on load.
7	Reserved	
8	Inhibit WTH STOP	When it is active, prohibit stopping when water temperature high (WTH) situation occurs. Details to see <a href="#">NOTE 2</a>
9	Inhibit OPL STOP	When it is active, prohibit stopping when oil pressure low situation (OPL) occurs. Details to see <a href="#">NOTE 3</a>
10	Remote Start	When this input is active in auto mode, genset start automatically and on load after running. Otherwise, genset will stop automatically if it is deactivated.
11	Fuel Level Warning	Connected to digital input port of sensor, if this input is active, controller will send warn alarm signal. Connected to digital input port of sensor, if this input is active, controller will send shutdown alarm signal.
12	Low Coolant Level Warn	
13	Fuel Level Shutdown	
14	Coolant Level Shutdown	
15	Inhibit Start Auto	In Auto mode, if this input is active, genset will not start whether mains power is abnormal or not. If genset is normally running, stop command won't be executed. When this input is deactivated, genset will automatically start or stop according to mains status.
16	Reserved	
17	Charge Alt Failure Warning	Connected to charge alt failure output port.
18	Reserved	
19	Alarm Mute	When input is active, "Audible Alarm" output can be inhibited.
20	Idle Control Mode	Idle control output when input is active.

No.	Type	Description
21	60Hz Select	Used for genset with CANBUS interface. When it is active, frequency is 60Hz.
22	Raise Speed Pulse	It is used for GTSC1 electronic fuel injection engine, when it is active, engine speed will increase 50rpm.
23	Drop Speed Pulse	It is used for GTSC1 electronic fuel injection engine, when it is active, engine speed will decrease 50rpm.
24	Forced Manual Start	When it is active, genset will be forced started, details please to see Emergency Start.
25	War Mode	All shutdown alarms are prohibited except for the emergency stop.
26	Reserved	
27	Instrument Mode	All outputs are prohibited in this mode.
28	RS232 Display Control Enable	When it is active, main control function can be realized by the displayed HGM8140D module on RS232 port.
29	CAN-1 Display Control Enable	When it is active, main control function can be realized by the displayed HGM8140D module on CAN-1 port.
30	CAN-2 Display Control Enable	When it is active, main control function can be realized by the displayed HGM8140D module on CAN-2 port.
31	CAN-3 Display Control Enable	When it is active, main control function can be realized by the displayed HGM8140D module on CAN-3 port.
32	Simulate Manual Key	Can connect a button (not self-locking) externally to simulate panel keys.
33	Simulate Auto Key	
34	Simulate Stop Key	
35	Simulate Start Key	

**Table 13 Sensors Selection**

No	Item	Content	Remark
1	Temperature Sensor	0 Not used 1 Custom Resistor Curve 2 VDO 3 SGH 4 SGD 5 CURTIS 6 DATCON 7 VOLVO-EC 8 SGX 9 Reserved 10 Reserved 11 Digital Low Input Active 12 Digital High Input Active	Defined resistance's range is 0Ω-6000Ω, default is SGX sensor.
2	Pressure Sensor	0 Not used 1 Custom Resistor Curve 2 VDO 10Bar 3 SGH 4 SGD 5 CURTIS 6 DATCON 10Bar 7 VOLVO-EC 8 SGX 9 Reserved 10 Reserved 11 Digital Low Input Active 12 Digital High Input Active	Defined resistance's range is 0Ω-6000Ω, default is SGX sensor.
3	Fuel Level Sensor	0 Not used 1 Custom Resistor Curve 2 SGH 3 SGD 4 Reserved 5 Reserved 6 Digital Low Input Active 7 Digital High Input Active	Defined resistance's range is 0Ω-6000Ω, default is SGD sensor.

**Table 14 Crank Disconnect Conditions**

No.	Setting description
0	Speed
1	Gen frequency
2	Speed + Gen frequency
3	Speed +Oil pressure
4	Gen frequency + Oil pressure
5	Speed + Gen frequency + Oil pressure
6	Oil pressure

**▲NOTES:**

- 1) There are 3 conditions to make starter separate with engine; speed, generator frequency and oil pressure can be used separately while oil pressure suggest be used together with speed and generator frequency. The aim is to disconnect the starter motor as soon as possible.
- 2) Speed sensor is the magnetic equipment which be installed in starter for detecting flywheel teeth.
- 3) When set as speed, must ensure that the number of flywheel teeth is as same as setting, otherwise, "over speed shutdown" or "under speed shutdown" may be caused.
- 4) If genset without speed sensor please don't select corresponding items, otherwise, "start fail" or "loss speed signal" maybe caused.
- 5) If genset without oil pressure sensor, please don't select corresponding items.
- 6) If not select generator frequency in crank disconnect setting, controller will not collect and display the relative power quantity (can be used in water pump set); if not select speed in crank disconnect setting, the engine speed displayed in controller is calculated by generator signal.

## 8 PARAMETERS SETTING

Start the controller, then press  to enter the parameters setting menu, menu items as follows:

- 1 Set Parameters
- 2 Information
- 3 Language
- 4 Event Log
- 5 Display Module Type
- 6 Maintenance

### Parameters Setting

When entered password interface, inputting "0318" can set all parameter items in *Table 10*. If the password is changed, only input the password same as controllers', can the parameter be set via PC software. If there is need to set more parameters (e.g. voltage calibration; current calibration), please contact the factory.

#### **NOTES:**





- 1) Please change the controller parameters when generator is in standby mode only (e. g. Crank disconnect conditions selection, digital input setting, relay output setting, various delay), otherwise, shutdown and other abnormal conditions may occur.
- 2) Over voltage set value must be higher than under voltage set value, otherwise over voltage and under voltage condition may occur simultaneously.
- 3) Over speed set value must be higher than under speed set value, otherwise over speed and under speed condition may occur simultaneously.
- 4) Please set the generator frequency value as low as possible when cranking, in order to make the starter be separated quickly as soon as possible.
- 5) Digital input 1~6 could not be set as same items; otherwise, there are abnormal functions. However, the relay output 1~5 can be set as same items.
- 6) If need to shut down after cooling, please set any auxiliary input as "High Temperature Stop Input", then connect this input port to GND or set "High Temperature Stop Input" action as "Cooling Stop".

### Controller Information

- 1) LCD will display developing information like software version, issue date of the controller.

**NOTE:** In this interface, press  will display the digital inputs and outputs status.

- 2) Language selection  
Chinese, English and Spanish can be optional.
- 3) LCD contrast control

Press  and  or  and  simultaneously to adjust LCD contrast ratio and make LCD character display more clearly. Contrast ratio adjustment range: 0-7.

## 9 SENSOR SETTING

- 1) When sensors are reselected, the sensor curve will be transferred into the standard value. For example, if temperature sensor is SGH (120°C resistor type), its sensor curve is SGH (120°C resistor type); if select the SGD (120°C resistor type), the temperature sensor curve is SGD curve.
- 2) When there is difference between standard sensor curves and used sensor, users can select "custom sensors" and then input custom sensor curve.
- 3) When users input the sensor curve, X value (resistor) must be inputted from small to large, otherwise, mistake occurs.
- 4) When sensor is selected as "Not Used", LCD displays temperature, pressure and fuel level as "- -".
- 5) If there is not oil pressure sensor, but there is low oil pressure alarm switch, users must set the oil pressure sensor as "None", otherwise, maybe low oil pressure shutdown occurs.
- 6) The headmost or backmost values in the vertical coordinates can be set as same as below.

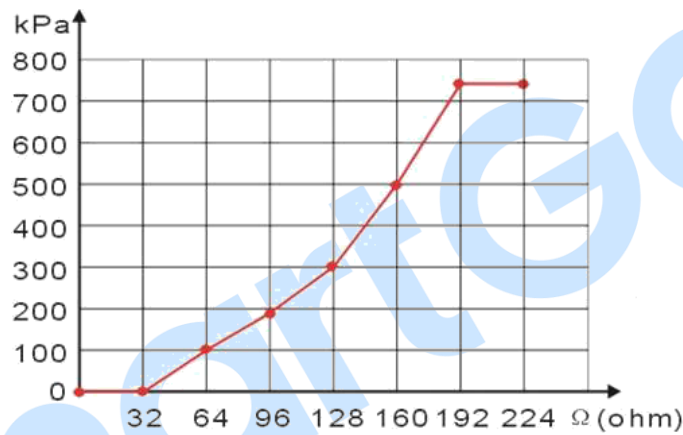

**Fig.6 Pressure Sensor Curve**

**Table 15 Common Unit Conversion**

	N/m <sup>2</sup> (Pa)	kgf/cm <sup>2</sup>	bar	psi
1Pa	1	1.02x10 <sup>-5</sup>	1x10 <sup>-5</sup>	1.45x10 <sup>-4</sup>
1kgf/cm <sup>2</sup>	9.8x10 <sup>4</sup>	1	0.98	14.2
1bar	1x10 <sup>5</sup>	1.0 <sup>2</sup>	1	14.5
1psi	6.89x10 <sup>3</sup>	7.03x10 <sup>-2</sup>	6.89x10 <sup>-2</sup>	1



## 10 COMMISSIONING

Please make sure the following checks are made before commissioning.

- 1) Ensure all the connections are correct and wires diameter is suitable.
- 2) Ensure that the controller DC power has fuse, controller's positive and negative connected to start battery are correct.
- 3) Emergency stop input is connected to the positive pole of starter battery via emergency stop button's normally closed point and fuse.
- 4) Take proper action to prevent engine to crank success (e. g. Remove the connection wire of fuel valve). If checking is OK, make the start battery power on; choose manual mode and controller will executive routine.
- 5) Set controller under manual mode, press "start" button, genset will start. After the cranking times as setting, controller will send signal of Start Failure; then press "stop" to reset controller.
- 6) Recover the action to prevent engine to crank success (e. g. Connect wire of fuel valve), press start button again, genset will start. If everything goes well, genset will normal running after idle running (if idle run be set). During this time, please watch for engine's running situations and AC generator's voltage and frequency. If abnormal, stop genset and check all wires connection according to this manual.
- 7) Choose "Auto Mode" from front panel and connect to mains signal, controller will transfer ATS (if enabled) to mains on load after "Mains Normal" delay. Genset will stop after cooling and standby for the mains fault again;
- 8) If mains fault again, genset will start automatically and enter into normal running status. And then initiate close gen command to control ATS transfers to genset on load. If not, please check ATS controlling wiring connection according to this user manual;
- 9) If there is any other question, please contact SmartGen's service.

11 TYPICAL APPLICATION

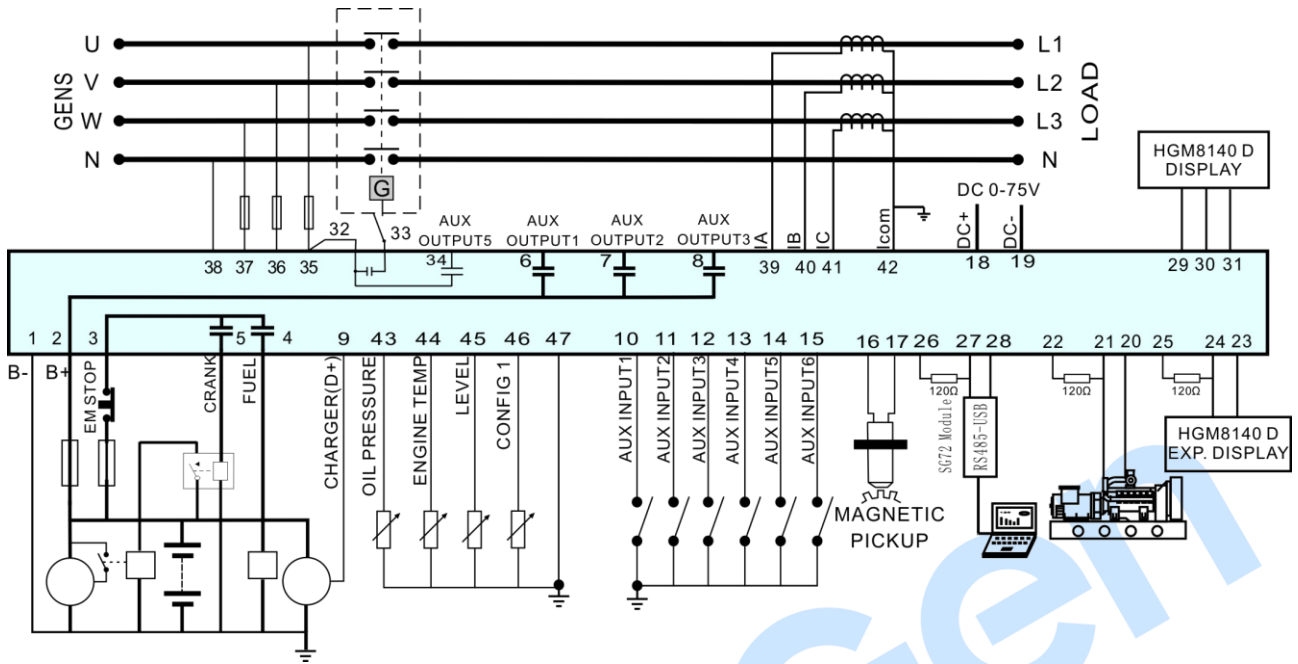

Fig.7 HGM8140M Typical Application

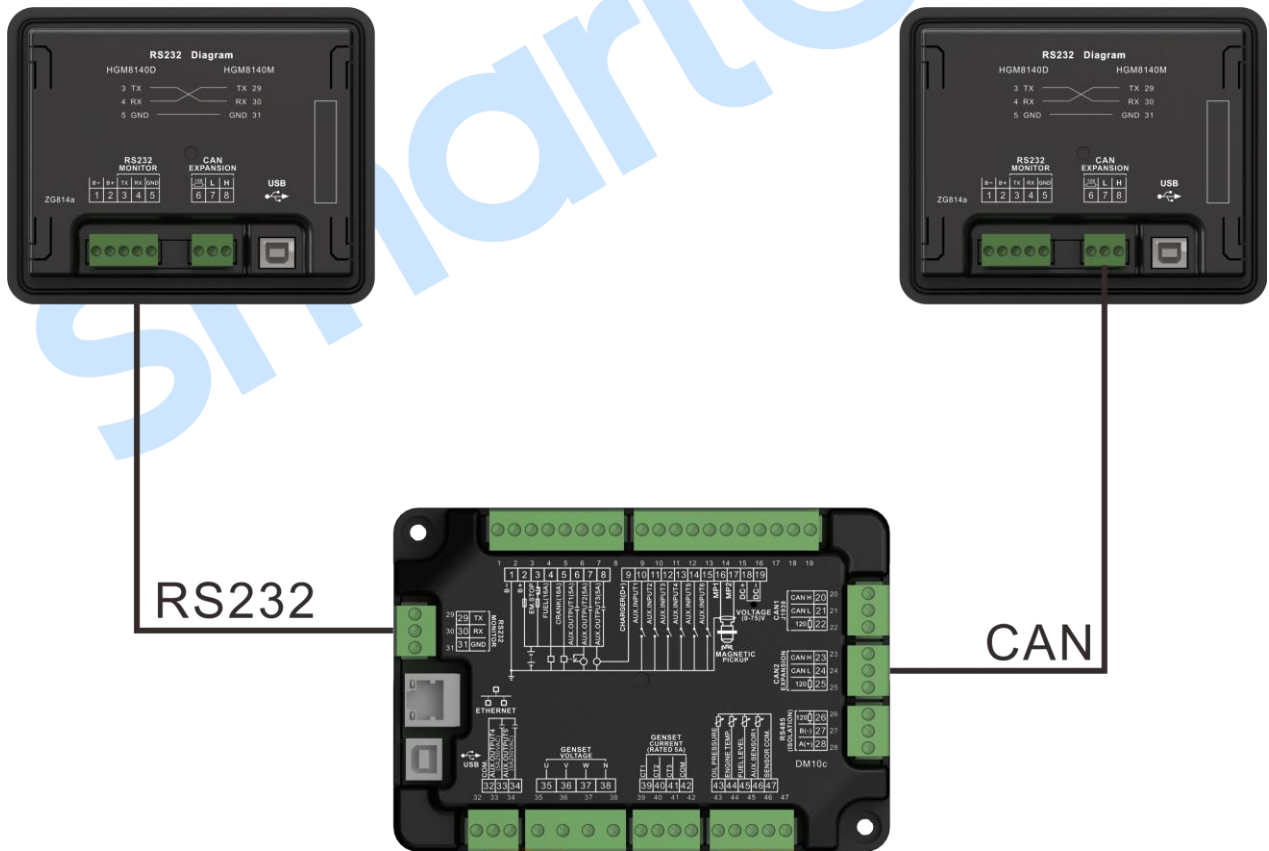

Fig.8 HGM8140 Connection Schematic Diagram

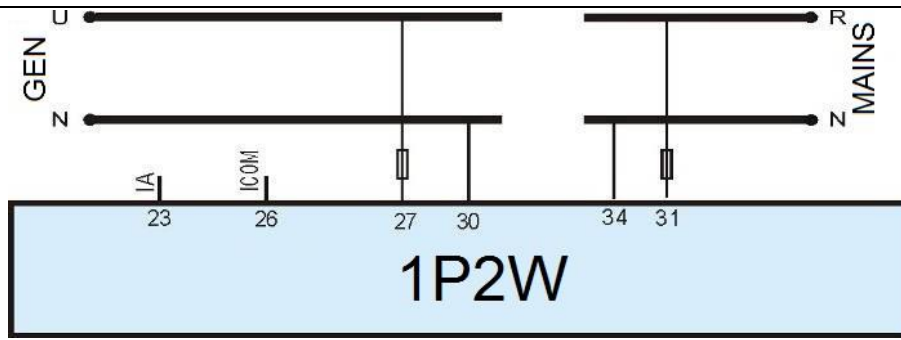

Fig.9 Single Phase 2-Wire Wiring Connection

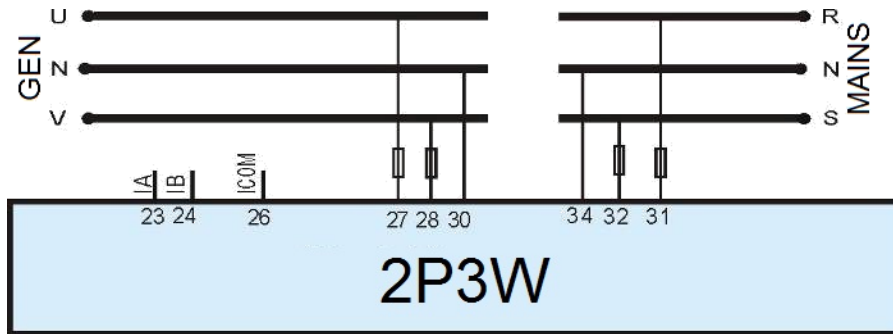

Fig.10 2-Phase 3-Wire Connection

**NOTE:** Expand relay with high capacity in start and fuel output is recommended.

12 INSTALLATION

12.1 FIXING CLIPS

- 1) Controller is panel built-in design; it is recommended that panel thickness should be  $\leq 4.5\text{mm}$ ; it is fixed by clips when installed.
- 2) Withdraw the fixing clip screw (turn anticlockwise) until it reaches proper position.
- 3) Pull the fixing clip backwards (towards the back of the module) ensuring four clips are inside their allotted slots.
- 4) Turn the fixing clip screws clockwise until they are fixed on the panel.

**▲NOTE:** Care should be taken not to over tighten the screws of fixing clips.

12.2 OVERALL DIMENSION

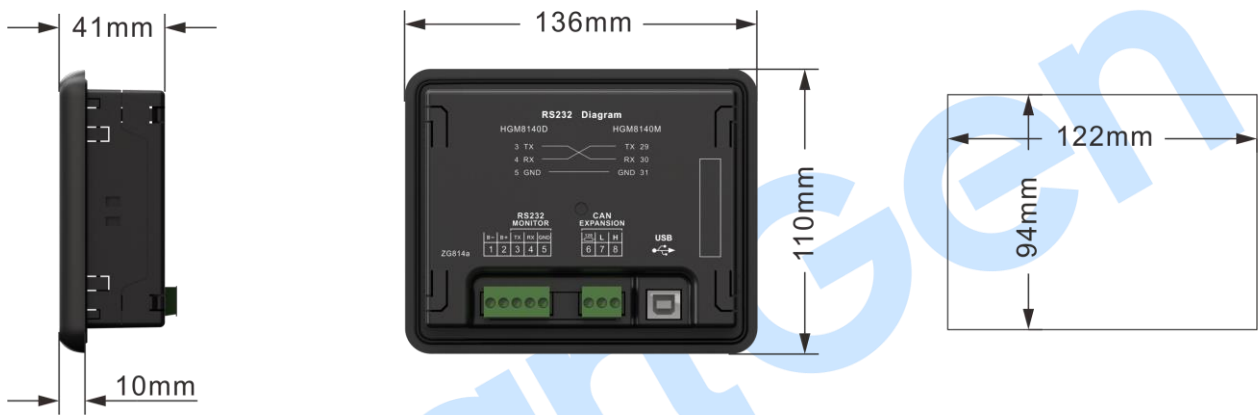
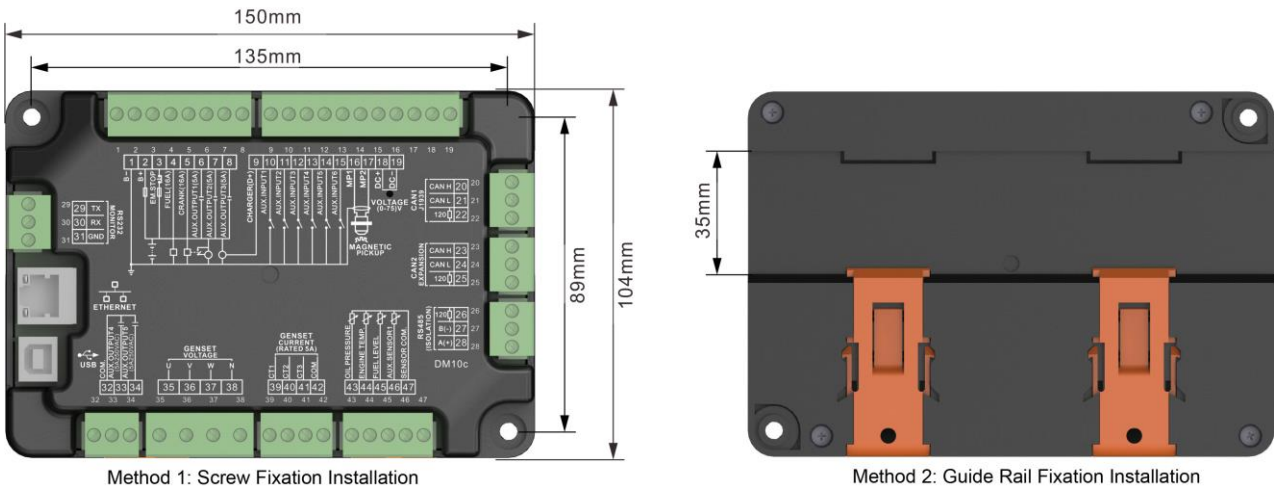

Fig.11 HGM8140D Overall and Cutout Dimensions



Method 1: Screw Fixation Installation

Method 2: Guide Rail Fixation Installation

Fig.12 HGM8140M Overall and Installation Dimensions

HGM8140 genset controller can suit for widely range of battery voltage (8~35) VDC. Negative of battery must be connected with the engine shell. Diameter of wire that connects from power supply to battery must be over  $2.5\text{mm}^2$ . If floating charge is configured, please firstly connect output wires of charger to battery's positive and negative directly, then, connect wires from battery's positive and negative to controller's positive and negative input ports in order to prevent charge disturbing the controller's normal working.

## 1) Speed Sensor Input

Speed sensor is the magnetic equipment which be installed in starter and for detecting teeth of flywheel. Its connection wires to controller should apply for 2 cores shielding line. The shielding layer should connect to No.16 terminal in controller while another side is hanging in air. The else two signal wires are connected to No.15 and No.16 terminals in controller. The output voltage of speed sensor should be within (1~24)VAC (effective value) during the full speed. 12VAC is recommended (in rated speed). When install the speed sensor, let the sensor is spun to contacting flywheel first, then, port out 1/3 lap, and lock the nuts of sensor at last.

## 2) Output and Expand Relays

All outputs of controller are relay contact output type. If need to expand the relays, please add freewheel diode to both ends of expand relay's coils (when coils of relay have DC current) or, increase resistance-capacitance return circuit (when coils of relay have AC current), in order to prevent disturbance to controller or others equipment.

## 3) AC Input

Current input of controller must be connected to outside current transformer. And the current transformer's secondary side current must be 5A. At the same time, the phases of current transformer and input voltage must be correct. Otherwise, the collected current and active power may be not correct.

**▲NOTE:** ICOM port must be connected to negative pole of battery.



**WARNING!** When there is load current, transformer's secondary side is prohibited to open circuit.

## 4) Withstand Voltage Test

When controller had been installed in control panel, if it needs to do the high voltage test, please disconnect controller's all terminal connections, so as to prevent high voltage entering controller and damaging it.

## 13 CONNECTIONS OF CONTROLLER WITH J1939 ENGINE

### 13.1 CUMMINS ISB/ISBE

**Table 16 Connector B**

Terminals of controller	Connector B	Remark
Aux. output1	39	Set aux. output 1 as "Fuel Output".
Start relay output	-	Connect with starter coil directly.
Aux. Output 2	Expand 30A relay, battery voltage of 01, 07, 12, 13 is supplied by relay.	ECU power Set aux. output 2 as "ECU power".

**Table 17 9 Pins Connector**

Terminals of controller	9 pins connector	Remark
CAN_SCR	SAE J1939 shield	CAN communication shielding line(connect with ECU terminal only).
CAN(H)	SAE J1939 signal	Impedance 120Ω connecting line is recommended.
CAN(L)	SAE J1939 return	Impedance 120Ω connecting line is recommended.

Engine type: Cummins ISB.

### 13.2 CUMMINS QSL9

Suitable for CM850 engine control module

**Table 18 50 Pins Connector**

Terminals of controller	50 pins connector	Remark
Aux. output 1	39	Set aux. output 1 as "Fuel Output".
Start relay output	-	Connect to starter coil directly.

**Table 19 9 Pins Connector**

Terminals of controller	9 pins connector	Remark
CAN_SCR	SAE J1939 shield-E	CAN communication shielding line(connect with ECU terminal only).
CAN(H)	SAE J1939 signal-C	Using impedance 120Ω connecting line.
CAN(L)	SAE J1939 return-D	Using impedance 120Ω connecting line.

Engine Type: Cummins-CM850.

## 13.3 CUMMINS QSM11 (IMPORT)

Suitable for CM570 engine control module, engine type: QSM11 G1, QSM11 G2.

**Table 20 C1 Connector**

Terminals of controller	C1 connector	Remark
Aux. output 1	5&8	Set aux. output 1 as "Fuel Output" and outside expand relay, when fuel output, making port 5 and port 8 of C1 be connected.
Start relay output	-	Connect to starter coil directly.

**Table 21 3 Pins Data Link Connector**

Terminals of controller	3 pins data link connector	Remark
CAN_SCR	C	CAN communication shielding line (connect with ECU terminal only).
CAN(H)	A	Using impedance 120Ω connecting line.
CAN(L)	B	Using impedance 120Ω connecting line.

Engine Type: Cummins ISB.

## 13.4 CUMMINS QSX15-CM570

Suitable for CM570 engine control module, engine type: QSX15.

**Table 22 50 Pins Connector**

Terminals of controller	50 pins connector	Remark
Aux. output 1	38	Oil spout switch; Set aux. output 1 as "Fuel Output".
Start relay output	-	Connect to starter coil directly.

**Table 23 9 Pins Connector**

Terminals of controller	9 pins connector	Remark
CAN_SCR	SAE J1939 shield-E	CAN communication shielding line (Connect with ECU terminal only).
CAN(H)	SAE J1939 signal-C	Using impedance 120Ω connecting line.
CAN(L)	SAE J1939 return-D	Using impedance 120Ω connecting line.

Engine Type: Cummins QSX15-CM570.

## 13.5 CUMMINS GCS-MODBUS

It is suitable for GCS engine control module. RS485-MODBUS used to read information of engine. Engine types are QSX15, QST30, QSK23/45/60/78 and so on.

**Table 24 D-SUB Connector 06**

Terminals of controller	D-SUB connector 06	Remark
Aux. output 1	5&8	Set aux. output 1 as "Fuel Output" and expand relay, when fuel outputs, making port 05 and 08 of the connector 06 be connected.
Start relay output	-	Connect to starter coil directly.

**Table 25 D-SUB Connector 06**

Terminals of controller	D-SUB connector 06	Remark
RS485 GND	20	CAN communication shielding line (connect with ECU terminal only).
RS485+	21	Using impedance 120Ω connecting line.
RS485-	18	Using impedance 120Ω connecting line.

Engine Type: Cummins QSK-MODBUS, Cummins QST-MODBUS, Cummins QSX-MODBUS.

## 13.6 CUMMINS QSM11

**Table 26 Engine OEM Connector**

Terminals of controller	OEM connector of engine	Remark
Aux. output 1	38	Set aux. output 1 as "Fuel Output".
Start relay output	-	Connect with starter coil directly.
CAN_SCR	-	CAN communication shielding line.
CAN(H)	46	Using impedance 120Ω connecting line.
CAN(L)	37	Using impedance 120Ω connecting line.

Engine Type: Common J1939.



## 13.7 CUMMINS QSZ13

**Table 27 Engine OEM Connector**

Terminals of controller	OEM connector of engine	Remark
Aux. output 1	45	
Start relay output	-	Connect to starter coil directly.
Aux. output 2	16&41	Setting to idle speed control, normally open output. Making 16 connect to 41 during high-speed running of controller via external expansion relay.
Aux. output 3	19&41	Setting to pulse raise speed control, normally open output. Making 19 connect with 41 for 0.1s during high-speed warming of controller via external expansion relay.
CAN_SCR	-	CAN communication shielding line.
CAN(H)	1	Using impedance 120Ω connecting line.
CAN(L)	21	Using impedance 120Ω connecting line.

Engine type: Common J1939.

## 13.8 DETROIT DIESEL DDEC III/IV

**Table 28 Engine CAN Connector**

Terminals of controller	CAN port of engine	Remark
Aux. output 1	Expand 30A relay, battery voltage of ECU is supplied by relay.	Set aux. output 1 as "Fuel Output".
Start relay output	-	Connect to starter coil directly.
CAN_SCR	-	CAN communication shielding line.
CAN(H)	CAN(H)	Using impedance 120Ω connecting line.
CAN(L)	CAN(L)	Using impedance 120Ω connecting line.

Engine type: Common J1939.

## 13.9 DEUTZ EMR2

**Table 29 F Connector**

Terminals of controller	F connector	Remark
Aux. output 1	Expand 30A relay, battery voltage of 14 is supplied by relay. Fuse is 16A.	Set aux. output 1 as "Fuel Output".
Start relay output	-	Connect to starter coil directly.
-	1	Connect to battery negative pole.
CAN_SCR	-	CAN communication shielding line.
CAN(H)	12	Using impedance 120Ω connecting line.
CAN(L)	13	Using impedance 120Ω connecting line.

Engine Type: Volvo EDC4.

## 13.10 JOHN DEERE

**Table 30 21 Pins Connector**

Terminals of controller	21 pins connector	Remark
Aux. output 1	G, J	Set aux. output 1 as "Fuel Output".
Start relay output	D	
CAN_SCR	-	CAN communication shielding line.
CAN(H)	V	Using impedance 120Ω connecting line.
CAN(L)	U	Using impedance 120Ω connecting line.

Engine type: John Deere.

## 13.11 MTU MDEC

Suitable for MTU engines, 2000 series, 4000series

**Table 31 X1 Connector**

Terminals of controller	X1 connector	Remark
Aux. output 1	BE1	Set aux. output 1 as "Fuel Output".
Start relay output	BE9	
CAN_SCR	E	CAN communication shielding line (connect with one terminal only).
CAN(H)	G	Using impedance 120Ω connecting line.
CAN(L)	F	Using impedance 120Ω connecting line.

Engine type: MTU-MDEC-303.

## 13.12 MTU ADEC (SMART MODULE)

It is suitable for MTU engine with ADEC (ECU8) and SMART module.

**Table 32 ADEC (X1 Port)**

Terminals of controller	ADEC (X1 port)	Remark
Aux. output 1	X1 10	Set aux. output 1 as "Fuel Output". X1 Terminal 9 connected to negative of battery.
Start relay output	X1 34	X1 Terminal 33 Connected to negative of battery.

**Table 33 SMART (X4 Port)**

Terminals of controller	SMART (X4 port)	Remark
CAN_SCR	X4 3	CAN communication shielding line.
CAN(H)	X4 1	Using impedance 120Ω connecting line.
CAN(L)	X4 2	Using impedance 120Ω connecting line.

Engine type: MTU-ADEC.

## 13.13 MTU ADEC (SAM MODULE)

It is suitable for MTU engine with ADEC (ECU7) and SAM module.

**Table 34 ADEC (X1 Port)**

Terminals of controller	ADEC (X1 port)	Remark
Aux. output 1	X1 43	Set aux. output 1 as "Fuel Output". X1 Terminal 28 Connected to negative of battery.
Start relay output	X1 37	X1 Terminal 22 Connected to negative of battery.

**Table 35 SAM (X23 Port)**

Terminals of controller	SAM (X23 port)	Remark
CAN_SCR	X23 3	CAN communication shielding line.
CAN(H)	X23 2	Using impedance 120Ω connecting line.
CAN(L)	X23 1	Using impedance 120Ω connecting line.

Engine type: Common J1939.

## 13.14 PERKINS

It is suitable for ADEM3/ ADEM4 engine control module. Engine type is 2306, 2506, 1106, and 2806.

**Table 36 Connector**

Terminals of controller	Connector	Remark
Aux. output 1	1,10,15,33,34	Set aux. output 1 as "Fuel Output".
Start relay output	-	Connect to starter coil directly.
CAN_SCR	-	CAN communication shielding line
CAN(H)	31	Using impedance 120Ω connecting line.
CAN(L)	32	Using impedance 120Ω connecting line.

Engine type: Perkins.

## 13.15 SCANIA

It is suitable for S6 engine control module. Engine type is DC9, DC12, and DC16.

**Table 37 B1 Connector**

Terminals of controller	B1 connector	Remark
Aux. output 1	3	Set aux. output 1 as "Fuel Output".
Start relay output	-	Connect to starter coil directly.
CAN_SCR	-	CAN communication shielding line.
CAN(H)	9	Using impedance 120Ω connecting line.
CAN(L)	10	Using impedance 120Ω connecting line.

Engine type: Scania.

## 13.16 VOLVO EDC3

Suitable engine control mode is TAD1240, TAD1241, and TAD1242.

**Table 38 "Stand alone" Connector**

Terminals of controller	"Stand alone" connector	Remark
Aux. output 1	H	Set aux. output 1 as "Fuel Output".
Start relay output	E	
Aux. output 2	P	ECU power; Set aux. output 2 as "ECU power".

**Table 39 "Data bus" Connector**

Terminals of controller	"Data bus" connector	Remark
CAN_SCR	-	CAN communication shielding line.
CAN(H)	1	Using impedance 120Ω connecting line.
CAN(L)	2	Using impedance 120Ω connecting line.

Engine type: Volvo.

**▲NOTE:** When this engine type is selected, preheating time should be set to at least 3 seconds.

## 13.17 VOLVO EDC4

Suitable engine types: TD520, TAD520 (optional), TD720, TAD720 (optional), TAD721, TAD722, and TAD732.

**Table 40 Connector**

Terminals of controller	Connector	Remark
Aux. output 1	Expanded 30A relay, and relay offers battery voltage for terminal14. Fuse is 16A.	Set aux. output 1 as "Fuel Output".
Start relay output	-	Connect to starter coil directly.
	1	Connected to negative of battery.
CAN GND	-	CAN communication shielding line.
CAN(H)	12	Using impedance 120Ω connecting line.
CAN(L)	13	Using impedance 120Ω connecting line.

Engine type: VolvoEDC4.

## 13.18 VOLVO-EMS2

Suitable Volvo Engine types: TAD734, TAD940, TAD941, TAD1640, TAD1641, and TAD1642.

**Table 41 Engine CAN Port**

Terminals of controller	Engine's CAN port	Remark
Aux. output 1	6	ECU stop; Set aux output 1 as "ECU stop".
Aux. output 2	5	ECU power; Set aux. utput 2 as "ECU power".
	3	Negative power.
	4	Positive power.
CAN GND	-	CAN communication shielding line.
CAN(H)	1(Hi)	Using impedance 120Ω connecting line.
CAN(L)	2(Lo)	Using impedance 120Ω connecting line.

Engine type: Volvo-EMS2.

**▲NOTE:** When this engine type is selected, preheating time should be set to at least 3 seconds.

## 13.19 YUCHAI

It is suitable for BOSCH common rail electronic-controlled engine.

**Table 42 Engine 42 Pin Port**

Terminals of controller	Engine 42 pins port	Remark
Aux. output 1	1.40	Set aux. output 1 as "Fuel Output". Connect to engine ignition lock.
Start relay output	-	Connect to starter coil directly.
CAN GND	-	CAN communication shielding line.
CAN(H)	1.35	Using impedance 120Ω connecting line.
CAN(L)	1.34	Using impedance 120Ω connecting line.

**Table 43 Engine 2 Pin Port**

Battery	Engine 2 pins port	Remark
Battery negative	1	Wire diameter 2.5mm <sup>2</sup> .
Battery positive	2	Wire diameter 2.5mm <sup>2</sup> .

Engine type: BOSCH.

## 13.20 WEICHAO

It is suitable for Weichai BOSCH common rail electronic-controlled engine.

**Table 44 Engine Port**

Terminals of controller	Engine port	Remark
Aux. output 1	1.40	Set aux. output 1 as "Fuel Output". Connect to engine ignition lock.
Start relay output	1.61	
CAN GND	-	CAN communication shielding line.
CAN(H)	1.35	Using impedance 120Ω connecting line.
CAN(L)	1.34	Using impedance 120Ω connecting line.

Engine type: GTSC1.

**▲NOTE:** If there is any question of connection between controller and ECU communication, please feel free to contact SmartGen's service.

**14 ETHERNET PORT**

ETHERNET port, used for controller monitoring, has two connection modes: network client mode and web server mode.

**▲NOTE:** After changing controller network parameters (e.g. IP address, sub network mask etc.) new settings will take effect only after the controller is restarted.

**14.1 NETWORK CLIENT MODE**

When the controller is used as network client, it can be monitored via network port using TCP ModBus protocol.

The procedure is the following:

- 1) Set IP address and sub network of the controller. The IP address must in the same network segment as the IP address of monitoring equipment (e.g. PC) e.g.: if monitoring equipment IP address is 192.168.0.16, controller IP can be 192.168.0.18, sub network mask 255.255.255.0.
- 2) Connect the controller. It can be connected to the monitoring equipment directly using network cable or via switchboard.
- 3) The communication between the controller and monitoring equipment is carried out using TCP ModBus protocol.

**▲NOTE:** In this connection mode controller parameters can be set. SmartGen provides testing software for this connection mode. Communication protocol can be obtained from the SmartGen service.

**14.2 CONTROLLER AND NETWORK CABLE CONNECTION**

**Table 45 Controller Network Port Description**

No.	Name	Description
1	TX+	Tranceive Data+
2	TX-	Tranceive Data-
3	RX+	Receive Data+
4	NC	Not connected
5	NC	Not connected
6	RX-	Receive Data-
7	NC	Not connected
8	NC	Not connected

- 1) Controller and PC are connected directly using a network cable and for this connection crossover cable must be used.

For this connection crossover cable must be used.

Crossover cable: EIA/TIA 568A standard on one end and EIA/TIA 568B on the other end.

**▲NOTE:** If PC network port has Auto MDI/MDIX function, parallel cable can also be used.

- 2) Controller and PC connection via switchboard (or router).

Parallel lines must be used.

Parallel cable: EIA/TIA 568A standard on both ends or EIA/TIA 568B standard on both ends.

**▲NOTE:** If switchboard (or router) network port has Auto MDI/MDIX function, crossover cable can also be used.

15 TROUBLESHOOTING

Table 46 Troubleshooting

Symptoms	Possible Solutions
Controller no response with power.	Check starting batteries; Check controller connection wirings; Check DC fuse.
Genset shutdown	Check the water/cylinder temperature is too high or not; Check the genset AC voltage; Check DC fuse.
Controller emergency stop	Check whether emergency stop button function is correct or not; Check whether positive pole of starter battery is connected to emergency stop input or not; Check whether wire connection is open circuit or not.
Low oil pressure alarm after crank disconnect	Check the oil pressure sensor and its connections.
High water temp. alarm after crank disconnect	Check the temperature sensor and its connections.
Shutdown alarm in running	Check related switch and its connections according to the information on LCD; Check programmable inputs.
Crank not disconnect	Check fuel oil circuit and its connections; Check starting batteries; Check speed sensor and its connections; Refer to engine manual.
Starter no response	Check starter connections; Check starting batteries.
Genset running while ATS not transfer	Check ATS; Check the connections between ATS and controllers.
RS485 communication abnormal	Check connections; Check setting of COM port is correct or not; Check RS485's connections of A and B is reverse connect or not; Check RS485 transfer model whether damage or not; Check communication port of PC whether damage. Put 120Ω between A and B of controller RS485 port is recommended.