



SmartGen
ideas for power

HLS300
POWER SHARE MODULE
USER MANUAL



SMARTGEN (ZHENGZHOU) TECHNOLOGY CO.,LTD.



Chinese trademark

SmartGen English trademark

SmartGen — make your generator *smart*

SmartGen Technology Co., Ltd.

No.28 Jinsuo Road

Zhengzhou

Henan Province

P. R. China

Tel: 0086-(0)371-67988888/67981888

0086-(0)371-67991553/67992951

0086-(0)371-67981000(overseas)

Fax: 0086-(0)371-67992952

Web: www.smartgen.com.cn

www.smartgen.cn

Email: sales@smartgen.cn

All rights reserved. No part of this publication may be reproduced in any material form (including photocopying or storing in any medium by electronic means or other) without the written permission of the copyright holder.

Applications for the copyright holder's written permission to reproduce any part of this publication should be addressed to SmartGen Technology at the address above.

Any reference to trademarked product names used within this publication is owned by their respective companies.



SmartGen Technology reserves the right to change the contents of this document without prior notice.

Table 1 - Software Version

Date	Version	Content
2015-05-21	1.0	Original release.
2015-09-07	1.1	Modify terminal 1, terminal2 description.
2017-03-09	1.2	Add "Power Regulation Limit" description in parameter setting item; modified default values of Rated Voltage, Load Ramp Rate and etc.
2018-08-21	1.3	"Widely power supply range DC(8~35)V, suitable to different starting battery voltage environment" changed as "Widely power supply range DC(8~35)V" in section 2.
2019-05-16	1.4	Changed lamp description and typical application diagram.
2019-11-26	2.0	1. Changed LOW-P, P<20, UNLOADING three output ports to programmable output ports; 2. Added unbalance distribution of active power, P<20%, P>80% threshold and delay settings; 3. Added potentiometer enable, unload input pulse enable, load share optimization enable, speed regulator gain, unload failure and

Date	Version	Content
		<p>open enable, unload failure delay;</p> <p>4. Added parameters of mutual exclusion about potentiometer: min. pulse Tn of speed adjusting, cycle multiplier Tp of speed regulating, active power range Xp of speed adjusting, frequency range Xf of speed, active dead area Δf of speed; when potentiometer is not enabled, the parameters take effects;</p> <p>5. Added Fault Findings part.</p>

Table 2 – Symbolic Description

Sign	Instruction
 NOTE	Highlights an essential element of a procedure to ensure correctness.
 CAUTION!	Indicates a procedure or practice, which, if not strictly observed, could result in damage or destruction of equipment.

SmartGen



CONTENT

1	OVERVIEW.....	5
2	PERFORMANCE AND CHARACTERISTICS.....	5
3	SPECIFICATION.....	5
4	PANEL INDICATORS AND TERMINALS DESCRIPTION.....	6
5	SCOPES AND DEFINITIONS OF PROGRAMMABLE PARAMETERS.....	10
6	OUTPUT CONFIGURATION CONTENTS.....	13
7	FUNCTION DESCRIPTION.....	14
7.1	INSTRUCTION.....	14
7.2	FIXED POWER MODE.....	14
7.3	POWER SHARE MODE.....	14
7.4	TEST MODE.....	14
8	TYPICAL DIAGRAM.....	15
9	CASE DIMENSION.....	16
10	INSTALLATION PRECAUTIONS.....	17
10.1	OUTPUT AND EXPAND RELAYS.....	17
10.2	AC INPUT.....	17
10.3	WITHSTAND VOLTAGE TEST.....	17
11	FAULT FINDING.....	17

1 OVERVIEW

HLS300 Power Share Module is a special design for genset power share. On the basis of the set parameters, the module conducts automatically power share in genset running process.

The main function of HLS300 module is to share active load to each operating genset according to genset capacitance. The module is brief to operate, easy to install and widely used for ship genset and land genset.

2 PERFORMANCE AND CHARACTERISTICS

Main characters are as below:

- Suitable for 3-phase 3-wire, single phase 2-wire systems with frequency 50/60Hz;
- Adjustable potentiometer allows for setting main parameters of power share.
- Module parameters can be set via upper computer test software. LINK port should be connected to upper computer via SG72 module (USB to LINK)
- 8 relay outputs, 2 of which are used for controlling INCR. speed raise, and DECR. reduce, 5 are used for -P, UNLOADING, P>80%, P<20%, LOW-P output, and 1 is used for C/B OPEN;
- 1 FIXLOAD mode, 1 UNL, 1 close and 1 60Hz optional digital input;
- One test button for testing relay output and panel indicators;
- Wide power supply range DC(8~35)V;
- 35mm guide rail mounting;
- Modular design, pluggable terminal, compact structure with easy installation.

3 SPECIFICATION

Table 3 – Product Parameters

Parameter	Details
Working Voltage	DC8.0V to 35.0V continuous
Overall Consumption	≤2W(Standby mode≤0.5W)
AC Input	AC50V~ AC620 V (ph-ph)
AC Frequency	50Hz/60Hz
Relay Output	7A AC250V Volt free output
Case Dimensions	161.6mm x 89.7mm x 60.7mm
CT Secondary Current	Rated: 5A
Working Conditions	Temperature: (-25~+70)°C Humidity: (20~95)%
Storage Conditions	Temperature: (-25~+70)°C
Insulation Intensity	Apply AC2.2kV voltage between high voltage terminal and low voltage terminal; The leakage current is not more than 3mA within 1min.
Weight	0.45kg

4 PANEL INDICATORS AND TERMINALS DESCRIPTION

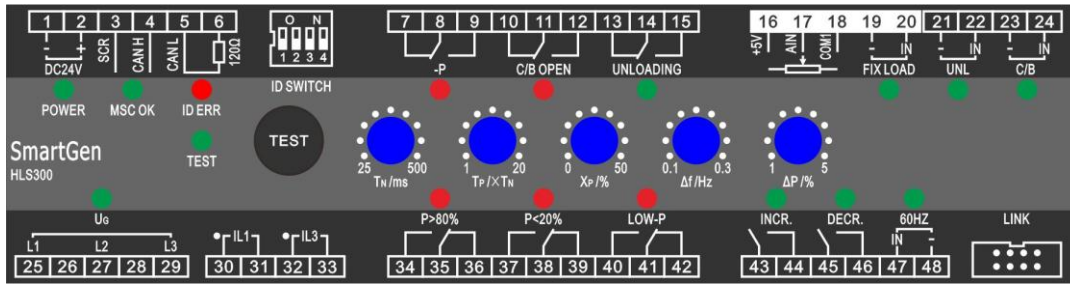

Fig.1 - Mask Drawing

Table 4 - LEDs Definition Description

Indicator	Color	Description	Note
Power	Green	Power indicator, the lamp illuminates when the power is normal.	
MSC OK	Green	MSC communication normal indicator, and it shall flash once for each data received.	
ID ERR	Red	MSCID setting error indicator, and the lamp illuminates when two module IDs are the same.	
TEST	Green	Indicates test mode.	
-P	Red	When reverse power reaches the set value and delay is expired, the relay output lamp will illuminate.	
C/B OPEN	Red	When the open relay is outputting, the lamp will illuminate.	
UNLOADING	Green	When the load is unloading, relay output lamp will illuminate.	Correspond to output function
FIXLOAD	Green	Fixed load mode indicator, the lamp will illuminate when input is active.	
UNL	Green	When Unload is active, the lamp will illuminate.	
C/B	Green	When the main switch close is active, the lamp will illuminate.	
UG	Green	When gens is normal, the lamp will illuminate; when gens is abnormal, the lamp will flash; when there is not power, the lamp will extinguish.	
P<20%	Red	When the load power is less than 20% (or set value) of Pn, the lamp will illuminate.	Correspond to output function
P>80%	Red	When the load power is over 80% (or set value) of Pn, the lamp will illuminate.	
LOW-P	Red	When the load is below the set value and delay is over, the lamp will illuminate.	Correspond to output function
INCR.	Green	When the raising speed pulse is sent, the lamp will illuminate.	
DECR.	Green	When the decreasing speed pulse is sent, the lamp will illuminate.	
60HZ	Green	When the two stitches– and IN are short circuit, while the rated frequency is 60Hz, the lamp will illuminate.	50/60HZ to choose



Table 5 - Potentiometer Description

Potentiometer	Range	Description	Note
TN/ms control pulse length	(25-500)ms	Control min. lasting time of pulse.	
TP/xTN	(1-20)TN	Adjustable speed pulse period=TPxTN	
Xp/% proportion range	(0-±50)%Pn (0-±2.5)Hz	In this area, pulse width and deviation value between Pn and rated frequency are in direct proportion.	Pn is rated power
△f/Hz	(0.1-0.3)Hz	Frequency precision adjustment; the frequency won't be adjusted in setting area.	
△P/%	(1-5)% of Pn	Power precision adjustment; the power won't be adjusted in setting area.	

Table 6 - Terminal Description

No.	Function		Cable	Note	
1	B-		1.0mm ²	Connected with negative of starter battery.	
2	B+		1.0mm ²	Connected with positive of starter battery.	
3	SCR		0.5mm ²	MSC communication.	
4	CANH		0.5mm ²		
5	CANL		0.5mm ²		
6	Terminal Resistor Match			If the terminal resistance match is needed, it needs to be short circuited to the terminal 5 or hang in the air.	
7	Reverse Power Output	Normally Close	2.5mm ²	Output when reverse power has exceeded set value and the delay is over.	Normally open, N/C contactor; Volt free output; 7A Rated
8		COM			
9		Normally Open			
10	Open Output	Normally Close	2.5mm ²	Output when open.	Normally open, N/C contactor; Volts free output; 7A Rated
11		COM			
12		Normally Open			
13	Load Transfer Indicator Output	Normally Close	2.5mm ²	Output when load transfers. Can be configured to other function output;	Normally open, N/C contactor; Volts free output; 7A Rated
14		COM			
15		Normally Open			
16	+5V		1.0mm	Power adjustment.	
17	AIN		1.0mm		
18	COM1		1.0mm		
19	FIXLOAD	-	1.0mm ²	Fixed power input, active when it is short circuit.	
20		IN			
21	UNL		1.0mm ²	Unload input, active when it is short circuit.	



No.	Function		Cable	Note	
22		IN			
23	C/B	-	1.0mm ²	Main switch close input, active when it is short circuit.	
24		IN			
25	L1		1.0mm ²	AC input.	
26					
27	L2		1.0mm ²		
28					
29	L3		1.0mm ²		
30	S1	CT A Phase Input	2.5mm ²	Externally connected to secondary coil of current transformer (rated 5A).	
31	S2				
32	S1	CT C Phase Input	2.5mm ²	Externally connected to secondary coil of current transformer (rated 5A).	
33	S2				
34	P>80% Output	Normally Open	2.5mm ²	Output when P>80% Pn (can set to other value) and delay is over.	Normally open, N/C contactor; Volts free output; 7A Rated
35		COM			
36		Normally Close			
37	P<20% Output	Normally Open	2.5mm ²	Output when P<20% Pn (can set to other value) and delay is over.	Normally open, N/C contactor; Volts free output; 7A Rated
38		COM			
39		Normally Close			
40	Low Power Output	Normally Open	2.5mm ²	Output when P<10%Pn (can be set to other value) and delay is over. Can be configured to other function output.	Normally open, N/C contactor; Volts free output; 7A Rated
41		COM			
42		Normally Close			
43	INCR.		2.5mm ²	Raise speed.	Normally open, Volt free, 7A Rated.
44					
45	DECR.		2.5mm ²	Reduce speed.	Normally open, Volt free, 7A Rated.
46					
47	Hz Selection	-	1.0mm ²	50/60Hz to choose	Short circuit is 60Hz
48		IN			
LINK	Used for parameter setting or software upgrade.				

NOTE: LOW-P, P<20, UNLOADING three outputs are programmable output ports, and can be defined to other functions; the indicators of output ports change with the changing of output functions.



Fig. 2 - PC Programming Connection Type

NOTE: About PC program connection, please connect SG72 module Link port with LINK port of this module. Through the PC software of our company, parameters can be set. Please see Fig. 2.

SmartGen

5 SCOPES AND DEFINITIONS OF PROGRAMMABLE PARAMETERS

Table 7 – Module Configurable Parameters

No.	Items	Parameters	Defaults	Description
1	AC System	(0-1)	0	0: 3P3W, 1: 1P2W
2	Rated Voltage	(30-30000) V	400	
3	Volt Trans.	(0-1)	0	0: Disabled 1: Enabled
4	Volt Trans. Primary Voltage	(30-30000)V	100	
5	Volt Trans. Secondary Voltage	(30-1000)V	100	
6	Over Volt	(0-1)	1	0: Disabled 1: Enabled
7		(100-120) %	115	Threshold
8		(100-120) %	113	Returned
9		(0-3600) s	3	Delay
10	Under Volt	(0-1)	1	0: Disabled 1: Enabled
11		(70-100) %	75	Threshold
12		(70-100) %	77	Returned
13		(0-3600) s	3	Delay
14	Over Freq	(0-1)	1	0: Disabled 1: Enabled
15		(100-120) %	110	Threshold
16		(100-120) %	104	Returned
17		(0-3600) s	3	Delay
18	Under Freq	(0-1)	1	0: Disabled 1: Enabled
19		(80-100) %	90	Threshold
20		(80-100) %	96	Returned
21		(0-3600) s	3	Delay
22	Loss Of Phase	(0-1)	1	0: Disabled 1: Enabled
23	Phase Rotation Monitor	(0-1)	1	0: Disabled 1: Enabled
24	CT Ratio/5	(5-6000)	500	
25	Full Load Rated Current	(5-6000)A	500	
26	Rated Power	(0-6000)kW	500	
27	Reverse Power Threshold	(0-20)%	10	
28	Reverse Power Delay	(1-20)s	3	
29	Low Power Threshold	(0-20)%	10	
30	Low Power Delay	(1-20)s	3	
31	20% Power Threshold	(0-50)%	20	Power< the value, terminal 21, 22 (relay P<20%) outputs;
32	20% Power Delay	(1-20)s	3	
33	80% Power Threshold	(0-120)%	80	Power> the value, terminal 19, 20 (relay P>80%) outputs;
34	80% Power Delay	(1-20)s	3	
35	Unbalance Threshold of Active Share	(0-50)%	20	
36	Unbalance Delay of Active Share	(1-20)s	3	



No.	Items	Parameters	Defaults	Description
37	LOW-P Output Type	(0-1)	0	0: N/O output 1: N/C output
38	LOW-P Output Contents	(0-30)	16	Default: LOW-P output Please refer to <i>Output Port Contents</i> .
39	P<20% Output Type	(0-1)	0	0: N/O output 1: N/C output
40	P<20% Output Contents	(0-30)	15	Default: P<20% output Please refer to <i>Output Port Contents</i> .
41	UNLOADING Output Type	(0-1)	0	0: N/O output 1: N/C output
42	UNLOADING Output Contents	(0-30)	12	Default: UNLOADING output; Please refer to <i>Output Port Contents</i> .
43	Address	(1-254)	1	
44	Load Ramp Rate	(0-100)%	2	
45	Load Ramp Rate Delay Percentage	(1-40)%	15	
46	Load Ramp Rate Delay	(0-30)s	5	
47	Load Parallel Ramp Minimum	(0-100)%	5	Load value of unload and breaker open;
48	Load Feedback Percentage	(0-100)%	50	Percentage of frequency dividing speed output;
49	Open Pulse Output	(1-1000)s	3	
50	Average Beat Freq	(0-1)	1	0: Disabled 1: Enabled
51	Power Regulation Limit	(0-50)%	30	When the max. output duty ratio of raise/drop speed relay is 0, the relay does not output.
52	Unload Input Pulse Enable	(0-1)	1	There is no need to issue signal continuously during the unload process if this is enabled.
53	Load Share Optimization Enable	(0-1)	1	Adjust to optimize in dead area margin; suitable for high flexibility occasions for governor.
54	Speed Regulating Gain	(0-1000)	100	Adjust the proportion gain of governor gain.
55	Failed to Unload and Open Enable	(0-1)	1	0: Disable 1: Enable
56	Failed to Unload Delay	(0-3600)s	30	During the delay, if unload is not up to the target, unload failure alarm occurs; if breaker open enable is set, then it will open.
57	Potentiometer Enable	(0-1)	1	0: Disable 1: Enable
58	Speed Governor Tn	(25-500)ms	100	The min. lasting time of speed control pulse;
59	Speed Governor Tp	(1-200)	20	Speed pulse period= $T_p \times T_N$;
60	Speed Governor Xp	(0-±50)%	50	During the area pulse width is in direct ratio with current active power and rated active power deviation



No.	Items	Parameters	Defaults	Description
				value;
61	Speed Governor Xf	$(0 \pm 2.5)\text{Hz}$	2.5	During the area pulse width is in direct ratio with current frequency and rated frequency deviation value;
62	$\Delta f/\text{Hz}$	$(0.1-0.3)\text{Hz}$	0.2	Frequency modulation accuracy; it won't adjust the frequency if frequency has exceeded the set area.
63	$\Delta P/\%$	$(1-15)\%$	5	Active power adjusting accuracy; it won't adjust the active power if this has exceeded the set area.

NOTE: ID can be set via dial-up switch of terminal side; the IDs of modules which are connected to the same CAN bus cannot be the same.

NOTE: The potentiometer on the module panel and configurations are exclusive; if potentiometer is enabled, then speed governor parameters are adjusted according to the potentiometer on the panel; Otherwise they will be adjusted according to configurations, and panel potentiometer will be ineffective.

SmartGen

6 OUTPUT CONFIGURATION CONTENTS

Table 8 – Output Port Contents

No.	Output Contents	Description
00	Not Used	
01	Over Voltage	
02	Under Voltage	
03	Over Frequency	
04	Under Frequency	
05	Reverse Power	
06	Reverse Phase Sequence	
07	Loss of Phase	
08	Reserved	
09	Unbalance of Active Power Share	
10	Reserved	
11	Breaker Open Output	
12	UNLOADING Output	
13	Common Alarm Output	
14	P>80% Output	
15	P<20% Output	
16	LOW-P Output	
17	MSC ID Wrong	
18	Speed Raise Output	
19	Speed Drop Output	
20	Reserved	
21	Reserved	
22	Failed to Unload	
23	Reserved	
24	Reserved	
25	Reserved	
26	Reserved	
27	Reserved	
28	Reserved	
29	Reserved	
30	Reserved	

7 FUNCTION DESCRIPTION

7.1 INSTRUCTION

The function of HLS300 Power Share Module is to proportionally share active load to each operating genset according to genset capacitance. When “FIXLOAD” is active, the module works in fixed power mode; otherwise the module works in power share mode. Press  button for 3s, and it will enter into test mode, which is used to test relay output and indicator status.



7.2 FIXED POWER MODE

Target power can be set via the external device connected with terminal 16, 17, 18. When close input is active, the module will adjust present power to target power and stabilize it between Δf and ΔP .

7.3 POWER SHARE MODE

Multiple modules are connected with each other via CAN bus and operate in power share mode together. Target power is an average of present power sums of these modules. When close input is active, the module will adjust present power to target power and stabilize it between Δf and ΔP .

7.4 TEST MODE

Press  button for 3s, and the module will enter into test mode and the lamp will illuminate, in the mean time the other lamps irrelevant with relay output will illuminate. -P relay outputs and the corresponding lamp will illuminate. In this mode, for every time to press  button, there will be a relay output and the corresponding lamp will illuminate. The module will quit test mode after relay output is finished (every time there will be only one relay output and the corresponding lamp will illuminate). When it is in test mode, the module will automatically quit if there is no button pressed for about 18s.

▲NOTE: Test mode is prohibited when the module is operating (when close input is active).

8 TYPICAL DIAGRAM

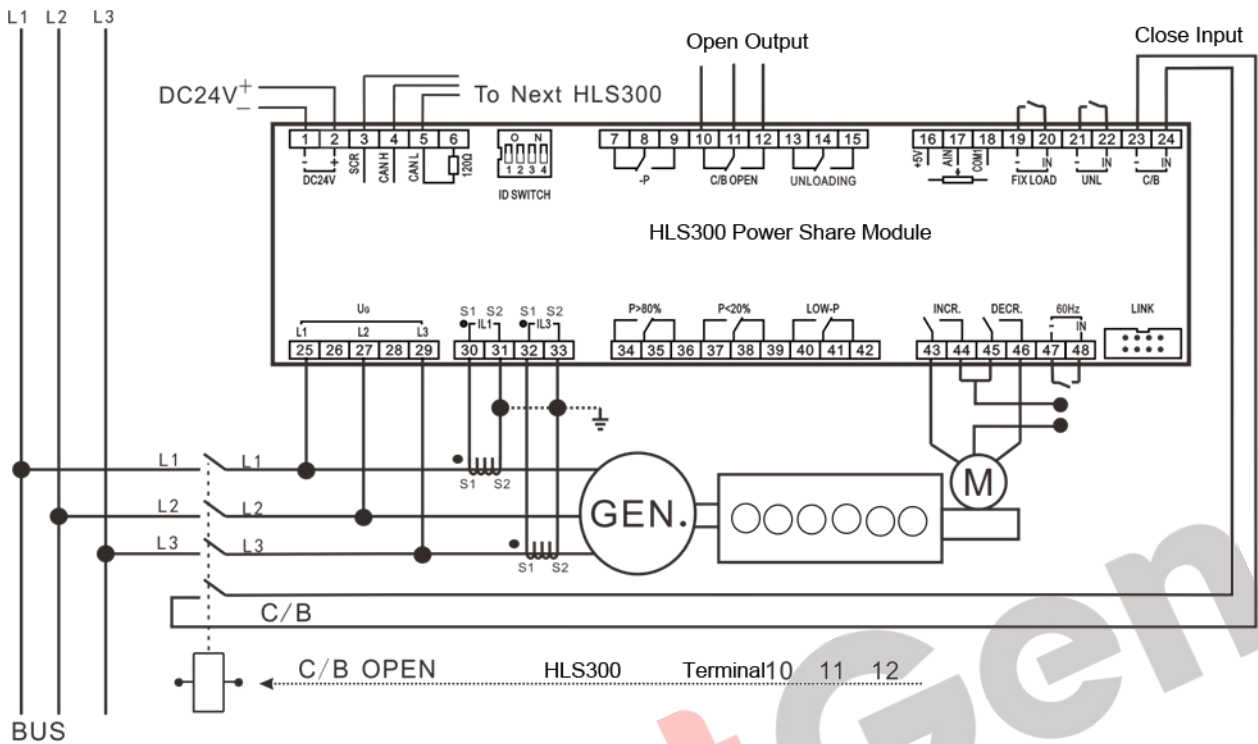

Fig.3 - HLS300 3Phase 3Wire Typical Application

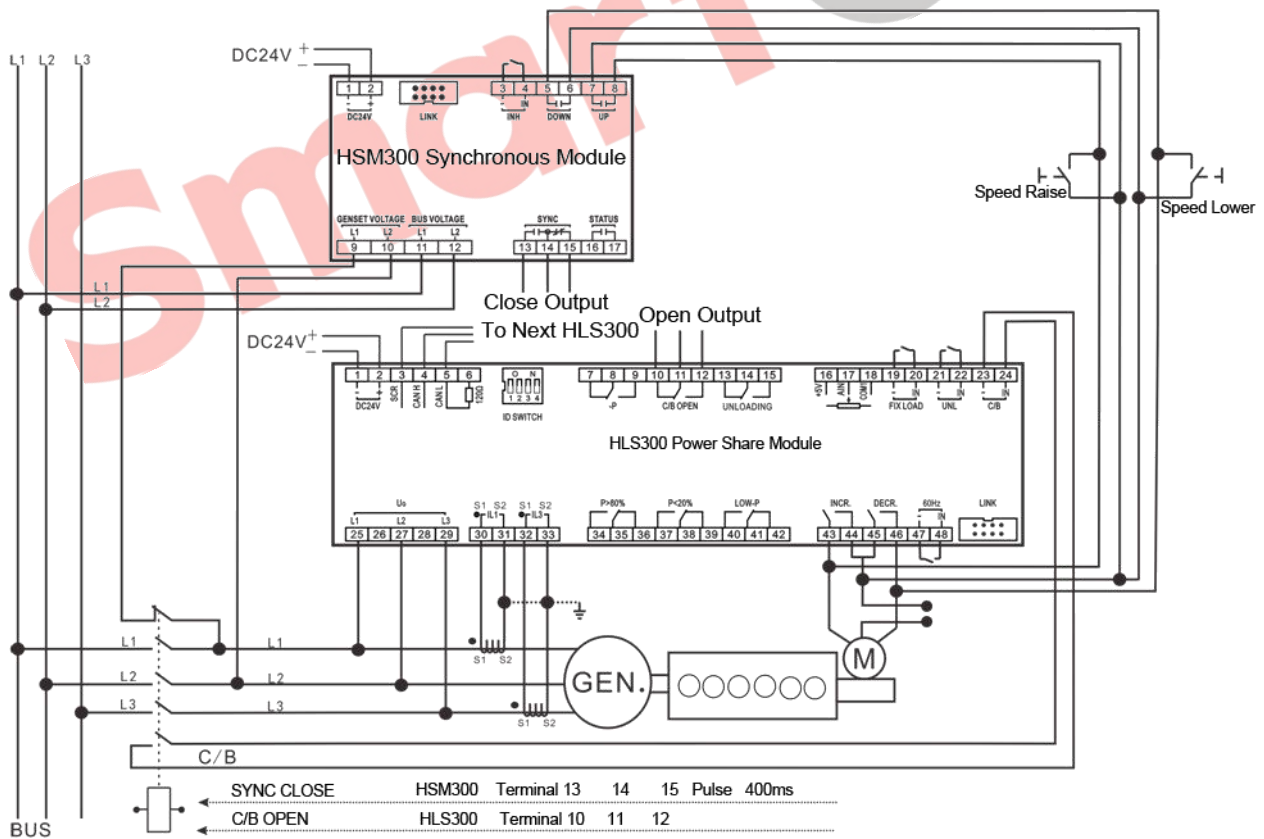

Fig.4 - HSM300-HLS300 3Phase 3Wire Typical Application

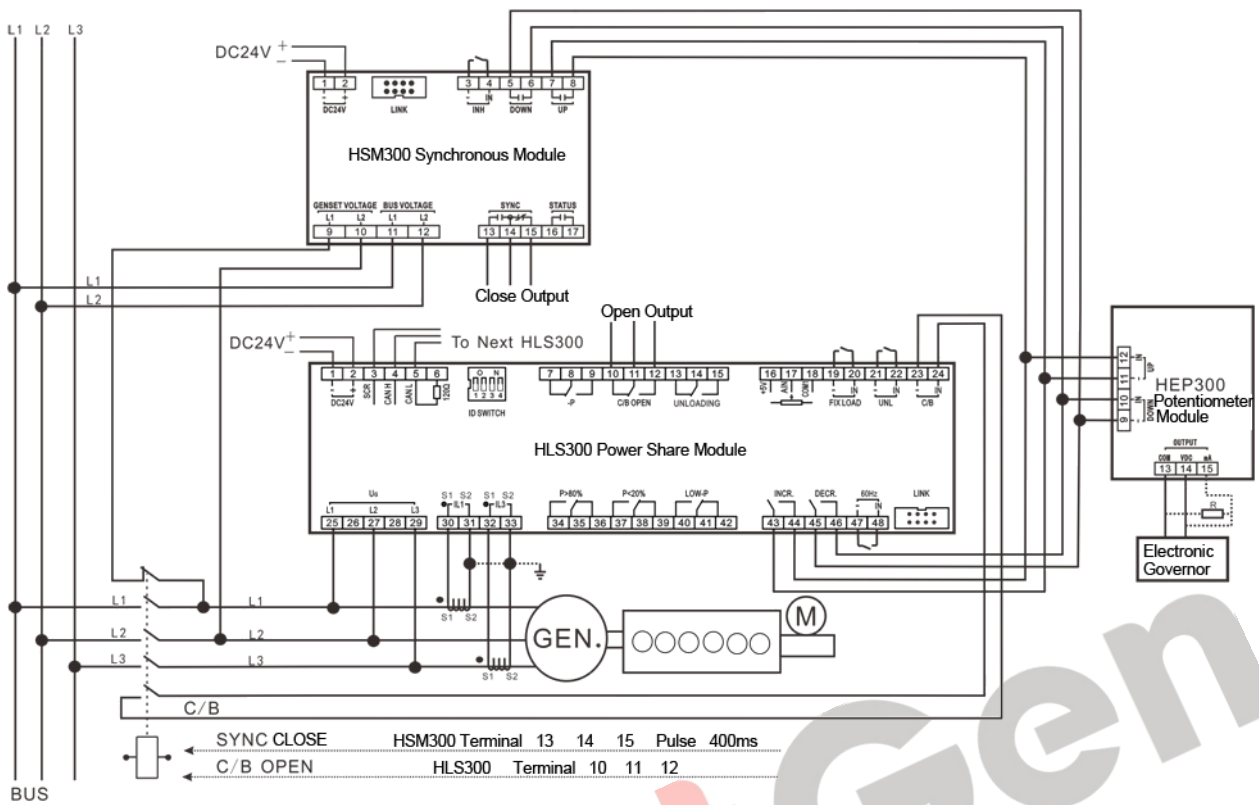

Fig.5 - HSM300-HLS300-HEP300 3Phase 3Wire Typical Application

9 CASE DIMENSION

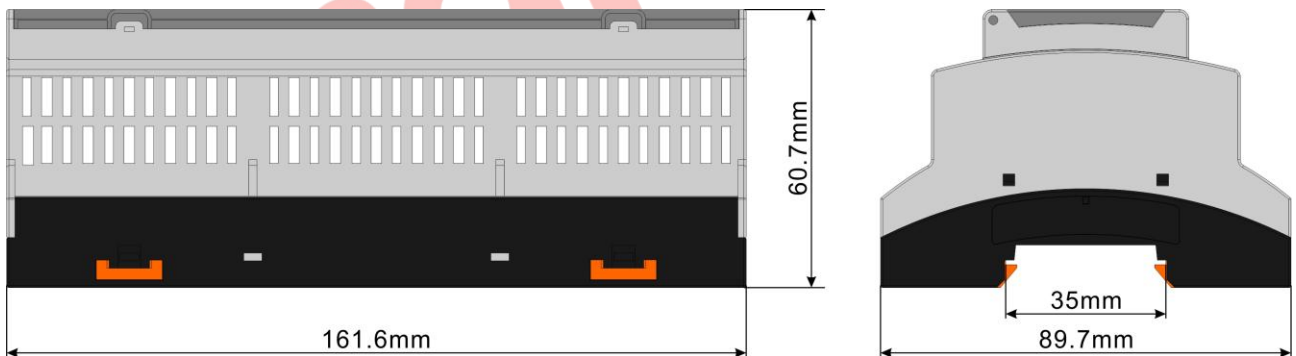

Fig.6 – Overall Dimensions

10 INSTALLATION PRECAUTIONS

10.1 OUTPUT AND EXPAND RELAYS

All outputs are relay contact output type. If it needs to expand the relays, please add freewheel diode to both ends of expand relay's coils (when coils of relay have DC current) or, add resistance-capacitance return circuit (when coils of relay have AC current), in order to prevent disturbance for controller or other equipments.

10.2 AC INPUT

Current input must be connected to outside current transformer. And the current transformer's secondary side current must be 5A. Meanwhile the phases of CT and input voltage must be correct, otherwise the sampling current and active power may be incorrect.

▲ NOTE: When there is load current, transformer's secondary side is prohibited to have open circuit.

10.3 WITHSTAND VOLTAGE TEST

▲ CAUTION! When relay had been installed in control panel, if need the high voltage test, please disconnect relay's all terminal connections, in order to prevent high voltage into relay and damage it.

11 FAULT FINDING

The followings are the common faults and troubleshooting methods during the use process of our company controllers. If other unsolvable faults occur, please contact our company.

Table 9 - Fault Findings

Fault Symptom	Possible Measures
Controller no response with power on	Check controller connection wirings; Check power fuse;
Unbalanced power share	Check governor wirings; Check whether breaker close feedback input is normal or not;
Circular high and low distribution of gensets in parallel network; (Leisurely car)	Dead area of power distribution setting is too minimum; Speed governor parameter configurations make output flexibility too high; Speed governor flexibility is too high.
No response for unloading	Check speed governor wirings; Check unload input port wirings;